



EVA
I M P E X

Our Range of Best Selling Instruments
GENERAL INSTRUMENTS CATALOGUE

www.eva-impex.com

INSTRUCTIONS FOR REPROCESSING OF REUSABLE SURGICAL INSTRUMENTS

The following instructions are for all reusable medical devices supplied by EVA Instruments Ltd, unless stated otherwise with the packaging of the product. These instructions are intended for use only by persons with the required specialist knowledge and training.

Warnings

- Follow instructions and warnings as issued by the manufacturers of any decontaminants, disinfectants and cleaning agents. Wherever possible avoid use of mineral acids and harsh, abrasive agents.
- No part of the process shall exceed 140 °C.
- Some sensitive materials (e.g. Aluminium) are damaged by high alkaline solutions (pH>10).
- Devices with long, narrow cannula, hinges and blind holes require particular attention during cleaning.

Note: When reprocessing medical devices, always handle with care, wearing protective clothing, gloves and eye-wear in accordance with local health & safety procedures.

Limitations on Reprocessing

- Repeated processing has minimal effect on these instruments.
- End of life normally determined by wear and damage in use.
- Any specific limitations on the number of reprocessing cycles shall be made available with instrument.

From Point of Use

Whenever possible, do not allow blood, debris or bodily fluids to dry on instruments. For best results and to prolong the life of the medical device reprocess immediately after use. If they cannot be reprocessed immediately, use an enzymatic foam spray cleaner to help prevent soil from drying.

Preparation for Decontamination

- Process all the instruments as soon as it is reasonably practical following use.
- Disassemble only where intended, without the use of tools unless specifically provided by the manufacturer. Instructions for dis assembly are available with the device, where required.

Cleaning: Automated

- Use only either CE marked or validated washer-disinfector machines and low foaming, non-ionizing cleaning agents and detergents following the manufacturer's instructions for use, warnings, concentrations and recommended cycles.
- Load instruments carefully, with any box joints and hinges open and so that any fenestration in instruments can drain.
- Place heavy instruments with care in the bottom of containers, taking care not to overload wash baskets.
- Place instruments with concave surfaces facing down to prevent pooling of water.
- Where possible, use appropriate attachments to flush inside reamers and devices with lumens or cannula.
- Ensure that soft, high purity water which is controlled for bacterial endo-toxins is used in the final rinse stage.

Note: Automated cleaning may not be suitable for all lumens and cannula in which case clean manually with a water jet gun, if available, and an appropriate brush (and stilette if provided) that reaches the depth of the feature. After manually cleaning, pass all devices through an automatic cleaning cycle to achieve disinfection.

Note: These instruments have been validated using a washer-disinfector cycle validated to include two cold rinses at <35 °C, a detergent cycle and a rinse cycle both at >50°C, a disinfection cycle operating at a temperature of between 80 °C and 90 °C for a minimum holding time of 1 minute (actual holding time in excess of 2 minutes 50 seconds) and a 20 minute drying cycle. The detergent used was low foaming, non-ionizing spray wash detergent cleaner (max 12pH) and the rinse aid a neutral pH low foaming, non-ionic surfactant with isopropyl alcohol.

Cleaning: Manual

- Manual cleaning is not advised if an automatic washer-disinfector is available. If the equipment is not available, use the following process:-
1. Use a double sink system (wash/rinse) dedicated for instrument cleaning (not used for hand washing). Ensure that the water temperature does not exceed 35 of the re-processor to ensure that the reprocessing as actually performed using equipment, materials and personnel in the reprocessing facility achieve the desired result. This requires validation and routine monitoring of the process. Likewise any deviation by the re-processor from the instructions provided must be properly evaluated for effectiveness and potential adverse consequences.
 2. In the first sink, keeping the instrument submerged, with an autoclavable brush, apply CE marked cleaning solution to all surfaces until all soil has been removed. Pay particular attention to serrations, teeth, ratchets and hinges, always brushing away from the body and avoiding splashing. Ensure rongeurs and hinged instruments are thoroughly cleaned in both open and closed positions.
 3. In the second sink, rinse instruments thoroughly with soft, high purity water which is controlled for bacterial endotoxins, so that the water reaches all parts of the instrument, then carefully hand dry or use a drying cabinet.

Note: Manual Cleaning is NOT a disinfection process: When manual cleaning is used it may not be possible to disinfect the device prior to further handling.

Cleaning Inspection

- After cleaning visually inspect, visually inspect all surfaces, cannulations, ratchets, joints, holes and lumens for complete removal of soil and fluids. If ANY soil or fluid is still visible, return the instrument for repeat decontamination.

Maintenance

- Apply surgical grade lubricant to hinges, joints and moving parts as per the lubricant manufacturer's instructions.

Continued on next page

Inspection and Functional Testing

- Visually inspect and check: - all instruments for damage and wear; cutting edges are free from nicks and present a continuous edge; jaws and teeth align correctly; all articulated instruments have a smooth movement without excess play; locking mechanisms (such as ratchets) fasten securely and close easily; long, slender instruments are not distorted; any component parts fit and assemble correctly with mating components.
- Remove for repair and replacement any blunt, worn out, flaking, fractured or damaged instruments.

Note: If an instrument is returned to the manufacturer / supplier, the instrument must be decontaminated and sterilized and be accompanied with the relevant documented evidence.

Packaging

- All instruments to be packed following local protocol in accordance with ISO 11607-1 or AAMI/CSR technique.

Sterilization (USA)

- Autoclave should comply with the requirements of, and be validated and maintained in accordance with ANSI/AAMI ST79.
- Pre-Vacuum moist heat sterilization operating at temperature 132 °C bar for a minimum holding time of 4 minutes always following the instructions of the machine manufacturer.
- When sterilizing multiple instruments in one autoclave cycle, ensure that the sterilizer manufacturers stated maximum load is not exceeded.
- Ensure instruments are dry before sterilization.

Sterilization (Outside USA)

- Autoclave should comply with the requirements of, and be validated and maintained in accordance with EN 285, EN 13060, EN ISO 17665.
- Either CE marked or validated vacuum autoclave operating at 134-137 °C bar for a minimum holding time of 3 minutes always following the instructions of the machine manufacturer.
- When sterilizing multiple instruments in one autoclave cycle, ensure that the sterilizer manufacturers stated maximum load is not exceeded.

Storage

- Ensure instruments are dry before storage, and stored in dry, clean conditions at an ambient room temperature.

Additional Information

- Other forms of cleaning (i.e. ultrasonic) and sterilization (i.e. Low temperature steam and Formaldehyde, Ethylene Oxide and Gas Plasma) are available. However, always follow the instructions for use as issued by the manufacturer and always consult with them if in any doubt over the suitability of any process used.
- Cleaning and sterilizing guidelines are available in HTM 2030 and HTM 2010. Contact: The NHS Estates Stationers Office Publications Cent for details at www.tsonline.gov.uk. For further information contact: NHS Estates Information Center, Department of Health, 1 Trevelyan Square, Boar Lane, Leeds, LS1 6AE, UK or visit www.nhsestates.gov.uk.

Note: It is the responsibility of the re-processor to ensure that the reprocessing as actually performed using equipment, materials and personnel in the reprocessing facility achieve the desired result. This requires validation and routine monitoring of the process. Likewise any deviation by the re-processor from the instructions provided must be properly evaluated for effectiveness and potential adverse consequences.



Scalpel Handles
Skalpellgriffe
Mangos de bisturios
Manches pour bistouris
Manici per bisturi



EI-010-03
Scalpel Handle # 3
Solid
Overall Length
12 cm (4 3/4")



EI-010-04
Scalpel Handle # 4
Solid
Overall Length
13.5 cm (5 1/4")



EI-012-03
Scalpel Handle # 3
Solid, CM Graduation
Overall Length
12 cm (4 3/4")



EI-020-13
Scalpel Handle # 3L
Solid, Long
Overall Length
21.5 cm (8 1/2")



EI-020-14
Scalpel Handle # 4L
Solid, Long
Overall Length
21 cm (8 1/4")

Scalpel Handles
Skalpellgriffe
Mangos de bisturios
Manches pour bistouris
Manici per bisturi



EI-021-13
Scalpel Handle # 3L
Solid, Angled, Long
Overall Length 21 cm (8 ¼")

EI-021-14
Scalpel Handle # 4L
Solid, Angled, Long
Overall Length 21 cm (8 ¼")

EVA

SCALPEL, KNIVES

Scalpel Handles
Skalpellgriffe
Mangos de bisturias
Manches pour bistouris
Manici per bisturi



EI-030-07
Scalpel Handle # 7
Solid, Also Known as 5
Overall Length 16 cm (6 1/4")



EI-030-17
Scalpel Handle # 7K
Solid, Short
Overall Length 12.5 cm (5")



EI-032-08
Collin Scalpel Handle # 8
With Hollow Handle
Overall Length 13.5 cm (5 1/4")



EI-032-09
Collin Scalpel Handle # 9
With Hollow Handle
Overall Length 14.5 cm (5 3/4")

Scalpel Handles
Skalpgriffe
Mangos de bisturios
Manches pour bistouris
Manici per bisturi

EVA

SCALPEL, KNIVES



EI-050-03
Scalpel Handle # 3
With Round Hollow Handle
Overall Length 15.5 cm (6")



EI-052-03
Scalpel Handle # 3
With Round Handle
Overall Length 14.5 cm (5 ¾")



EI-053-03
Scalpel Handle # 3
Solid, Round Handle, Angled
Overall Length 14 cm (5 ½")



EI-056-03
Kaye Scalpel Handle # 3
Solid, Round Handle
Overall Length 15 cm (6")

Scalpel Blades
Skalpellklingen
Hojas de bisturíes
Lames pour bistouris
Lame per bisturi

Scalpel Blades
Pack of 100



EI-100-10
Fig. 10



EI-100-11
Fig. 11

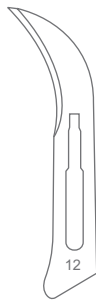

EI-100-12
Fig. 12



EI-100-13
Fig. 13

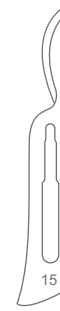

EI-100-15
Fig. 15



EI-100-16
Fig. 16



EI-100-17
Fig. 17

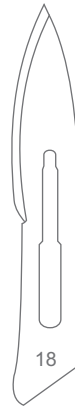

EI-100-18
Fig. 18

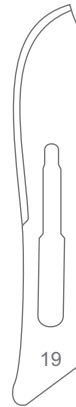

EI-100-19
Fig. 19

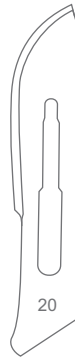

EI-100-20
Fig. 20



EI-100-21
Fig. 21



EI-100-22
Fig. 22



EI-100-23
Fig. 23

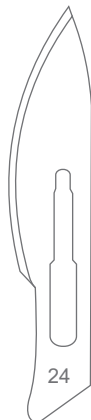

EI-100-24
Fig. 24



EI-100-34
Fig. 34



EI-101-12
Fig. 12D



EI-101-15
Fig. 15C

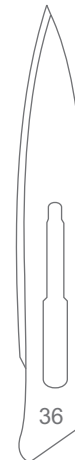

EI-100-36
Fig. 36

Scalpel Handles
Skalpgriffe
Mangos de bisturios
Manches pour bistouris
Manici per bisturi

EVA

SCALPEL, KNIVES



EI-204-00
Caspar Scalpel Handle
Overall Length 13.5 cm (5 1/4")



EI-206-10
10 cm (4")
EI-206-13
13 cm (5")
EI-206-15
15 cm (6")

Beaver Scalpel Handle
For Micro Scalpel Blades

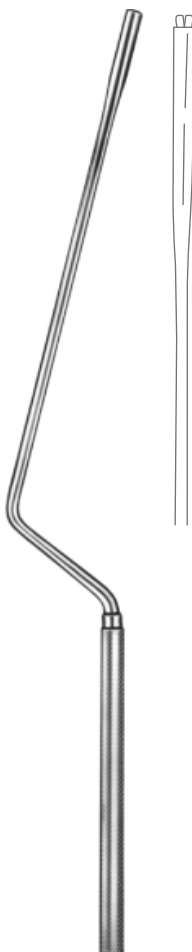

EI-207-00
Landolt Scalpel Handle
Bayonet Shaped, Round Handle
Overall Length 25 cm (10")



EI-209-00
Landolt Scalpel Handle
Bayonet Shaped, Square Handle
Overall Length 21 cm (8 1/4")

Scalpel Blades
 Skalpellklingen
 Hojas de bisturios
 Lames pour bistouris
 Lame per bisturi

Scalpel Micro Blades
 Pack of 25



EI-210-61
 Fig. 61



EI-210-62
 Fig. 62



EI-210-63
 Fig. 63



EI-210-64
 Fig. 64



EI-210-65
 Fig. 65



EI-210-66
 Fig. 66



EI-210-67
 Fig. 67



EI-210-68
 Fig. 68



EI-210-69
 Fig. 69

Operating Knives
Operating Skalpelle
Bisturios para operaciones
Bistouris pour opérations
Bisturi per interventi

EVA

SCALPEL, KNIVES



EI-350-01
Bellied Blade
Fig. 1



EI-350-03
Bellied Blade
Fig. 3



EI-350-04
Bellied Blade
Fig. 4



EI-350-06
Bellied Blade
Fig. 6



EI-350-07
Bellied Blade
Fig. 7



EI-350-08
Bellied Blade
Fig. 8



EI-350-09
Bellied Blade
Fig. 9



EI-350-14
Sharp Pointed Blade
Fig. 14



EI-361-46
Sickle Pointed Blade
Fig. 46

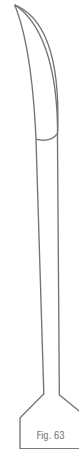

EI-361-46
Tenotome
Fig. 63

EI-350-01
Operating Knife
Bellied Blade, Fig. 1
Overall Length 14 cm (5 1/2")

Post Mortem Knives
Organmesser
Cuchillos para órganos
Couteaux à autopsie
Coltli per autopsia



EI-400-10
Virchow Autopsy Knife
With Wooden Handle, Blade Size 100 mm
Overall Length 25.5 cm (10")



EI-402-08
Virchow Cartilage Knife
With Wooden Handle, Blade Size 80 mm
Overall Length 21 cm (8 ¼")



EI-410-11
Blade Size 110 mm
26 cm (10 ¼")

EI-410-14
Blade Size 140 mm
29 cm (11 ½")

EI-410-17
Blade Size 170 mm
31 cm (12 ¼")

Walb Post Mortem Knife
With Wooden Handle

Amputation Knives
Amputationsmesser
Cuchillos para amputación
Couteaux à amputation
Coltelli per amputazione



EI-420-16

Blade Size 160 mm
26 cm (10 1/4")

EI-420-20

Blade Size 200 mm
33.5 cm (13 1/4")

EI-420-24

Blade Size 240 mm
38 cm (15")

Virchow Brain Knife
With Hollow Handle



EI-450-13

Blade Size 130 mm
26 cm (10 1/4")

EI-450-16

Blade Size 160 mm
29 cm (11 1/2")

EI-450-19

Blade Size 190 mm
32.5 cm (12 3/4")

EI-450-22

Blade Size 220 mm
35 cm (13 3/4")

Liston Amputation Knife
With Hollow Handle

Amputation Knives
Amputationsmesser
Cuchillos para amputación
Couteaux à amputation
Coltelli per amputazione



EI-460-16
Catlin Amputation Knife
With Hollow Handle
Blade Size 160 mm
Overall Length 29 cm (11 1/2")



EI-470-12
Langenbeck Flap Knife
Blade Size 120 mm
Overall Length 25 cm (9 3/4")



EI-472-10
Phalangeal Knife
Blade Size 150 mm
Overall Length 23.5 cm (9 1/4")



EI-474-11
Interosseous Knife
Blade Size 110 mm
Overall Length 24 cm (9 1/2")

Amputation Knives
Amputationsmesser
Cuchillos para amputación
Couteaux à amputation
Coltelli per amputazione

EVA

SCALPEL, KNIVES



EI-480-65
Resection Knife
Solid Handle
Dissecting End, Blade Size 65 mm
Overall Length 19 cm (7 ½")



EI-482-55
Langenbeck Resection Knife
Blade Size 55 mm
Overall Length 18 cm (7")



EI-484-55
Langenbeck Resection Knife
Blade Size 55 mm
Overall Length 18 cm (7")

Fistula Knives
Fistelmesser
Bisturías para fistulas
Bistouris à fistules
Bisturi per fistole



EI-488-01
Simon Fistula Knife
Fig. 1
Overall Length 20 cm (8")



EI-488-01
Fig. 1



EI-488-02
Fig. 2



EI-488-03
Fig. 3



EI-490-22
Ulrich Fistula Knife
Overall Length 22.5 cm (9")



EI-490-22
Ulrich Fistula Knife
Overall Length 20.5 cm (8")

Tonsil Knives
Tonsillenmesser
Bisturies para amígdalas
Bistouris pour amygdales
Bisturi per tonsille



EI-494-23
Trigeminal Knife
Overall Length 23 cm (9")



EI-501-20
Fowler Tonsil Knife
Overall Length 20 cm (8")



EI-503-21
Abraham Tonsil Knife
Overall Length 21 cm (8 1/4")



EI-505-13
Masing Cartilage Slitting Knife
Overall Length 13 cm (5")

Dermatomes
Dermatome
Dermátoms
Dermatomes
Dermatomi

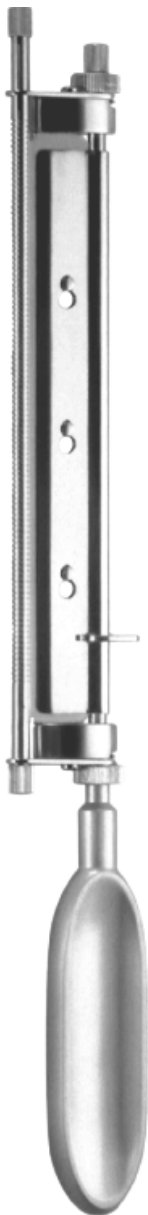

EI-700-32
Humby Skin Graft Knife (Dermatome)
Thickness Adjustable From 0.1 to 1.2 mm
Cutting Width Maximum 155 mm
Overall Length 32 cm (13")

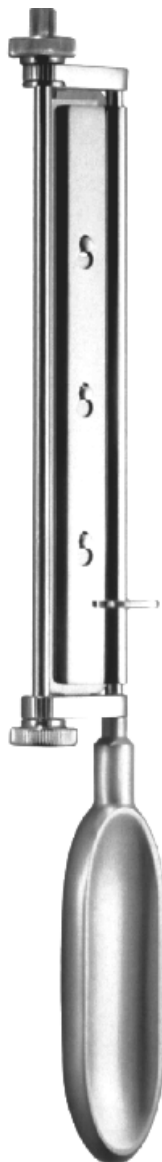

EI-710-30
Watson Skin Graft Knife (Dermatome)
Thickness Adjustable From 0.1 to 1.2 mm
Cutting Width Maximum 155 mm
Overall Length 30.5 cm (12")



EI-712-00
Skin Graft Knife Blade (Dermatome Blade)
For EI-700-32 and EI-710-30
Overall Length 15 cm (6")

Dermatomes
Dermatome
Dermátoms
Dermatomes
Dermatomi

EVA

SCALPEL, KNIVES

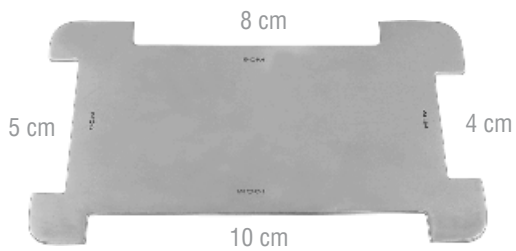

EI-734-00

Skin Fixation Plate

4 cm, 5 cm, 8 cm, 10 cm



EI-740-19

Silver Skin Graft Knife (Dermatome)

Thickness Adjustable From 0.1 to 1.2 mm, Cutting Width
Maximum 40 mm
Overall Length 19 cm (7 1/2")

Aorta Punches
Aortastanzen
Perforadores aórticos
Rongeurs pour aorte
Pinze taglienti per aorta

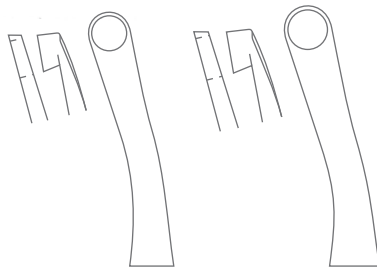

EI-801-04
Ø 4.0 mm

EI-801-05
Ø 5.0 mm

Karp Aorta Punch
Overall Length 16 cm (6 1/4")



EI-804-28
Ø 2.8 mm



EI-804-40
Ø 4.0 mm



EI-804-45
Ø 4.5 mm



EI-804-50
Ø 5.0 mm



EI-804-60
Ø 6.0 mm

Aorta Punch
Overall Length 14 cm (5 1/2")

Blade Holders / Blade Breakers
 Klingenhalter / Kingenbrecher
 Porta-hojas / Rompe-hojas de afeitador
 Pincettes pour saisir et casser les lames de rasoir
 Pinze per afferrare e rompere le lamette de rasoio

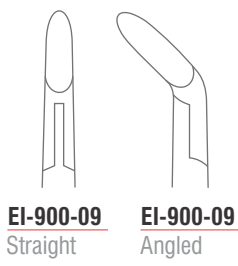

EI-900-09
Straight
EI-900-09
Angled

EI-900-09
Troutman-Chris Blade Holder/Breaker
Round Handle, Straight
Overall Length 9 cm (3 1/2")



EI-900-09
Barraquer Blade Holder/Breaker
Overall Length 11 cm (4 1/4")



EI-900-09
Castroviejo Blade Holder/Breaker
Round Handle
Overall Length 13 cm (5")

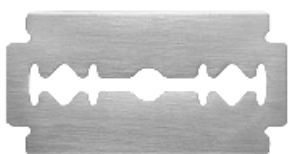

EI-900-09
Silver Skin Graft Knife Blade
Pack of 10
Standard

Operating Scissors
Chirurgische Scheren
Tijeras quirúrgicas
Ciseaux chirurgicaux
Forbici per chirurgia



Operating Scissors
Straight, Blunt/Blunt

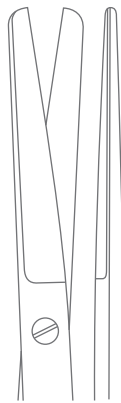

EI-002-11
12 cm (4 3/4")

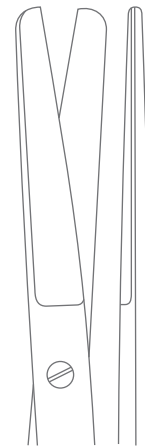

EI-002-13
13 cm (5")

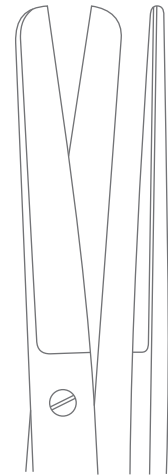

EI-002-14
14.5 cm (5 3/4")

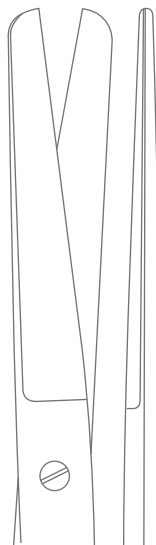

EI-002-16
16.5 cm (6 1/2")

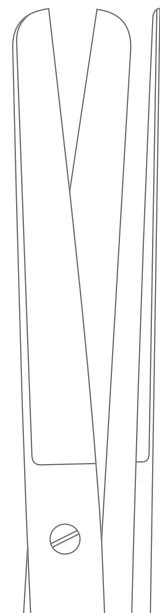

EI-002-18
18.5 cm (7 1/4")

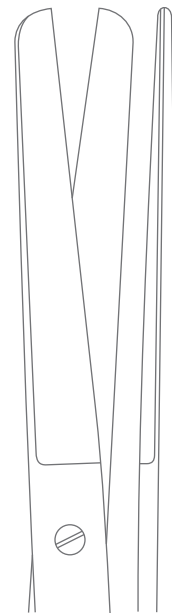

EI-002-20
20.5 cm (8")

Operating Scissors
Chirurgische Scheren
Tijeras quirúrgicas
Ciseaux chirurgicaux
Forbici per chirurgia



Operating Scissors
Curved, Blunt/Blunt



EI-003-11
12 cm (4 3/4")



EI-003-13
13 cm (5")

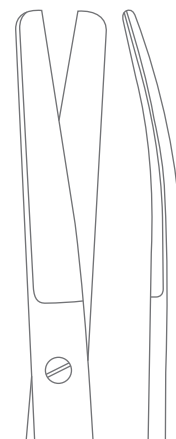

EI-003-14
14.5 cm (5 3/4")



EI-003-16
16.5 cm (6 1/2")



EI-003-18
18.5 cm (7 1/4")



EI-003-20
20.5 cm (8")

Operating Scissors
Chirurgische Scheren
Tijeras quirúrgicas
Ciseaux chirurgicaux
Forbici per chirurgia



Operating Scissors
Straight, Sharp/Blunt

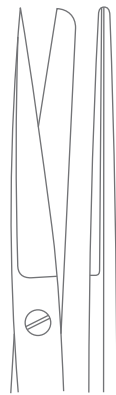

EI-004-11
12 cm (4 3/4")

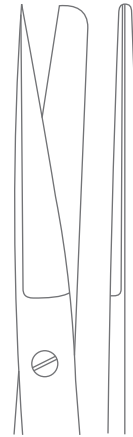

EI-004-13
13 cm (5")

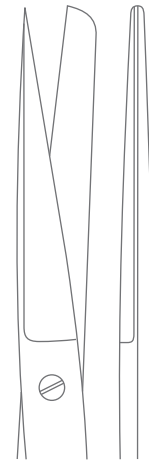

EI-004-14
14.5 cm (5 3/4")

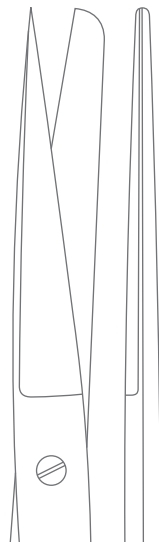

EI-004-16
16.5 cm (6 1/2")

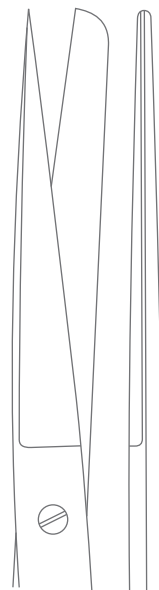

EI-004-18
18.5 cm (7 1/4")

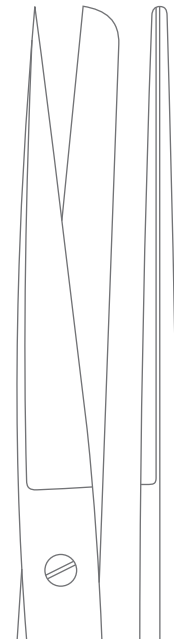

EI-004-20
20.5 cm (8")

Operating Scissors
Chirurgische Scheren
Tijeras quirúrgicas
Ciseaux chirurgicaux
Forbici per chirurgia

EVA

SCISSORS

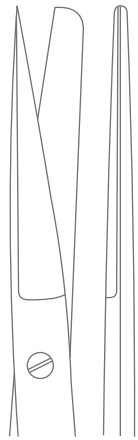

EI-004-13 SC
13 cm (5")

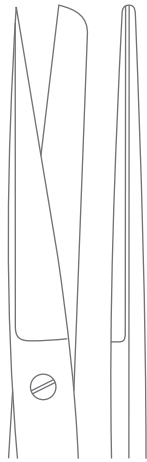

EI-004-14 SC
14.5 cm (5 3/4")

Operating Scissors
Straight, Sharp/Blunt

SUPEREdge™

Operating Scissors
Chirurgische Scheren
Tijeras quirúrgicas
Ciseaux chirurgicaux
Forbici per chirurgia



Operating Scissors
Curved, Sharp/Blunt

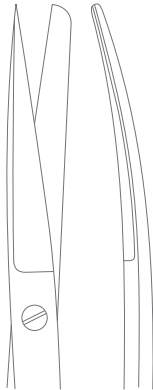

EI-005-11
12 cm (4 ¾")

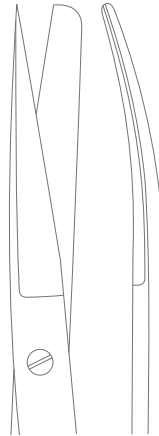

EI-005-13
13 cm (5")



EI-005-14
14.5 cm (5 ¾")

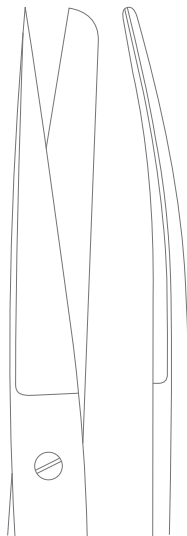

EI-005-16
16.5 cm (6 ½")



EI-005-18
18.5 cm (7 ¼")

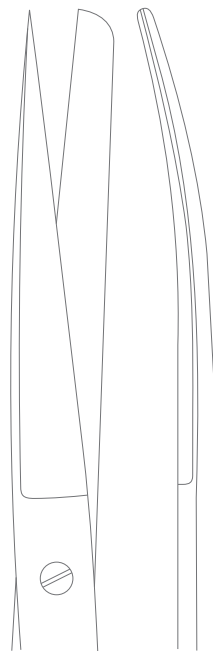

EI-005-20
20.5 cm (8")

Operating Scissors
Chirurgische Scheren
Tijeras quirúrgicas
Ciseaux chirurgicaux
Forbici per chirurgia

EVA

SCISSORS

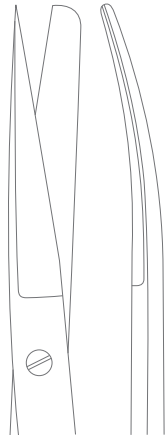

EI-005-13 SC
13 cm (5")



EI-005-14 SC
14.5 cm (5 3/4")

Operating Scissors
Curved, Sharp/Blunt

SUPEREdge™

Operating Scissors
Chirurgische Scheren
Tijeras quirúrgicas
Ciseaux chirurgicaux
Forbici per chirurgia



Operating Scissors
Straight, Sharp/Sharp

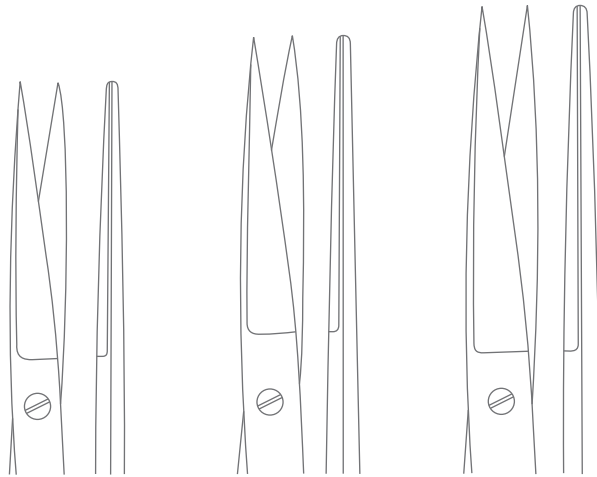

EI-006-11
12 cm (4 3/4")

EI-006-13
13 cm (5")

EI-006-14
14.5 cm (5 3/4")

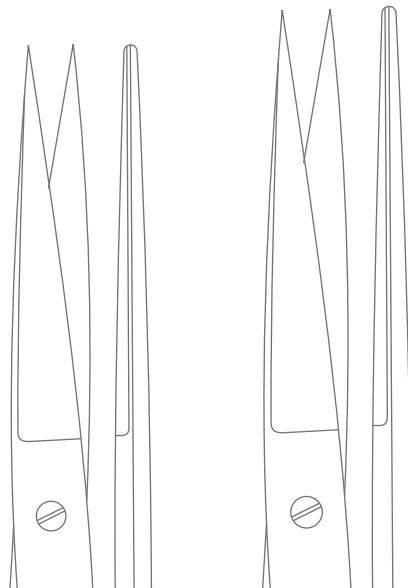

EI-006-16
16.5 cm (6 1/2")

EI-006-18
18.5 cm (7 1/4")

Operating Scissors
Chirurgische Scheren
Tijeras quirúrgicas
Ciseaux chirurgicaux
Forbici per chirurgia

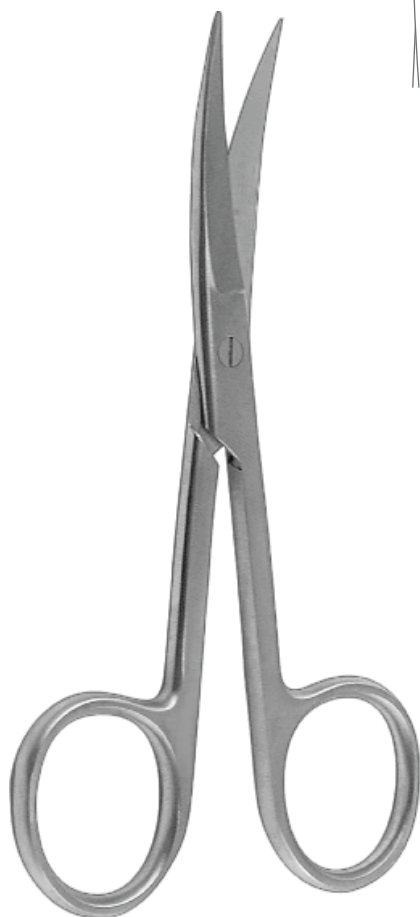

Operating Scissors
Curved, Sharp/Sharp

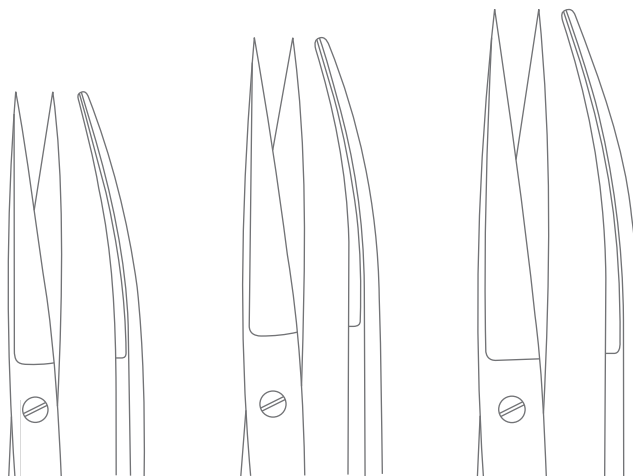

EI-007-11
12 cm (4 ¾")

EI-007-13
13 cm (5")

EI-007-14
14.5 cm (5 ¾")

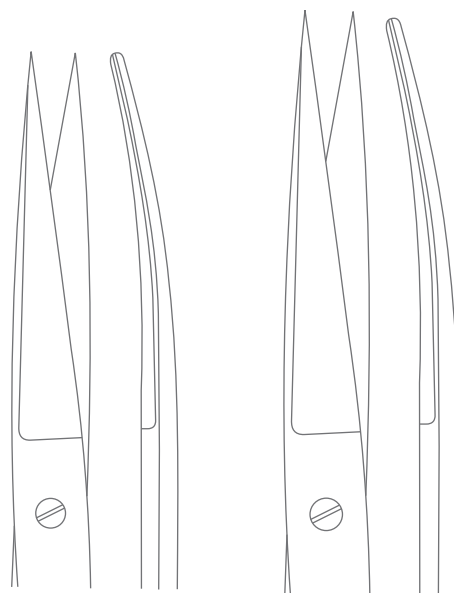

EI-007-16
16.5 cm (6 ½")

EI-007-18
18.5 cm (7 ¼")

Operating Scissors
Chirurgische Scheren
Tijeras quirúrgicas
Ciseaux chirurgicaux
Forbici per chirurgia



Operating Scissors
Slender Pattern Blunt/Blunt
Overall Length 14.5 cm (5 ¾")

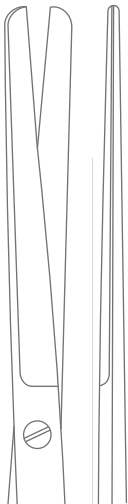

EI-010-14
Straight
Blunt/Blunt



EI-011-14
Curved
Blunt/Blunt



EI-012-14
Straight
Sharp/Blunt

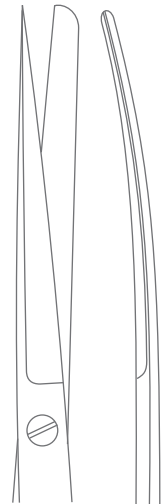

EI-013-14
Curved
Sharp/Blunt

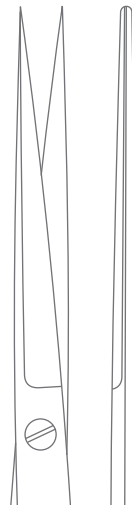

EI-014-14
Straight
Sharp/Sharp



EI-015-14
Curved
Sharp/Sharp

Operating Scissors
Chirurgische Scheren
Tijeras quirúrgicas
Ciseaux chirurgicaux
Forbici per chirurgia

EVA

SCISSORS

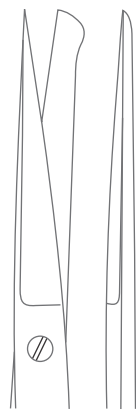
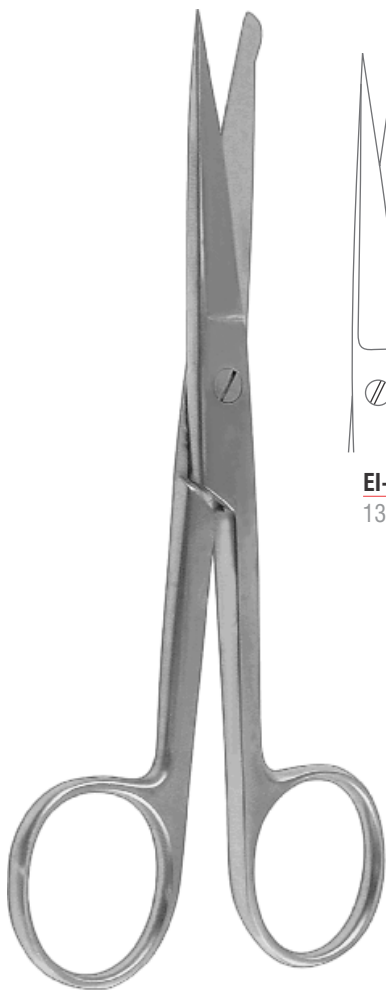

EI-018-13
13 cm (5")

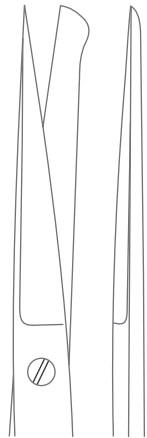

EI-018-13
14.5 cm (5 3/4")

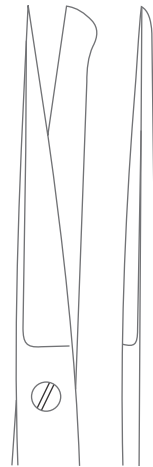

EI-018-13
16.5 cm (5 1/2")

EI-018-13
Incision Scissors
Straight

Operating Scissors
Chirurgische Scheren
Tijeras quirúrgicas
Ciseaux chirurgicaux
Forbici per chirurgia



EI-024-13
Systrunk Nail Splitting Scissor
Straight
Overall Length 13 cm (5")



Deaver Operating Scissor
Sharp/Blunt
Overall Length 14 cm (5 1/2")

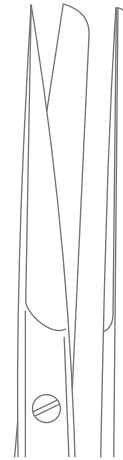

EI-030-14
Straight



EI-031-14
Curved

Operating Scissors
Chirurgische Scheren
Tijeras quirúrgicas
Ciseaux chirurgicaux
Forbici per chirurgia

EVA

SCISSORS



Mayo Dissecting Scissor
Straight



EI-040-14
14.5 cm (5 3/4")



EI-040-15
15 cm (6")



EI-040-17
17 cm (6 3/4")



EI-040-19
19 cm (7 1/2")

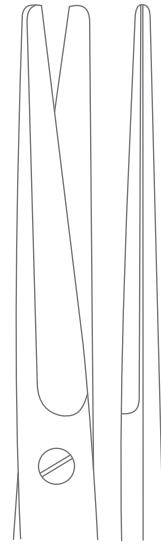

EI-040-23
23.5 cm (9 1/4")

Operating Scissors
Chirurgische Scheren
Tijeras quirúrgicas
Ciseaux chirurgicaux
Forbici per chirurgia



Mayo Dissecting Scissor
Straight

SUPEREdge™



EI-040-14 SC
14.5 cm (5 ¾")



EI-040-15 SC
15 cm (6")



EI-040-17 SC
17 cm (6 ¾")

Operating Scissors
Chirurgische Scheren
Tijeras quirúrgicas
Ciseaux chirurgicaux
Forbici per chirurgia

EVA

SCISSORS



Mayo Dissecting Scissor
Curved



EI-041-14
14.5 cm (5 3/4")



EI-041-15
15 cm (6")



EI-041-17
17 cm (6 3/4")

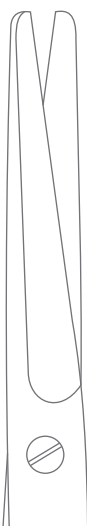

EI-041-19
19 cm (7 1/2")



EI-041-23
23.5 cm (9 1/4")

Operating Scissors
Chirurgische Scheren
Tijeras quirúrgicas
Ciseaux chirurgicaux
Forbici per chirurgia



Mayo Dissecting Scissor
Curved

SUPERedge™

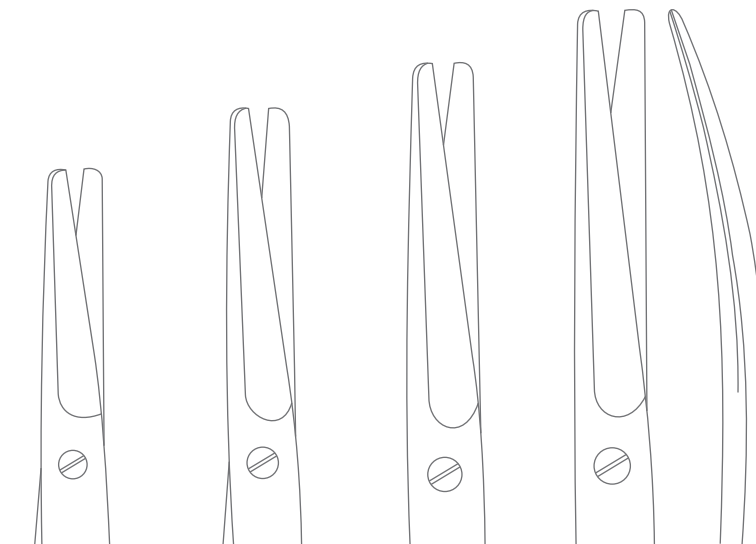

EI-041-14 SC
14.5 cm (5 3/4")

EI-041-15 SC
15 cm (6")

EI-041-17 SC
17 cm (6 3/4")

EI-041-23 SC
23.5 cm (9 1/4")

Dissecting Scissors
Präparierscheren
Tijeras de disección
Ciseaux à dissection
Forbici per dissezione



Mayo Dissecting Scissor
With Chamfered Blades



EI-042-19
Straight
19 cm (7 ½")



EI-042-21
Straight
21.5 cm (8 ½")



EI-043-19
Curved
19 cm (7 ½")



EI-043-21
Curved
21.5 cm (8 ½")

Dissecting Scissors
Präparierscheren
Tijeras de disección
Ciseaux à dissection
Forbici per dissezione

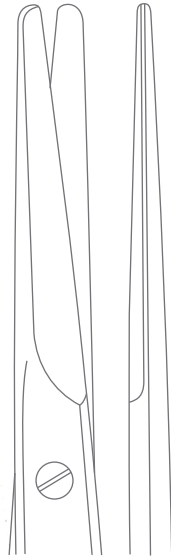

EI-046-23
Straight
23 cm (9")



EI-047-23
Curved
22.5 cm (9")

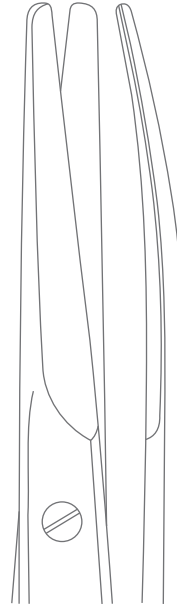

EI-047-28
Curved
28 cm (11")

Mayo-Harrington Dissecting Scissor

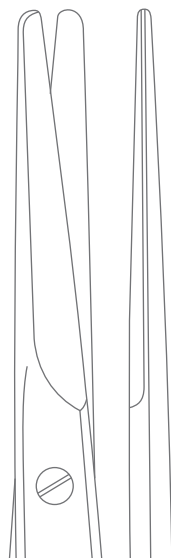

EI-046-23 SC
Straight
23 cm (9")



EI-047-23 SC
Curved
22.5 cm (9")

SUPERedge™

Mayo-Harrington Dissecting Scissor

Dissecting Scissors
Präparierscheren
Tijeras de disección
Ciseaux à dissection
Forbici per dissezione

EVA

SCISSORS



Mayo-Stillie Dissecting Scissor
Straight

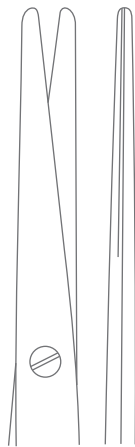

EI-050-15
15 cm (6")

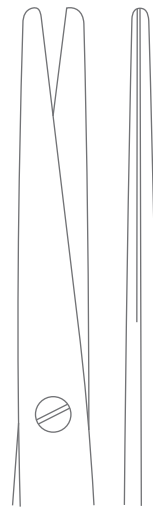

EI-050-17
17 cm (6 3/4")



EI-050-19
19.5 cm (7 3/4")

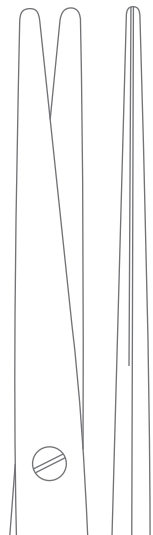

EI-050-21
21.5 cm (8 1/2")

Dissecting Scissors
Präparierscheren
Tijeras de disección
Ciseaux à dissection
Forbici per dissezione

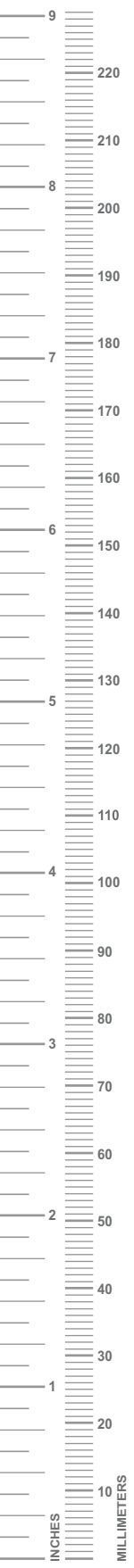

SuperEdge™ Mayo-Stille Dissecting Scissor

SUPEREdge™

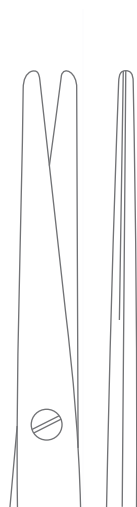

EI-050-15 SC
Straight
15 cm (6")

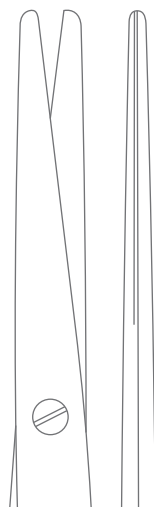

EI-050-17 SC
Straight
17 cm (6 3/4")

Dissecting Scissors
Präparierscheren
Tijeras de disección
Ciseaux à dissection
Forbici per dissezione

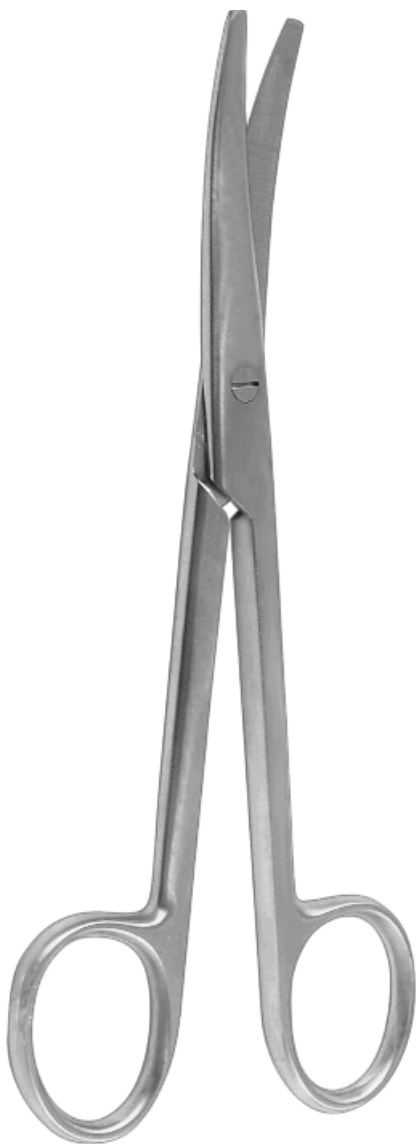

Mayo-Stillie Dissecting Scissor



EI-051-15
Curved
15 cm (6")



EI-051-17
Curved
17 cm (6 ¾")



EI-051-19
Curved
19.5 cm (7 ¾")



EI-051-21
Curved
21.5 cm (8 ½")

Dissecting Scissors
 Präparierscheren
 Tijeras de disección
 Ciseaux à dissection
 Forbici per dissezione



SuperEdge™ Mayo-Style Dissecting Scissor

SUPEREdge™



EI-051-15 SC
 Curved
 15 cm (6")



EI-051-17 SC
 Curved
 17 cm (6 ¾")

Dissecting Scissors
Präparierscheren
Tijeras de disección
Ciseaux à dissection
Forbici per dissezione

EVA

SCISSORS



EI-052-14
Straight
14 cm (5 ½")

EI-052-17
Straight
17 cm (6 ¾")

EI-053-14
Curved
14 cm (5 ½")

EI-053-17
Curved
17 cm (6 ¾")

Mayo-Stillie Dissecting Scissor
With Chamfered Blades

Dissecting Scissors
Präparierscheren
Tijeras de disección
Ciseaux à dissection
Forbici per dissezione

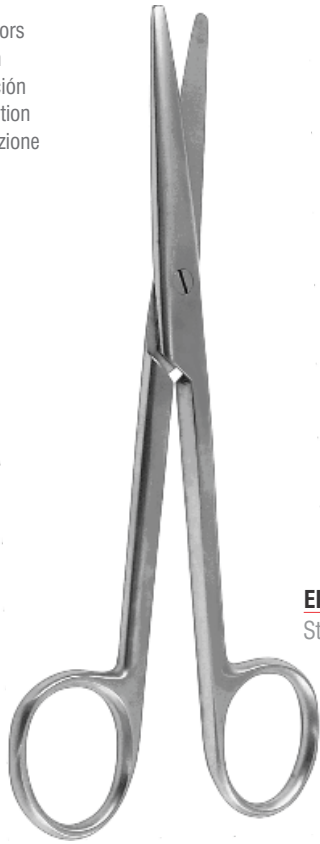

Stille Dissecting Scissor
Overall Length 15 cm (6")

EI-056-15
Straight

EI-057-15
Curved



Mayo-Noble Gynecological Scissor
Overall Length 16.5 cm (6 1/2")

EI-060-17
Straight

EI-061-17
Curved



Gynecological Scissors
Gynäkologische Scheren
Tijeras para ginecología
Ciseaux à gynécologie
Forbici per ginecologia

EVA

SCISSORS

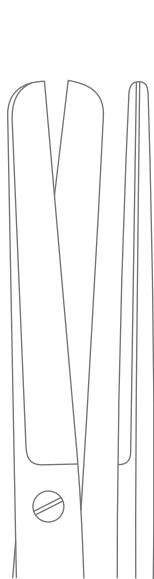

EI-070-20
20 cm (8")

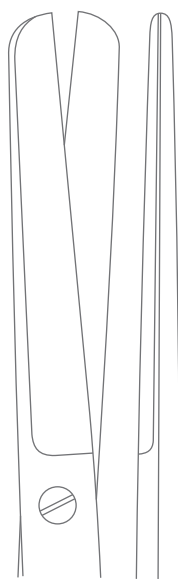

EI-070-23
23 cm (9")

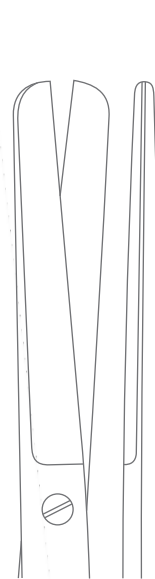

EI-070-20 SC
20 cm (8")

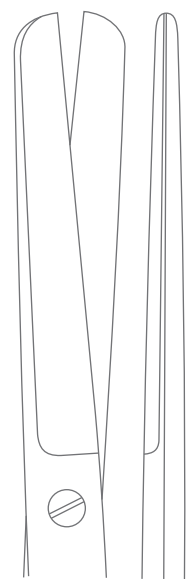

EI-070-23 SC
23 cm (9")

Sims Gynecological Scissor
Straight

SuperEdge™ Sims Gynecological Scissor
Straight

SUPEREdge™

Gynecological Scissors
Gynäkologische Scheren
Tijeras para ginecología
Ciseaux à gynécologie
Forbici per ginecologia



Sims Gynecological Scissor
Straight

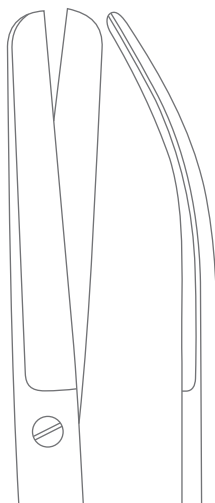

EI-071-20
20 cm (8")



EI-071-23
23 cm (9")

Gynecological Scissors
Gynäkologische Scheren
Tijeras para ginecología
Ciseaux à gynécologie
Forbici per ginecologia

EVA

SCISSORS



EI-071-20 SC
20 cm (8")

EI-071-23 SC
23 cm (9")

SuperEdge™ Sims Gynecological Scissor
Curved



Gynecological Scissors
Gynäkologische Scheren
Tijeras para ginecología
Ciseaux à gynécologie
Forbici per ginecologia

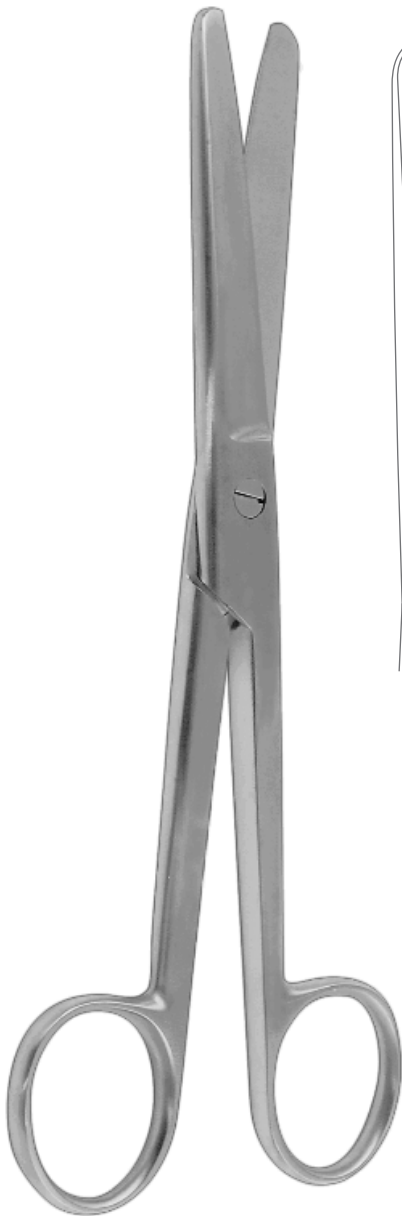

Doyen Gynecological Scissor
Overall Length 18.5 cm (7 1/4")

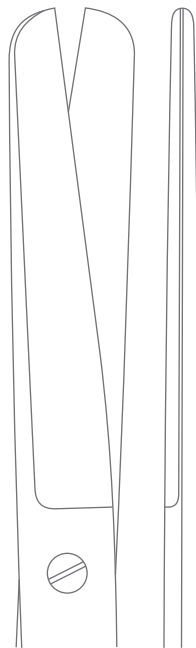

EI-074-17
Straight

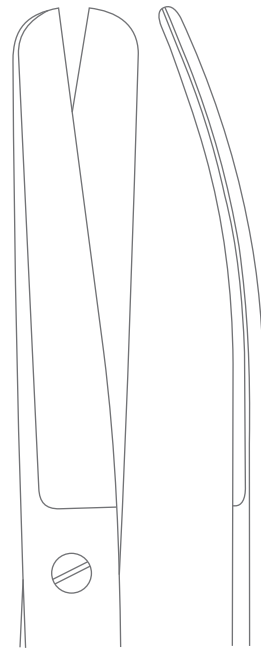

EI-0EI-17
Curved

Gynecological Scissors
Gynäkologische Scheren
Tijeras para ginecología
Ciseaux à gynécologie
Forbici per ginecologia

EVA

SCISSORS

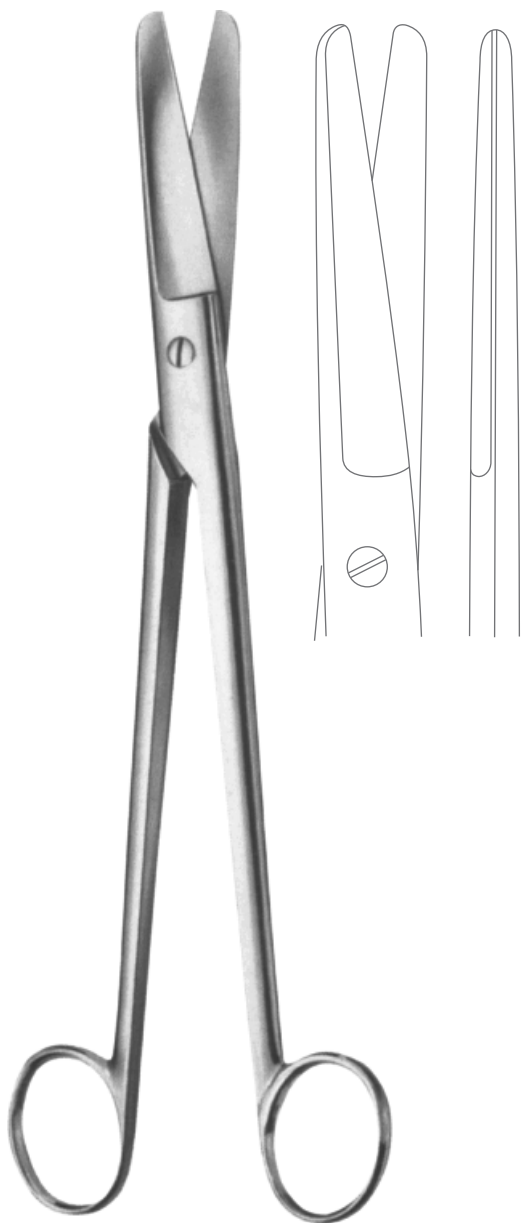

EI-078-24

Sims-Siebold Gynecological Scissor

Straight

Overall Length 24.5 cm (9 3/4")

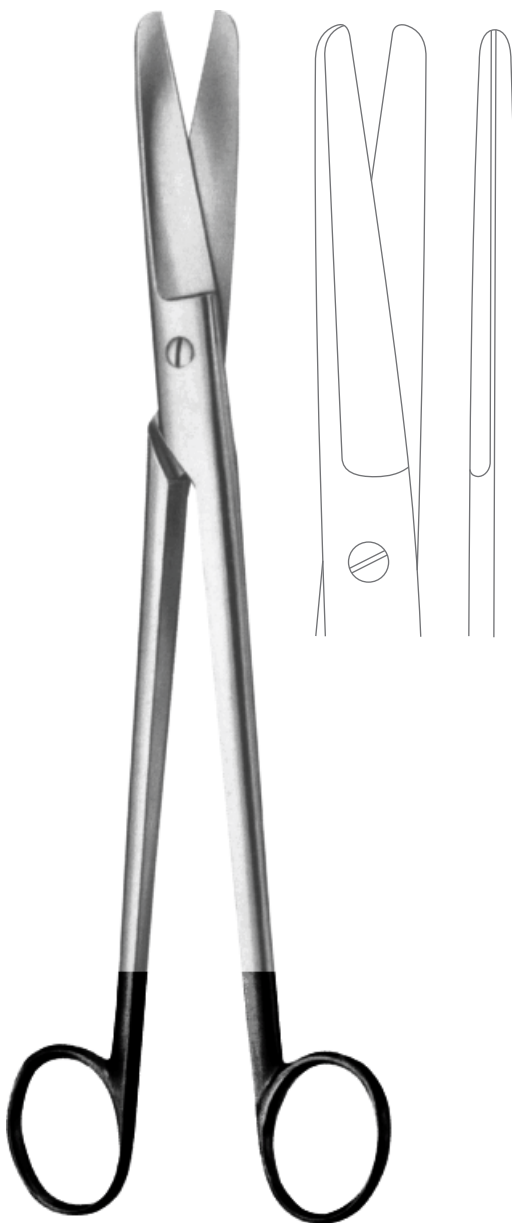

EI-078-24 SC

SuperEdge™ Sims-Siebold Gynecological Scissor

Straight

Overall Length 24.5 cm (9 3/4")

SUPEREdge™

Gynecological Scissors
Gynäkologische Scheren
Tijeras para ginecología
Ciseaux à gynécologie
Forbici per ginecologia



EI-079-24
Sims-Siebold Gynecological Scissor
Curved
Overall Length 24.5 cm (9 3/4")

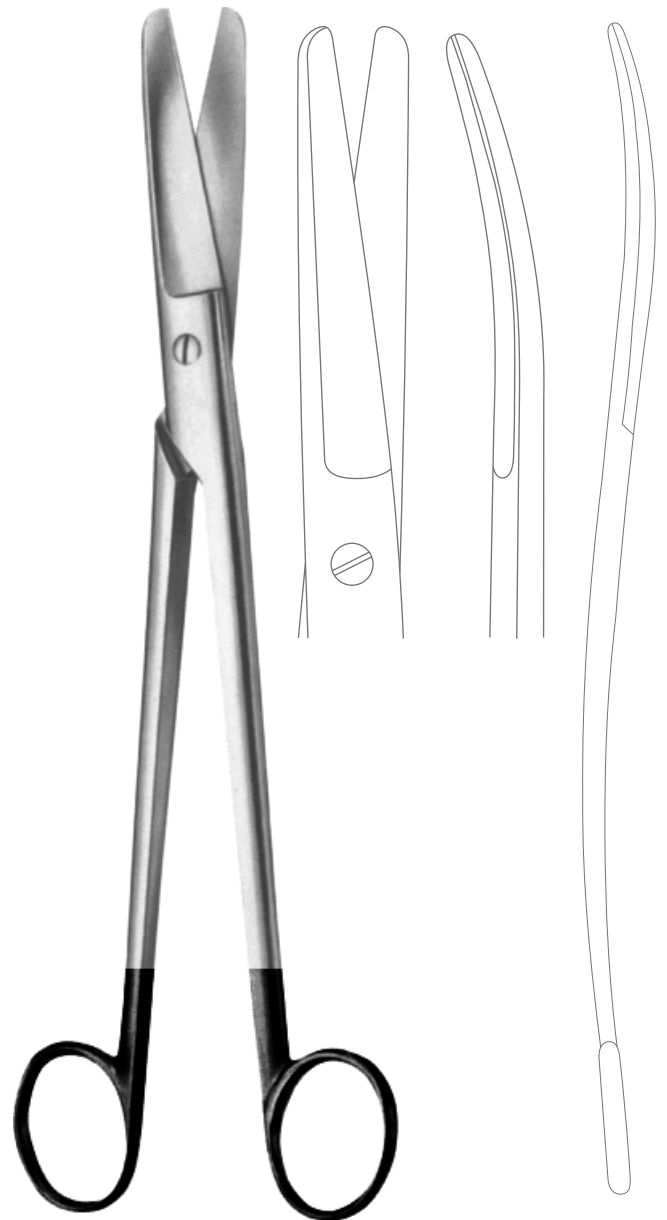

EI-079-24 SC
SuperEdge™ Sims-Siebold Gynecological Scissor
Curved
Overall Length 24.5 cm (9 3/4")

SUPEREdge™

Gynecological Scissors
Gynäkologische Scheren
Tijeras para ginecología
Ciseaux à gynécologie
Forbici per ginecologia

EVA

SCISSORS

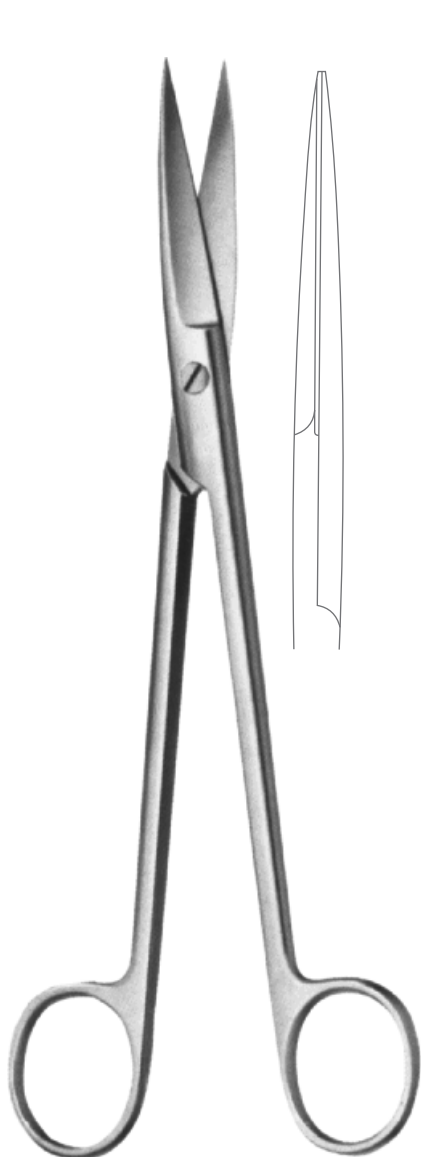

EI-082-20
Sims Gynecological Scissor
Straight, Sharp/Sharp
Overall Length 20 cm (8")

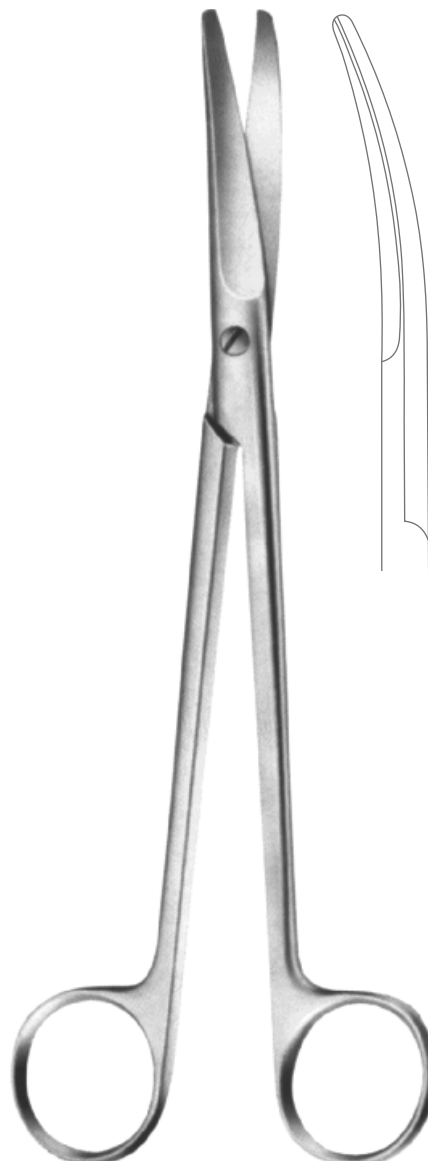

EI-085-21
Sims Gynecological Scissor
Curved, Blunt/Blunt
Overall Length 21 cm (8 1/4")

Gynecological Scissors
Gynäkologische Scheren
Tijeras para ginecología
Ciseaux à gynécologie
Forbici per ginecologia



Wertheim Gynecological Scissor
Curved



EI-087-20
20 cm (8")



EI-087-23
23 cm (9")

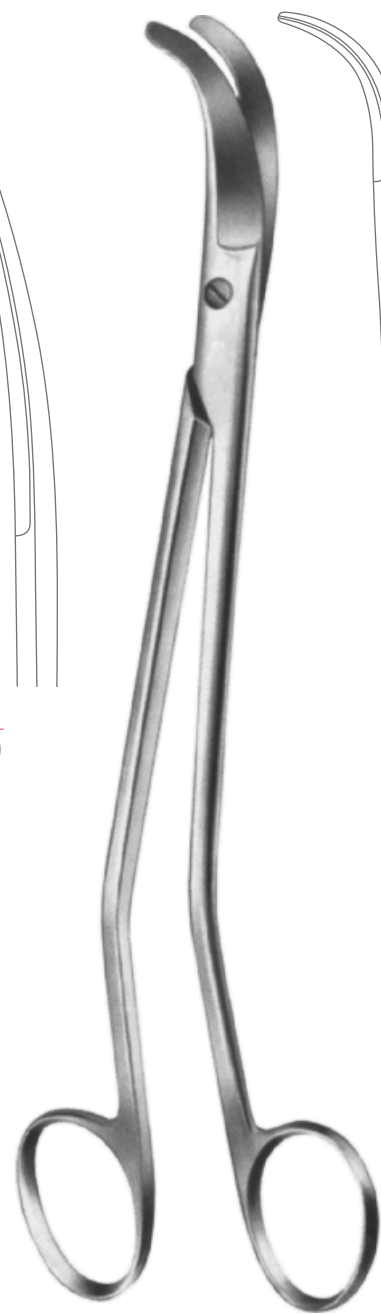

EI-089-22
Bozemmann Gynecological Scissor
S Shaped
Overall Length 22 cm (8 3/4")

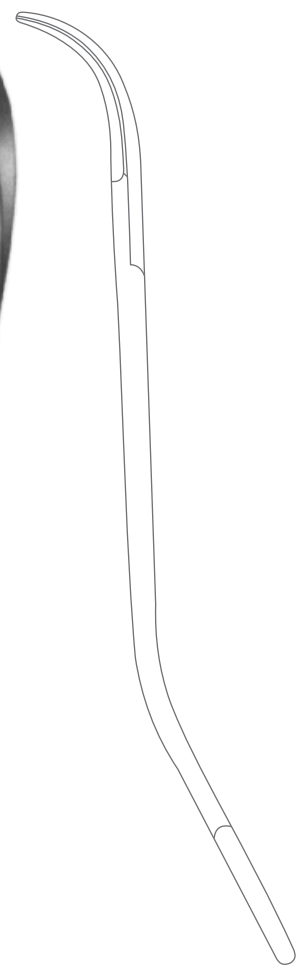

Ophthalmology Instruments
 Ophthalmologie Instrumente
 Oftalmologia Instrumentos
 Ophtalmologie Instruments
 Oftalmologia Strumenti

EVA

SCISSORS



EI-091-24
 24 cm (9 1/2")

Kieback Parametrium Scissor
 Angled 90°
 Overall Length 24 cm (9 1/2")

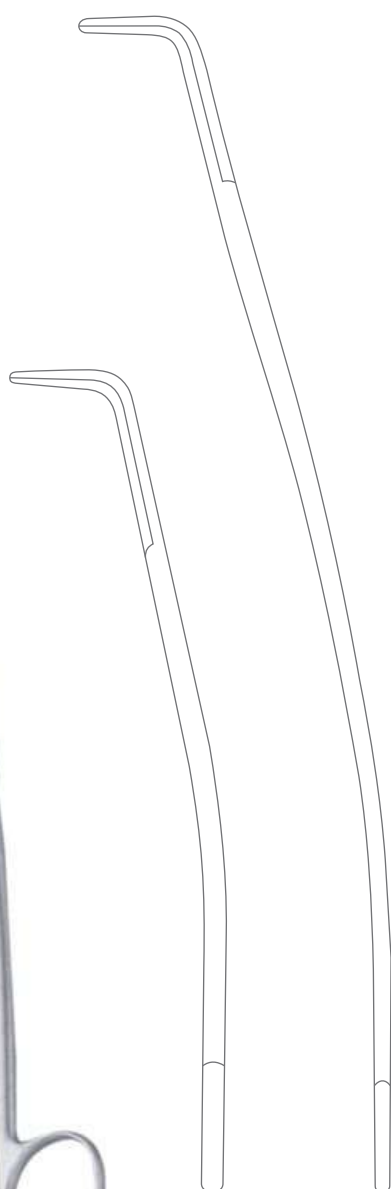

EI-091-24
 35 cm (13 3/4")



EI-093-26
 26 cm (10 1/4")

Kieback Parametrium Scissor
 Curved to Side, One Probe Pointed Blade
 One Toothed Cutting Edge
 22 cm (8 3/4")

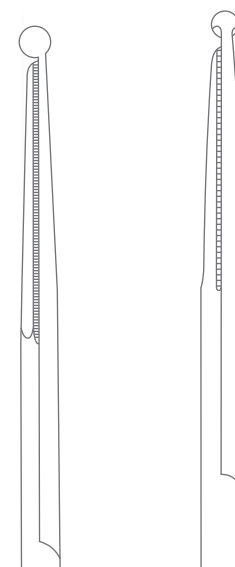

EI-093-26
 35 cm (13 3/4")

Dissecting Scissors
Präparierscheren
Tijeras de disección
Ciseaux à dissection
Forbici per dissezione

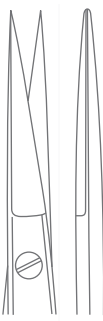

EI-100-16
Straight



EI-101-16
Curved

Kelly Dissecting Scissor
Overall Length 16 cm (6 1/4")

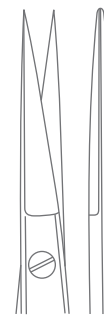

EI-100-16 SC
Straight



EI-101-16 SC
Curved

SuperEdge™ Kelly Dissecting Scissor
Overall Length 16 cm (6 1/4")

SUPEREdge™

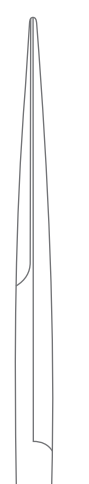

EI-104-15
Straight



EI-105-15
Curved

Joseph Dissecting Scissor
Overall Length 15 cm (6")

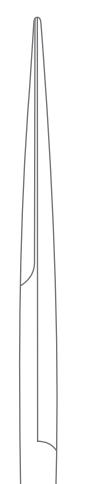

EI-104-15 SC
Straight



EI-105-15 SC
Curved

SuperEdge™ Joseph Dissecting Scissor
Overall Length 15 cm (6")

SUPEREdge™

Dissecting Scissors
Präparierscheren
Tijeras de disección
Ciseaux à dissection
Forbici per dissezione

EVA

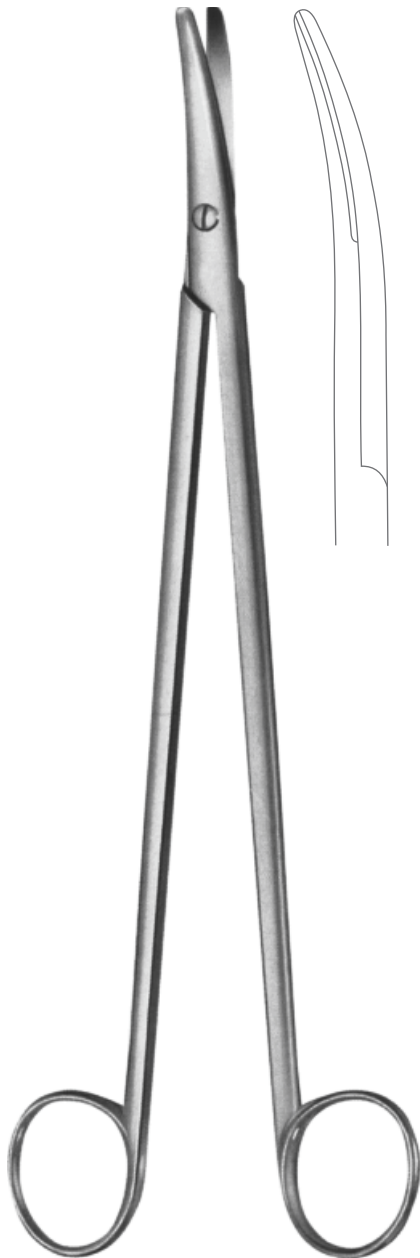

EI-111-28
Weller Dissecting Scissor
Heavy Pattern
Overall Length 28 cm (11")



EI-113-25
Resano Cartilage Scissor
Overall Length 25 cm (9 3/4")

THORAX, CARDIOVASCULAR SURGERY

Dissecting Scissors
Präparierscheren
Tijeras de disección
Ciseaux à dissection
Forbici per dissezione



Metzenbaum Dissecting Scissor
Blunt/Blunt
Overall Length 11.5 cm (4 1/2")

EI-120-11
Straight
Blunt/Blunt

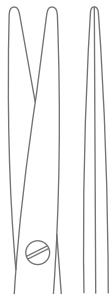

EI-121-11
Curved
Blunt/Blunt



SuperEdge™ Metzenbaum Dissecting Scissor
Blunt/Blunt
Overall Length 11.5 cm (4 1/2")

EI-120-11 SC
Straight
Blunt/Blunt



EI-121-11 SC
Curved



SUPEREdge™

Dissecting Scissors
 Präparierscheren
 Tijeras de disección
 Ciseaux à dissection
 Forbici per dissezione

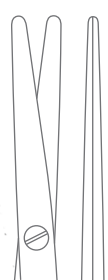

EI-122-15
Straight



EI-123-15
Curved

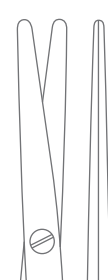

EI-122-15 SC
Straight

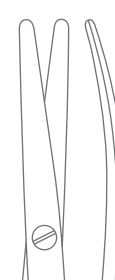

EI-123-15 SC
Curved

SUPEREdge™

Metzenbaum Dissecting Scissor
Blunt/Blunt
Overall Length 15.5 cm (6")

SuperEdge™ Metzenbaum Dissecting Scissor
Blunt/Blunt
Overall Length 15.5 cm (6")

Dissecting Scissors
Präparierscheren
Tijeras de disección
Ciseaux à dissection
Forbici per dissezione



Metzenbaum Dissecting Scissor
Blunt/Blunt
Overall Length 14.5 cm (5 3/4")

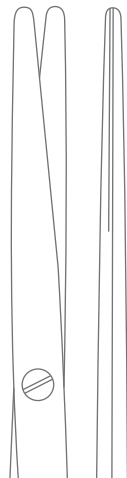

EI-130-14
Straight



EI-131-14
Curved



SuperEdge™ Metzenbaum Dissecting Scissor
Blunt/Blunt
Overall Length 14.5 cm (5 3/4")

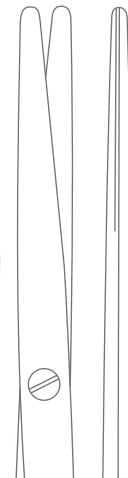

EI-130-14 SC
Straight



EI-131-14 SC
Curved

SUPEREdge™

Dissecting Scissors
 Präparierscheren
 Tijeras de disección
 Ciseaux à dissection
 Forbici per dissezione

THORAX, CARDIOVASCULAR SURGERY

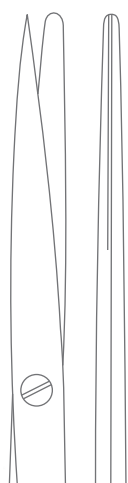

EI-132-14
Straight



EI-133-14
Curved



EI-134-14
Straight

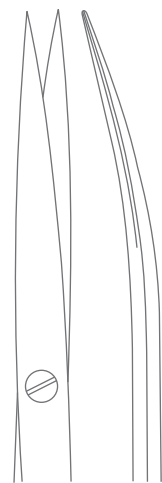

EI-135-14
Curved

Metzenbaum Dissecting Scissor
 Sharp/Blunt
 Overall Length 14.5 cm (5 3/4")

Metzenbaum Dissecting Scissor
 Sharp/Sharp
 Overall Length 14.5 cm (5 3/4")

Dissecting Scissors
 Präparierscheren
 Tijeras de disección
 Ciseaux à dissection
 Forbici per dissezione

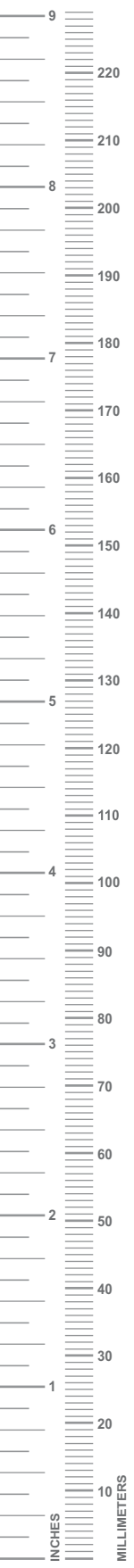

Metzenbaum-Nelson Dissecting Scissor
 Straight, Blunt/Blunt

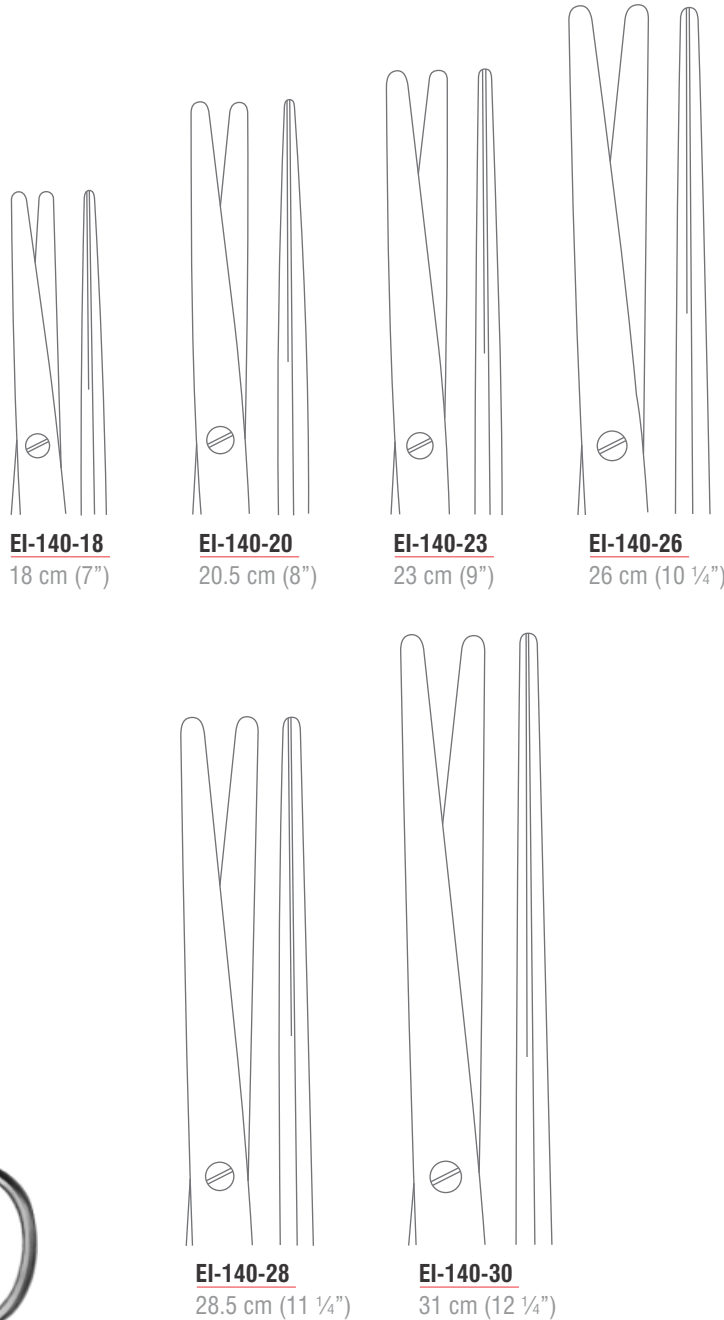

EI-140-18
 18 cm (7")

EI-140-20
 20.5 cm (8")

EI-140-23
 23 cm (9")

EI-140-26
 26 cm (10 1/4")

EI-140-28
 28.5 cm (11 1/4")

EI-140-30
 31 cm (12 1/4")

Dissecting Scissors
Präparierscheren
Tijeras de disección
Ciseaux à dissection
Forbici per dissezione

THORAX, CARDIOVASCULAR SURGERY

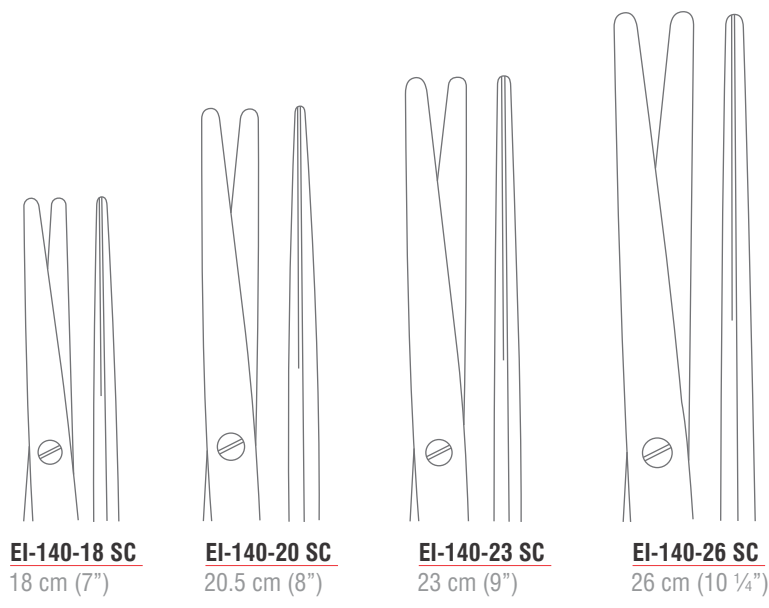

EI-140-18 SC
18 cm (7")

EI-140-20 SC
20.5 cm (8")

EI-140-23 SC
23 cm (9")

EI-140-26 SC
26 cm (10 1/4")

SUPEREdge™

SuperEdge™ Metzenbaum-Nelson Dissecting Scissor
Straight, Blunt/Blunt

Dissecting Scissors
Präparierscheren
Tijeras de disección
Ciseaux à dissection
Forbici per dissezione



Metzenbaum-Nelson Dissecting Scissor
Curved, Blunt/Blunt

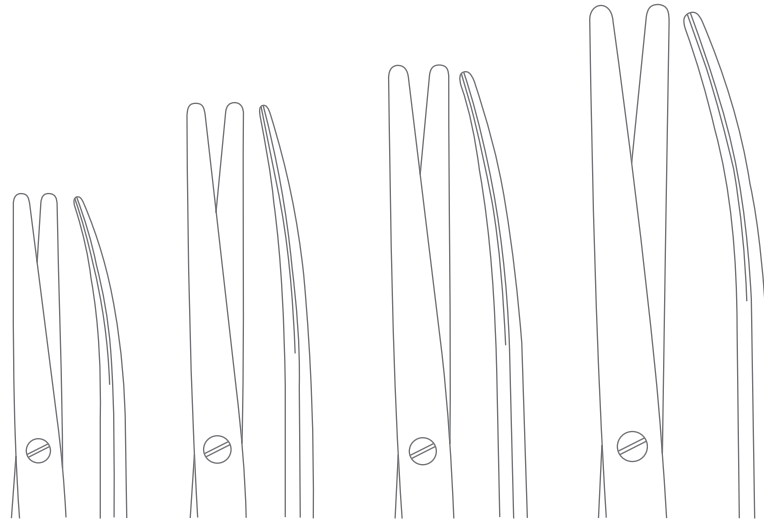

EI-141-18
18 cm (7")

EI-141-20
20.5 cm (8")

EI-141-23
23 cm (9")

EI-141-26
26 cm (10 1/4")



EI-141-28
28.5 cm (11 1/4")

EI-141-30
31 cm (12 1/4")

Dissecting Scissors
Präparierscheren
Tijeras de disección
Ciseaux à dissection
Forbici per dissezione

THORAX, CARDIOVASCULAR SURGERY



EI-141-18 SC
18 cm (7")

EI-141-20 SC
20.5 cm (8")

EI-141-23 SC
23 cm (9")

EI-141-26 SC
26 cm (10 1/4")

SUPEREdge™

SuperEdge™ Metzenbaum-Nelson Dissecting Scissor
Curved, Blunt/Blunt

Dissecting Scissors
Präparierscheren
Tijeras de disección
Ciseaux à dissection
Forbici per dissezione

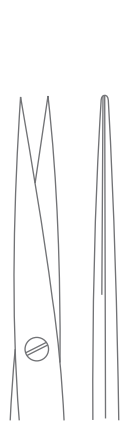

EI-144-18
18 cm (7")



EI-144-20
20.5 cm (8")

Metzenbaum-Nelson Dissecting Scissor
Straight, Sharp/Sharp



EI-145-18
18 cm (7")



EI-145-20
20.5 cm (8")

Metzenbaum-Nelson Dissecting Scissor
Curved, Sharp/Sharp



EI-145-18 SC
Metzenbaum-Nelson Dissecting Scissor
Curved, Sharp/Sharp
Overall Length 18 cm (7")

SUPEREdge™



Dissecting Scissors
 Präparierscheren
 Tijeras de disección
 Ciseaux à dissection
 Forbici per dissezione

THORAX, CARDIOVASCULAR SURGERY



EI-146-14



EI-147-14



EI-148-15
Straight



EI-149-15
Curved

Metzenbaum Dissecting Scissor
 Straight, Sharp/Sharp
 One Serrated Cutting Edge Instead Of Toothed
 Overall Length 14.5 cm (5 3/4")

Metzenbaum Nerve Dissecting Scissor
 Overall Length 15.5 cm (6")

Dissecting Scissors
 Präparierscheren
 Tijeras de disección
 Ciseaux à dissection
 Forbici per dissezione



McIndoe Cartilage Scissor
 Toothed
 Overall Length 18.5 cm (7 1/4")

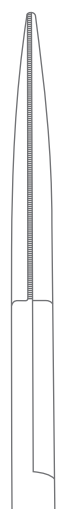

EI-154-18
 Straight

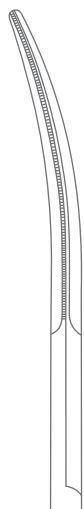

EI-155-18
 Curved



EI-157-18
Martin Cartilage Scissor
 Curved
 Overall Length 18.5 cm (7 1/4")

Face-lift Scissors
Face-lift-Scheren
Tijeras para Face-Lift
Ciseaux pour Face-lift
Forbici per Face-lift



EI-161-18 SC
Kaye Face-Lift Scissor
Curved
Overall Length 18.5 cm (7 1/4")

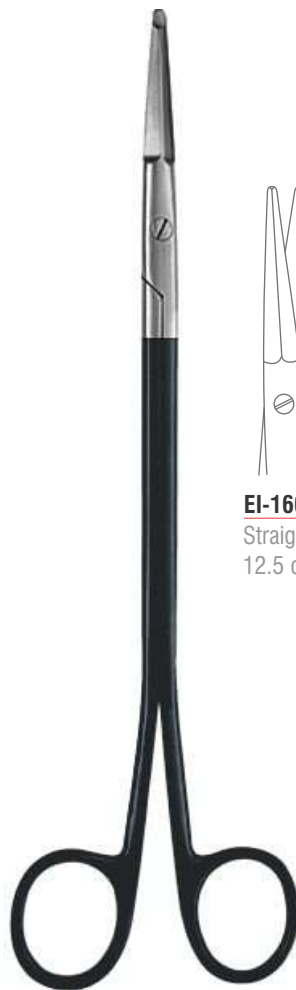

Gorney Face-Lift Scissor

SUPEREdge™

EI-166-12 SC
Straight
12.5 cm (5")

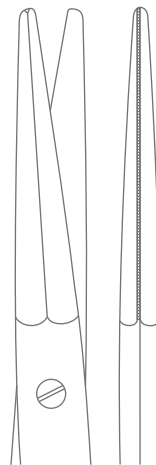

EI-166-19 SC
Straight
19.5 cm (7 3/4")

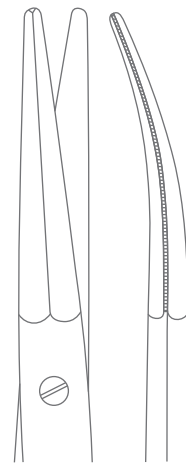

EI-167-19 SC
Curved
19.5 cm (7 3/4")

SUPEREdge™

Face-lift Scissors
 Face-lift-Scheren
 Tijeras para Face-Lift
 Ciseaux pour Face-lift
 Forbici per Face-lift



EI-170-17 SC
Aston Face-Lift Scissor
 Straight
 Overall Length 17 cm (6 3/4")

SUPEREdge™

Dissecting Scissors
 Präparierscheren
 Tijeras de disección
 Ciseaux à dissection
 Forbici per dissezione

THORAX, CARDIOVASCULAR SURGERY

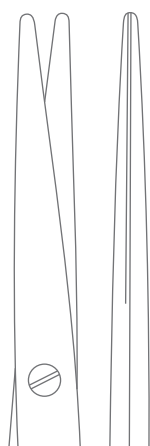

EI-176-16
Straight



EI-1EI-16
Curved

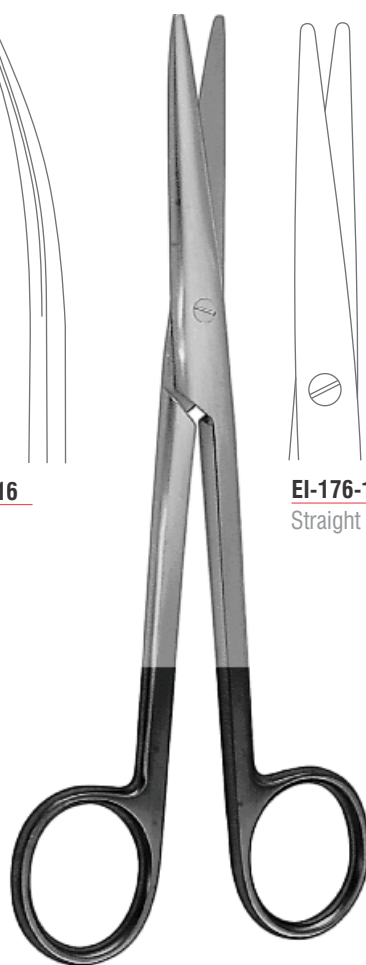

EI-176-16 SC
Straight



EI-1EI-16 SC
Curved

SUPEREdge™

Lexer Dissecting Scissor
Overall Length 16 cm (6 1/4")

SuperEdge™ Lexer Dissecting Scissor
Overall Length 16 cm (6 1/4")

Nasal Scissors
Nasenscheren
Tijeras nasales
Ciseaux nasaux
Forbici nasali



EI-181-10
Curved
Sharp/Sharp



EI-183-10
Curved
Blunt/Blunt

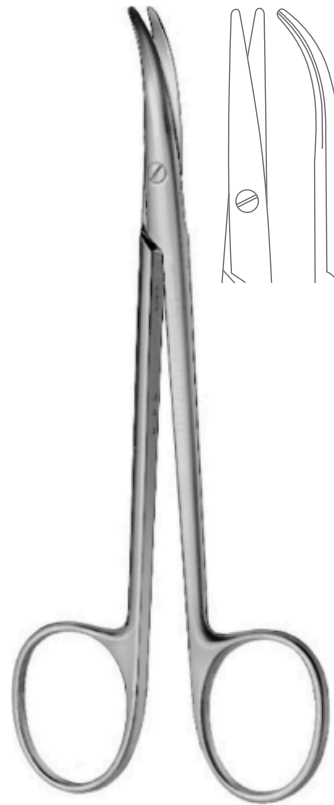

EI-187-11
Cinelli Nasal Scissor
Curved
Overall Length 11.5 cm (4 1/2")

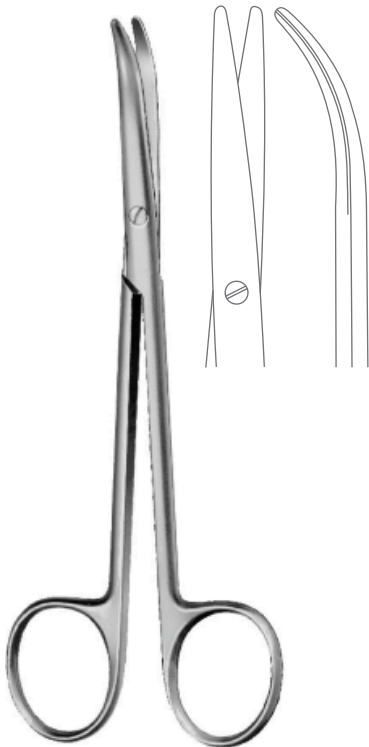

EI-189-14
Fomon Nasal Scissor
Curved
Overall Length 14 cm (5 1/2")

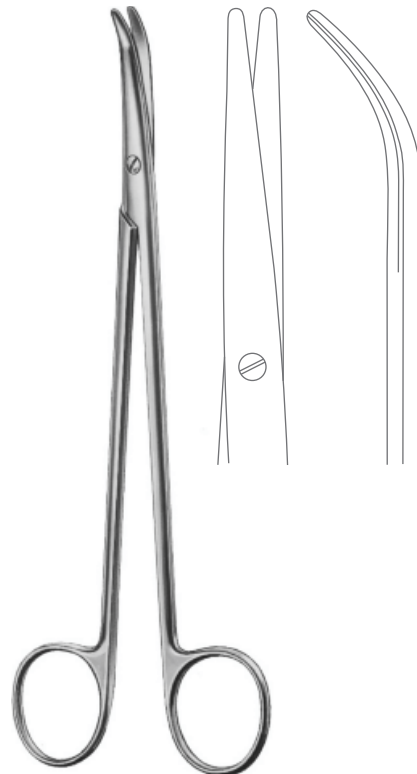
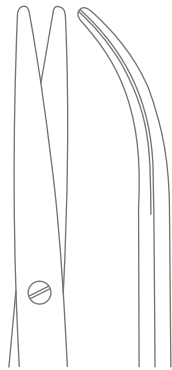

EI-191-19
Thorek Dissecting Scissor
Curved
Overall Length 18.5 cm (7 1/4")

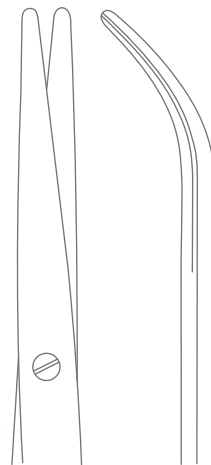

Dissecting Scissors
Präparierscheren
Tijeras de disección
Ciseaux à dissection
Forbici per dissezione

EVA

SCISSORS



EI-194-10
Straight



EI-195-10
Curved

Lexer-Baby Dissecting Scissor
Overall Length 10 cm (4")



EI-196-16
Straight



EI-197-16
Curved

Lexer-Fine Delicate Dissecting Scissor
Slender Pattern
Overall Length 16.5 cm (6 1/2")



EI-200-14
Straight



EI-201-14
Curved

Metzenbaum-Fine Delicate Dissecting Scissor
Blunt/Blunt, Slender Pattern
Overall Length 14.5 cm (5 3/4")

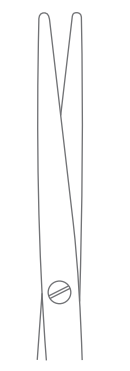

EI-200-14 SC
Straight

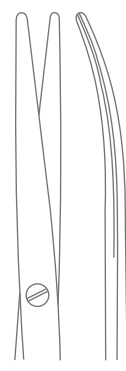

EI-201-14 SC
Curved

SUPEREdge™

SuperEdge™ Metzenbaum-Fine Delicate Dissecting Scissor
Blunt/Blunt, Slender Pattern
Overall Length 14.5 cm (5 3/4")

Dissecting Scissors
Präparierscheren
Tijeras de disección
Ciseaux à dissection
Forbici per dissezione



EI-202-14
Straight



EI-203-14
Curved

Metzenbaum-Fine Delicate Dissecting Scissor
Sharp/Sharp, Slender Pattern
Overall Length 14.5 cm (5 ¾")

Dissecting Scissors
 Präparierscheren
 Tijeras de disección
 Ciseaux à dissection
 Forbici per dissezione

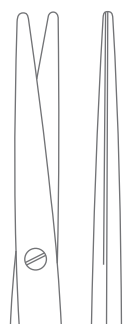
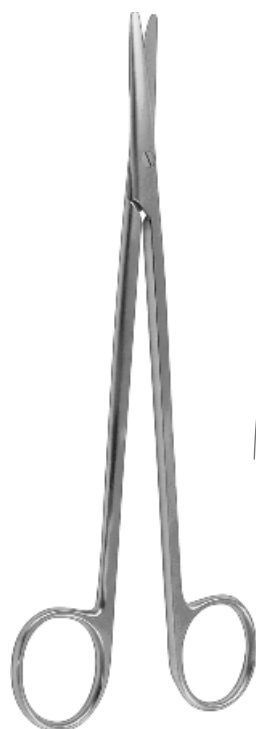

EI-210-18
18 cm (7")



EI-210-20
20 cm (8")

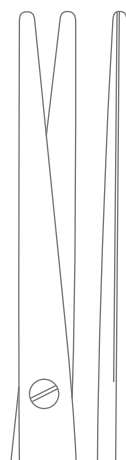

EI-210-23
23 cm (9")

Metzenbaum-Fine Delicate Dissecting Scissor
 Straight, Blunt/Blunt, Slender Pattern

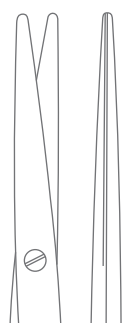
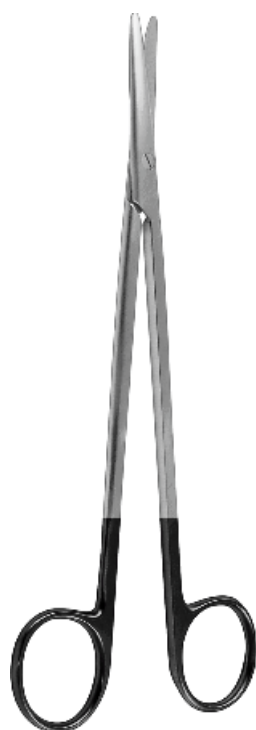

EI-210-18 SC
18 cm (7")

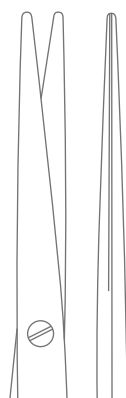

EI-210-20 SC
20 cm (8")

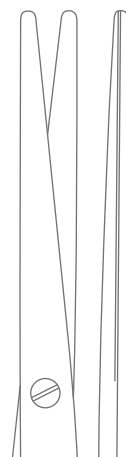

EI-210-23 SC
23 cm (9")

SUPEREdge™

SuperEdge™ Metzenbaum-Fine Delicate Dissecting Scissor
 Straight, Blunt/Blunt, Slender Pattern

Dissecting Scissors
Präparierscheren
Tijeras de disección
Ciseaux à dissection
Forbici per dissezione

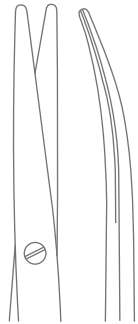

EI-211-18
18 cm (7")



EI-211-20
20 cm (8")



EI-211-23
23 cm (9")

Metzenbaum-Fine Delicate Dissecting Scissor
Straight, Blunt/Blunt, Slender Pattern

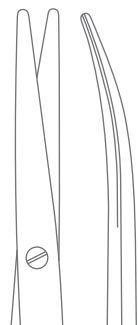
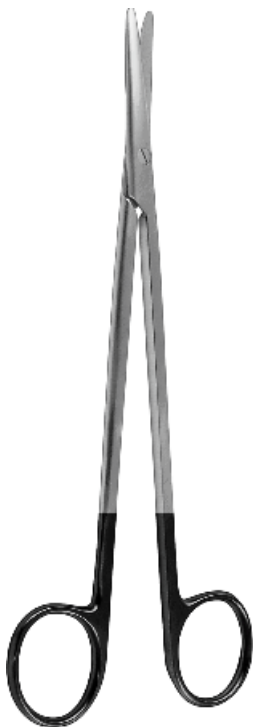

EI-211-18 SC
18 cm (7")

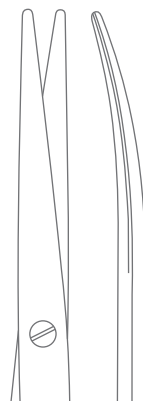

EI-211-20 SC
20 cm (8")



EI-211-23 SC
23 cm (9")

SUPEREdge™

SuperEdge™ Metzenbaum-Fine Delicate Dissecting Scissor
Straight, Blunt/Blunt, Slender Pattern

Dissecting Scissors
Präparierscheren
Tijeras de disección
Ciseaux à dissection
Forbici per dissezione

SCISSORS

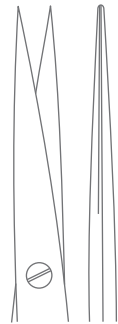

EI-214-18
18 cm (7")



EI-214-20
20 cm (8")

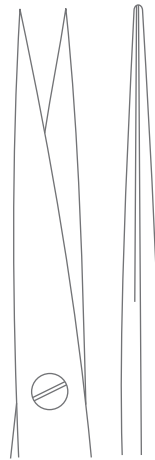

EI-214-23
23 cm (9")

Metzenbaum-Fine Delicate Dissecting Scissor
Straight, Sharp/Sharp, Slender Pattern



EI-214-18 SC
18 cm (7")



EI-214-20 SC
20 cm (8")

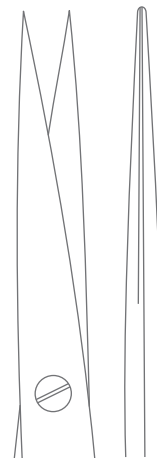

EI-214-23 SC
23 cm (9")

SUPEREdge™

Metzenbaum-Fine Delicate Dissecting Scissor
Straight, Sharp/Sharp, Slender Pattern

Dissecting Scissors
Präparierscheren
Tijeras de disección
Ciseaux à dissection
Forbici per dissezione



EI-215-18
18 cm (7")

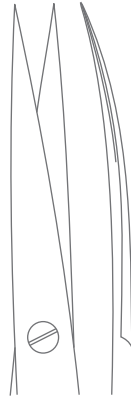

EI-215-20
20 cm (8")



EI-215-23
23 cm (9")

Metzenbaum-Fine Delicate Dissecting Scissor
Straight, Sharp/Sharp, Slender Pattern



EI-215-18 SC
18 cm (7")

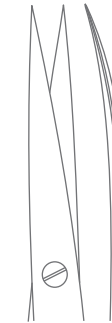

EI-215-20 SC
20 cm (8")

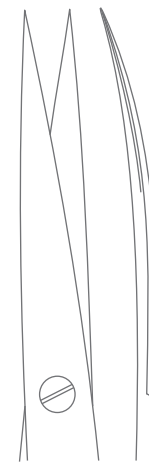

EI-215-23 SC
23 cm (9")

SUPEREdge™

SuperEdge™ Metzenbaum-Fine Delicate Dissecting Scissor
Straight, Sharp/Sharp, Slender Pattern

Dissecting Scissors
Präparierscheren
Tijeras de disección
Ciseaux à dissection
Forbici per dissezione

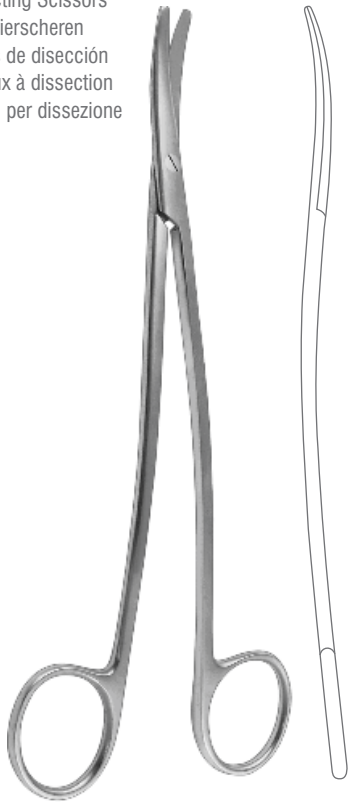

EI-219-18
18 cm (7")



EI-219-20
20 cm (8")

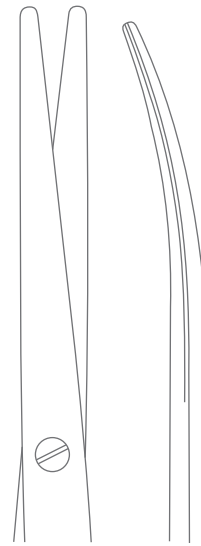

EI-219-23
23 cm (9")

Metzenbaum-Fine Delicate Dissecting Scissor
Curved, S Shaped



EI-223-12
12.5 cm (5")



EI-223-18
18 cm (7")



EI-226-14
Straight



EI-227-14
Curved

Salyer Cleft Palate Dissecting Scissor
Curved, Fine Pattern

Sanvenero Dissecting Scissor
Overall Length 14 cm (5 1/2")

Face-lift Scissors
Face-lift-Scheren
Tijeras para Face-Lift
Ciseaux pour Face-lift
Forbici per Face-lift



EI-230-11
Straight



EI-231-11
Curved

Tenotomy Scissor

Overall Length 11.5 cm (4 1/2")

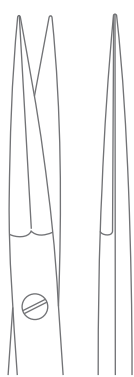

EI-236-14
Straight
Sharp/Sharp



EI-2EI-14
Curved
Sharp/Sharp



EI-238-14
Straight
Blunt/Blunt



EI-239-14
Curved
Blunt/Blunt

Peck-Joseph Face-Lift Scissor

Overall Length 14.5 cm (5 3/4")

Dissecting Scissors
Präparierscheren
Tijeras de disección
Ciseaux à dissection
Forbici per dissezione

EVA

SCISSORS



EI-241-12

Shea Vein Graft Scissor

Curved

Overall Length 12 cm (4 3/4")

Dissecting Scissors
Präparierscheren
Tijeras de disección
Ciseaux à dissection
Forbici per dissezione

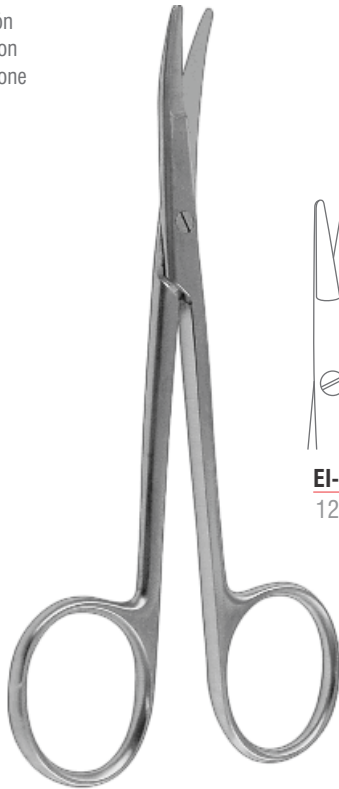

Ragnell (Kilner) Dissecting Scissor
Curved



EI-243-12
12 cm (4 3/4")

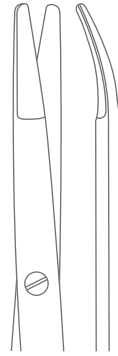

EI-243-15
15 cm (6")

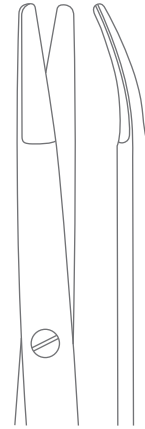

EI-243-18
18 cm (7")



SuperEdge™ Ragnell (Kilner) Dissecting Scissor
Curved



EI-243-12 SC
12 cm (4 3/4")

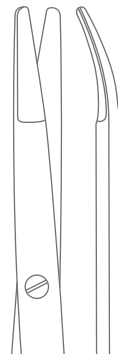

EI-243-15 SC
15 cm (6")

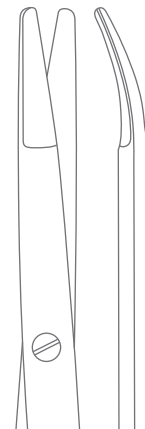

EI-243-18 SC
18 cm (7")

SUPEREdge™

Dissecting Scissors
Präparierscheren
Tijeras de disección
Ciseaux à dissection
Forbici per dissezione

EVA

SCISSORS

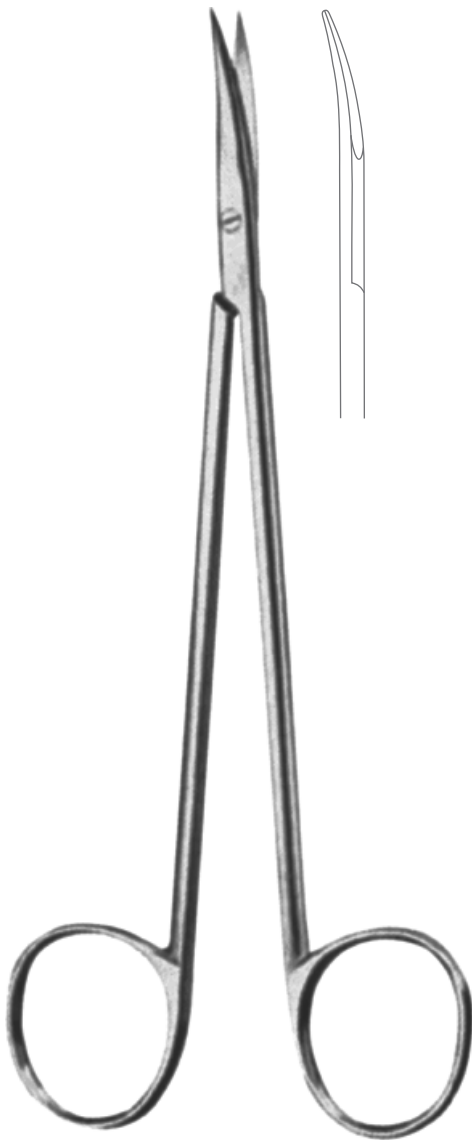

EI-245-15
Nerve Dissecting Scissor
Curved, Semi Sharp
15 cm (6")



EI-248-14
Straight



EI-249-14
Curved

Dissecting Scissor
Overall Length 14.5 cm (5 3/4")

Dissecting Scissors
Präparierscheren
Tijeras de disección
Ciseaux à dissection
Forbici per dissezione



Reynolds Dissecting Scissor

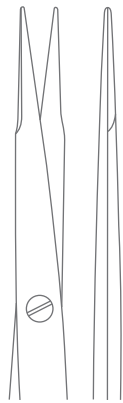

EI-250-15
Straight
15.5 cm (6")

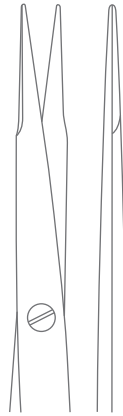

EI-250-18
Straight
18 cm (7")



EI-251-15
Curved
15.5 cm (6")

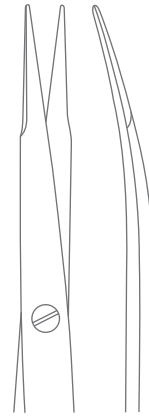

EI-251-18
Curved
18 cm (7")

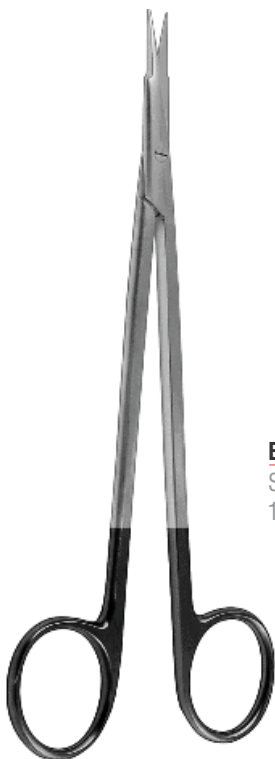

SuperEdge™ Reynolds Dissecting Scissor

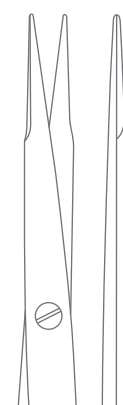

EI-250-15 SC
Straight
15.5 cm (6")



EI-250-18 SC
Straight
18 cm (7")



EI-251-15 SC
Curved
15.5 cm (6")



EI-251-18 SC
Curved
18 cm (7")

SUPEREdge™

Dissecting Scissors
Präparierscheren
Tijeras de disección
Ciseaux à dissection
Forbici per dissezione

EVA

SCISSORS

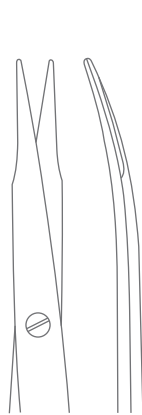

EI-253-13
Curved

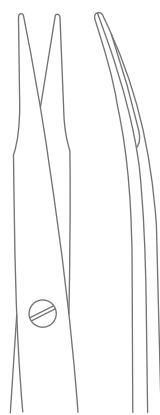

EI-253-15
Curved

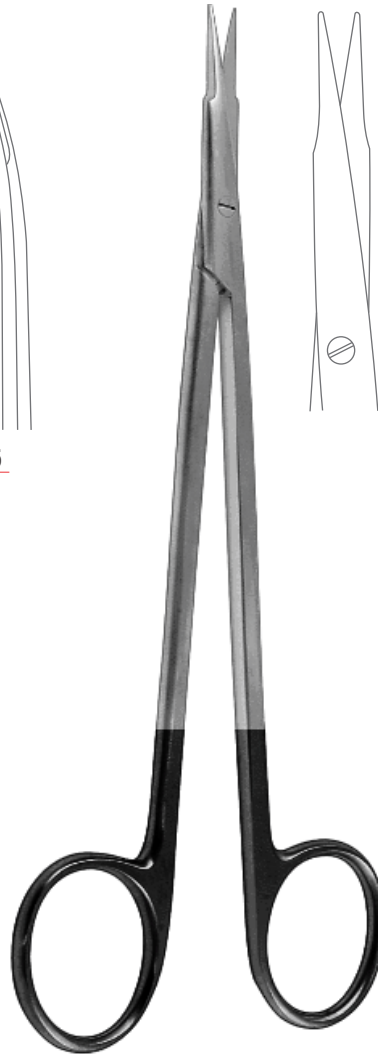

EI-253-15
Jameson Dissecting Scissor
Curved
Overall Length 15.5 cm (6")

EI-253-15 SC
SuperEdge™ Jameson Dissecting Scissor
Curved
Overall Length 15.5 cm (6")

SUPEREdge™

Dissecting Scissors
 Präparierscheren
 Tijeras de disección
 Ciseaux à dissection
 Forbici per dissezione



EI-257-13
Jameson-Werber Dissecting Scissor
 Curved
 Overall Length 13 cm (5")



Potts Dissecting Scissor

EI-259-18
 Curved
 18 cm (7")

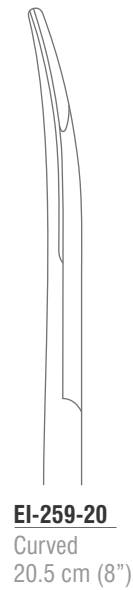

EI-259-20
 Curved
 20.5 cm (8")

Vascular Scissors
Gefäßscheren
Tijeras vasculares
Ciseaux vasculaires
Forbici vascolari

EVA

SCISSORS

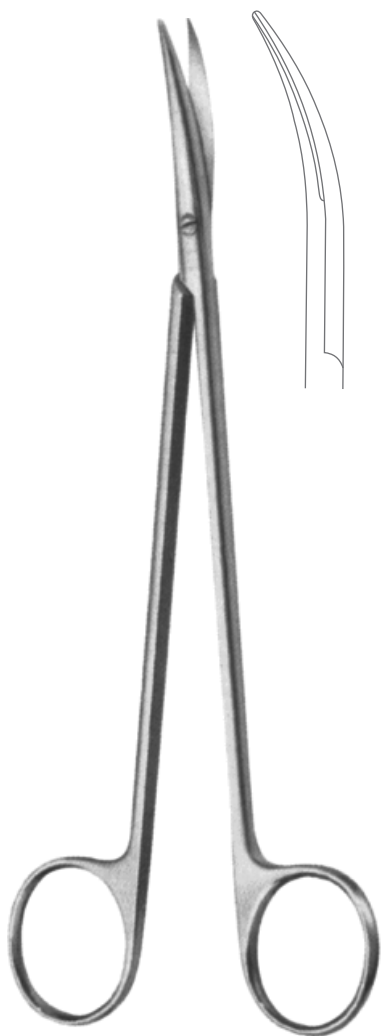

EI-261-17
DeBakey Arteriotomy Scissor
Curved
Overall Length 17.5 cm (7")



Vascular Scissor
Overall Length 19 cm (7 1/2")



EI-264-19
Straight



EI-265-19
Curved

Dissecting Scissors
 Präparierscheren
 Tijeras de disección
 Ciseaux à dissection
 Forbici per dissezione

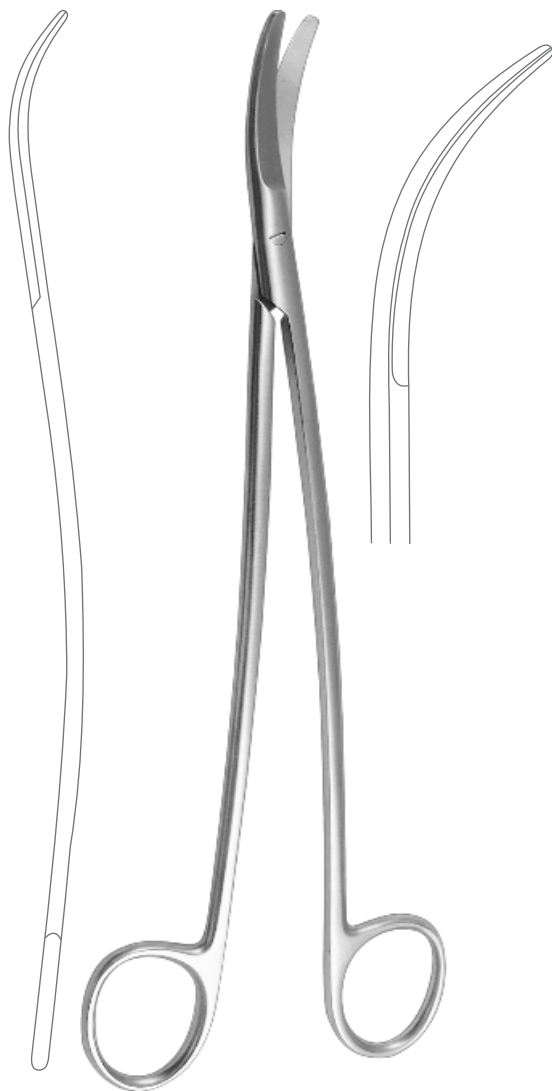

EI-267-24
Satinsky Thoracic Scissor
 Curved
 Overall Length 25.5 cm (10")

EI-267-25
Thomson Valve Scissor
 Strongly Curved, With One Serrated Blade
 Overall Length 25.5 cm (10")

Vascular Scissors
Gefäßscheren
Tijeras vasculares
Ciseaux vasculaires
Forbici vascolari



EI-269-12
Diethrich-Salyer Cleft Palate Dissecting Scissor
Angled
Overall Length 12 cm (4 3/4")



Peripheral Vascular Scissor
Overall Length 12.5 cm (5")



EI-271-25
Angled 25°

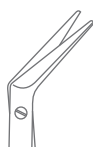

EI-271-45
Angled 45°

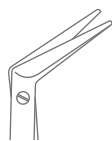

EI-271-60
Angled 60°

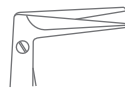

EI-271-90
Angled 90°

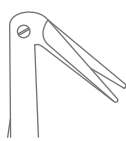

EI-271-00
Angled 125°

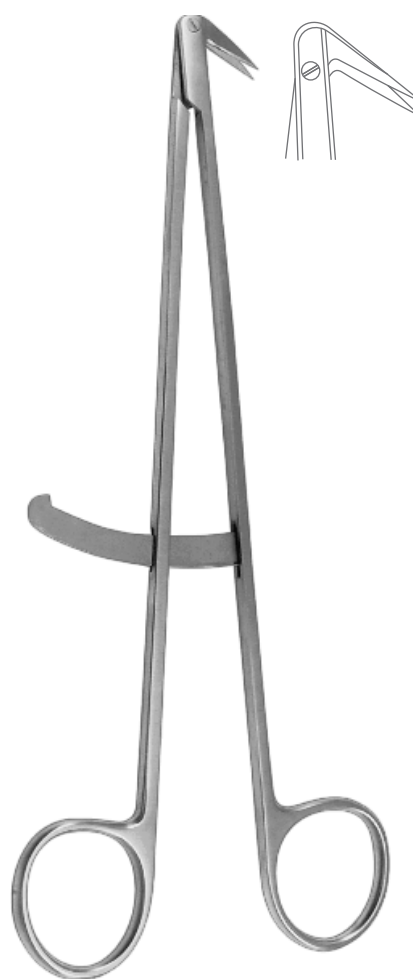

EI-2EI-00
Diethrich Vascular Scissor
Angled, 125° With Guide
Overall Length 17.5 cm (7")

Vascular Scissors
Gefäßscheren
Tijeras vasculares
Ciseaux vasculaires
Forbici vascolari

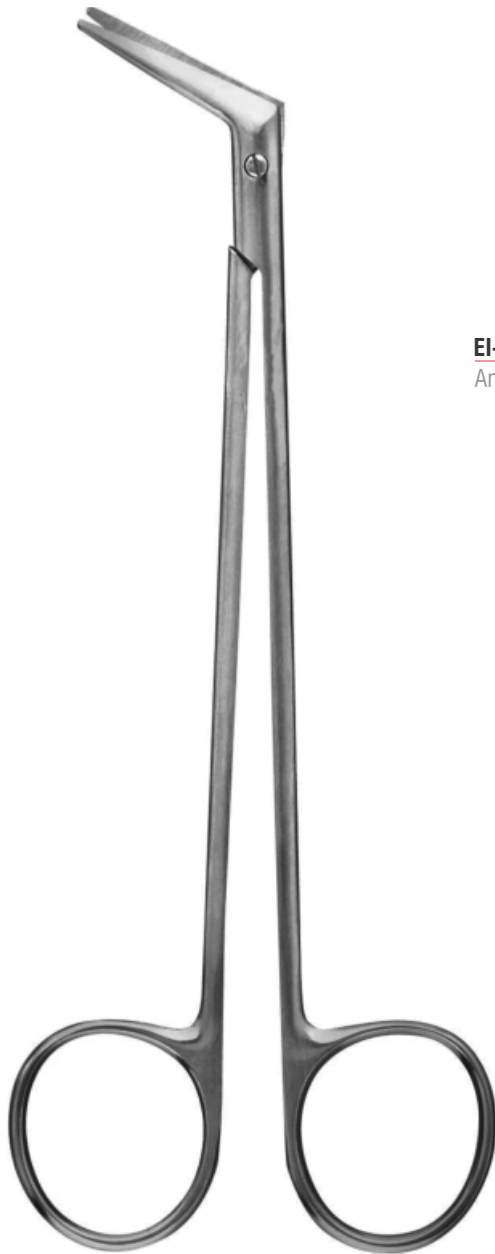

DeBakey Vascular Scissor
Overall Length 16.5 cm (6 1/2")

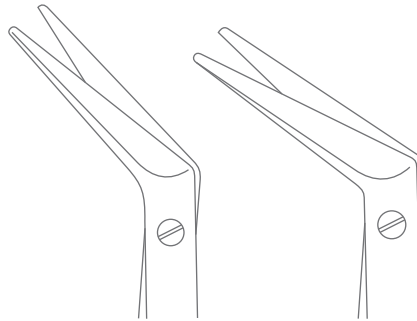

EI-2EI-25
Angled 25°

EI-2EI-45
Angled 45°

EI-2EI-60
Angled 60°

Vascular Scissors
Gefäßscheren
Tijeras vasculares
Ciseaux vasculaires
Forbici vascolari

SCISSORS



EI-279-19
Angled 60°
With One Probe Tip

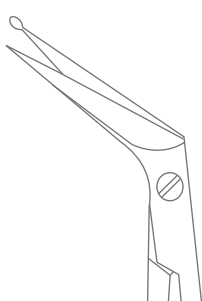

EI-281-25
Angled 25°

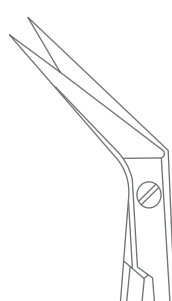

EI-281-45
Angled 45°

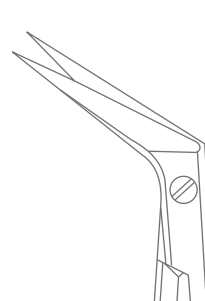

EI-281-60
Angled 60°

Potts-Smith Vascular Scissor
Angled 60° With Probe Tip
Overall Length 18 cm (7")



EI-281-25 SC
Angled 25°

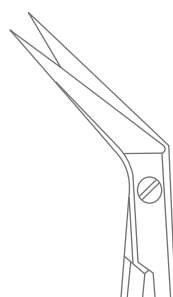

EI-281-45 SC
Angled 45°

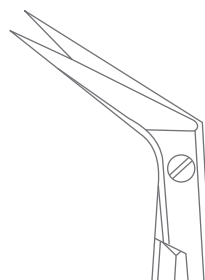

EI-281-60 SC
Angled 60°

SUPEREdge™

SuperEdge™ Potts-Smith Vascular Scissor
Overall Length 18 cm (7")

Vascular Scissors
Gefäßscheren
Tijeras vasculares
Ciseaux vasculaires
Forbici vascolari



Angled on Flat

EI-283-19
Potts-Smith Vascular Scissor
Angled 60°
Overall Length 18.5 cm (7 1/4")

Vascular Scissors
 Gefäßscheren
 Tijeras vasculares
 Ciseaux vasculaires
 Forbici vascolari

EVA

SCISSORS

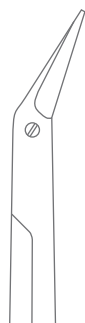

EI-285-25
 Angled 25°
 12 mm

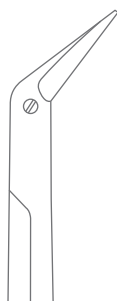

EI-285-45
 Angled 45°
 12 mm

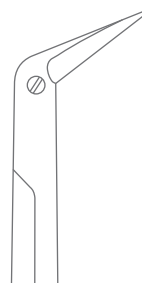

EI-285-60
 Angled 60°
 12 mm

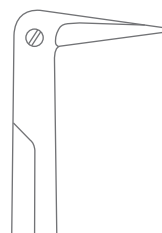

EI-285-90
 Angled 90°
 12 mm

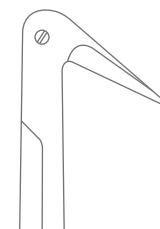

EI-287-00
 Angled 125°
 12 mm

Standard Blade

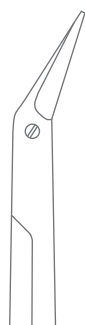

EI-289-25
 Angled 25°
 10 mm

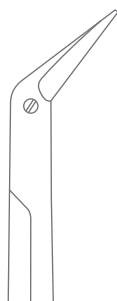

EI-289-45
 Angled 45°
 10 mm

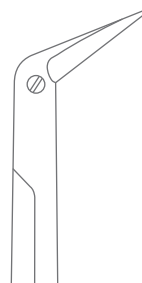

EI-289-60
 Angled 60°
 10 mm

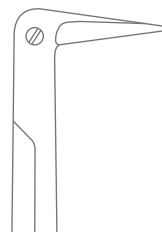

EI-289-90
 Angled 90°
 10 mm

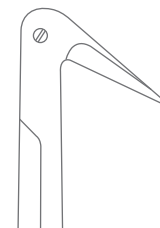

EI-291-00
 Angled 125°
 10 mm

Delicate Blade



EI-293-25
 Angled 25°
 8 mm

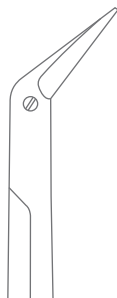

EI-293-45
 Angled 45°
 8 mm

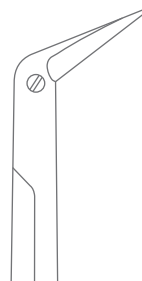

EI-293-60
 Angled 60°
 8 mm

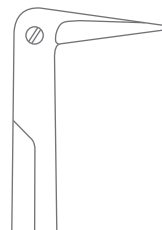

EI-293-90
 Angled 90°
 8 mm

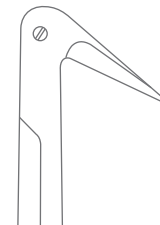

EI-295-00
 Angled 125°
 8 mm

Ultra Delicate Blade



Diethrich-Potts Vascular Scissor
 Overall Length 18 cm (7")

Vascular Scissors
Gefäßscheren
Tijeras vasculares
Ciseaux vasculaires
Forbici vascolari

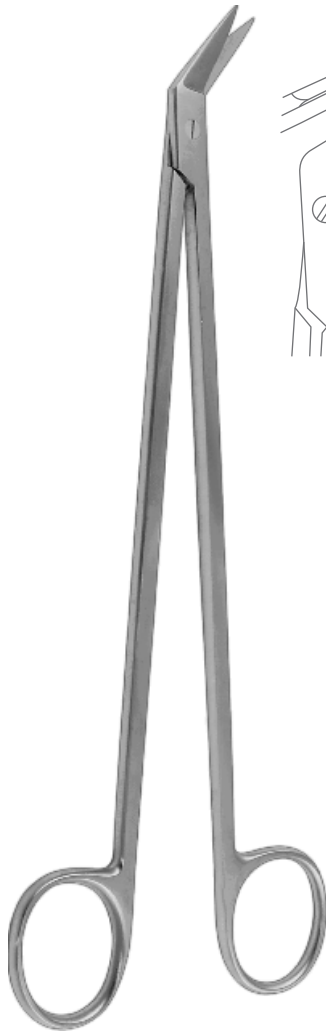

EI-299-22
Potts-De Martel Cardiovascular Scissor
Angled 60°
Overall Length 22 cm (8 3/4")

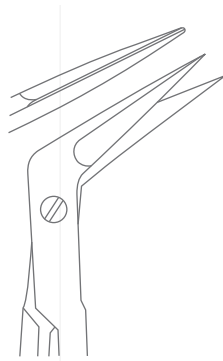

EI-301-16
DeBakey Offset Scissor
S Shaped
Overall Length 15.5 cm (6")

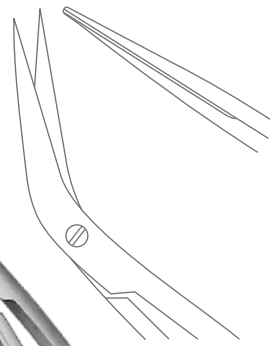

Vascular Scissors
Gefäßscheren
Tijeras vasculares
Ciseaux vasculaires
Forbici vascolari

EVA

SCISSORS

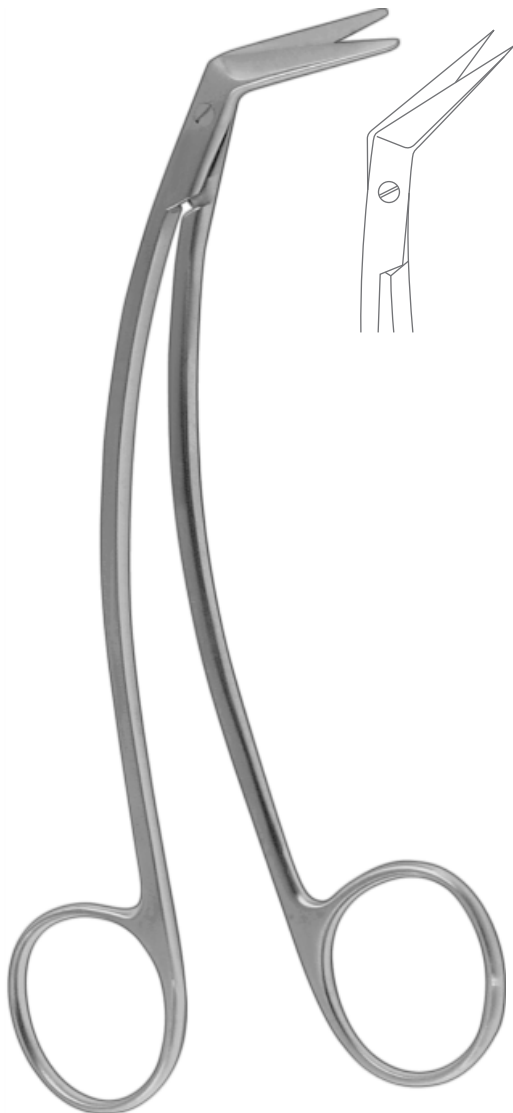

EI-303-15
Favaloro Offset Scissor
Angled
Overall Length 15 cm (6")

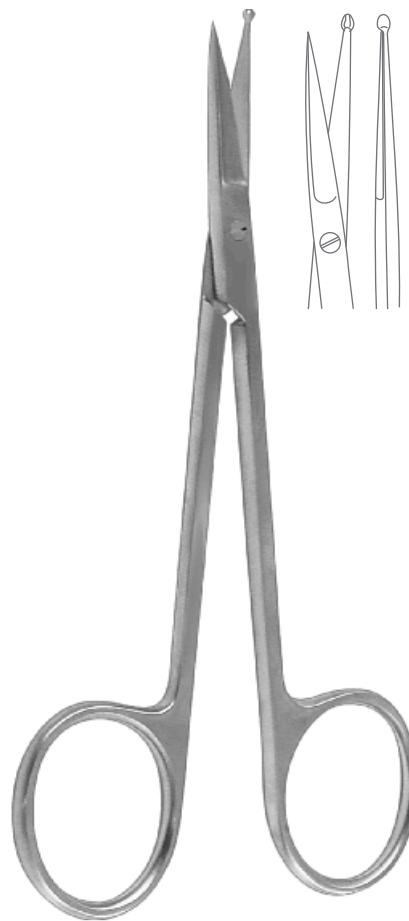

EI-306-12
Vascular Scissor
One Blade Probe
Overall Length 12 cm (4 3/4")

Vascular Scissors
Gefäßscheren
Tijeras vasculares
Ciseaux vasculaires
Forbici vascolari



EI-308-14
Vascular Scissor
One Blade Probe
Overall Length 14.5 cm (5 ¾")

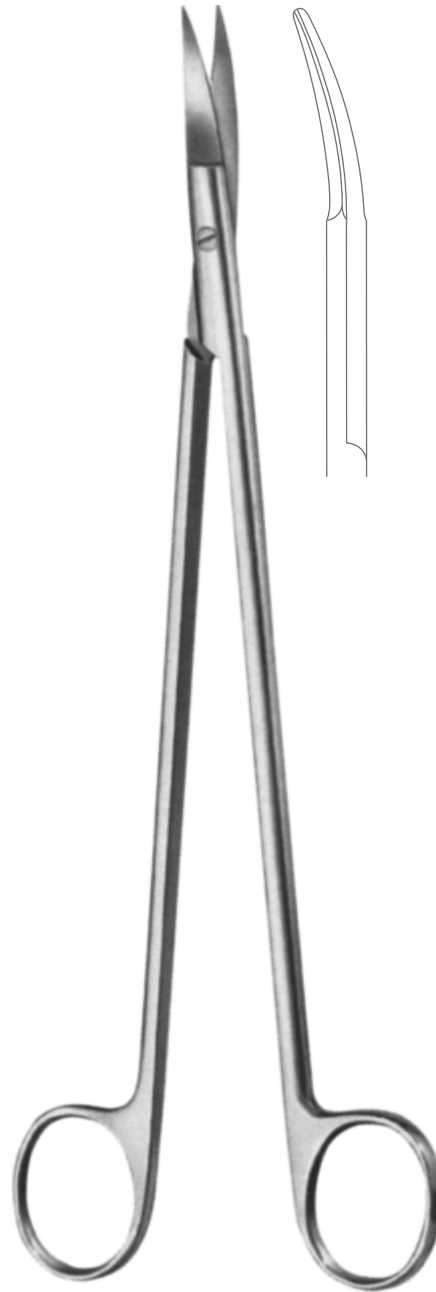

EI-311-22
Strully Vascular Scissor
Curved
Overall Length 22 cm (8 ¾")

Vascular Scissors
Gefäßscheren
Tijeras vasculares
Ciseaux vasculaires
Forbici vascolari

EVA

SCISSORS



EI-312-22
Vascular Scissor
Straight
Overall Length 22.5 cm (8 ¾")

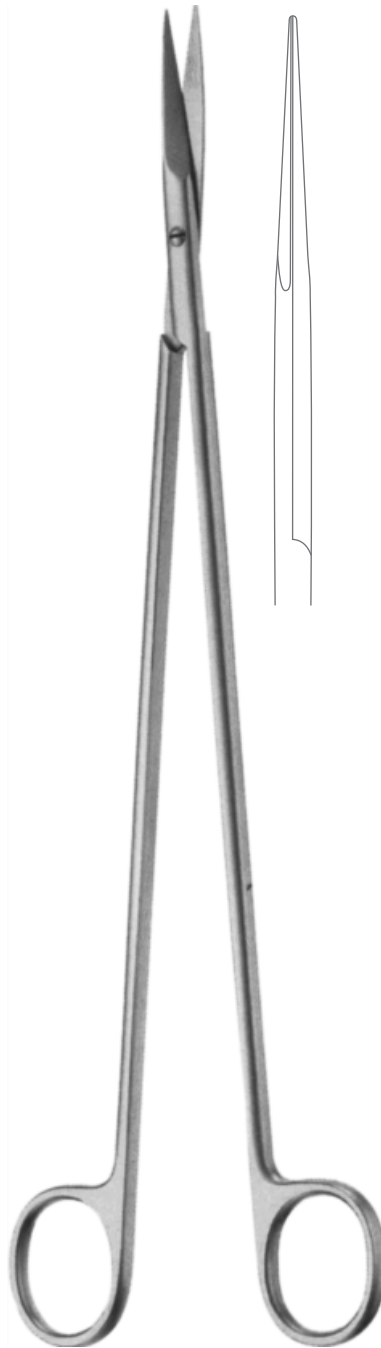

EI-314-28
Barre Vascular Scissor
Straight
Overall Length 28 cm (11")

Vascular Scissors
Gefäßscheren
Tijeras vasculares
Ciseaux vasculaires
Forbici vascolari



EI-315-19
Potts-Smith Vascular Scissor
Curved
Overall Length 19 cm (7 1/2")

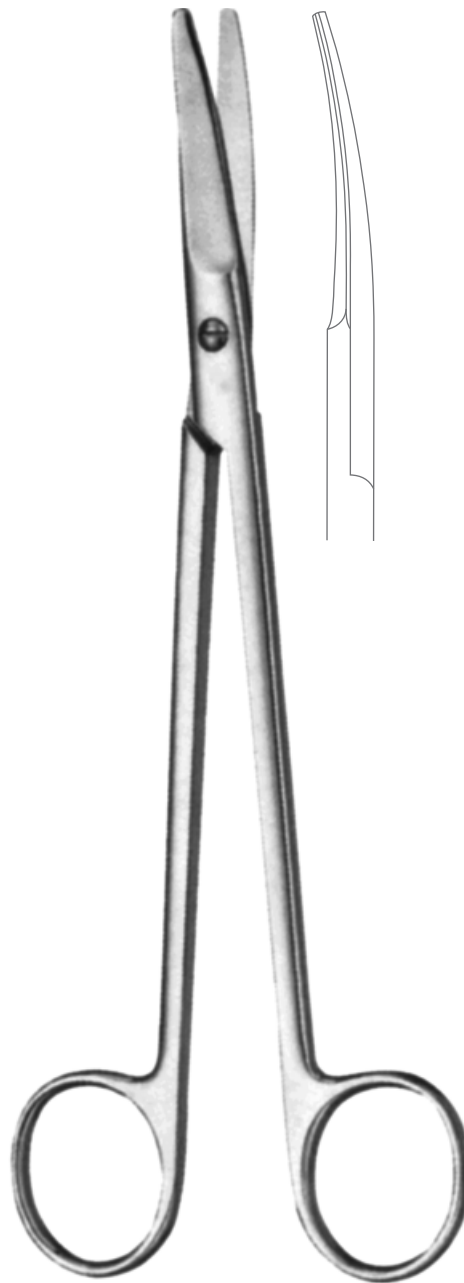

EI-317-19
Cooley Vascular Scissor
Curved
Overall Length 19 cm (7 1/2")

Vascular Scissors
Gefäßscheren
Tijeras vasculares
Ciseaux vasculaires
Forbici vascolari

EVA

SCISSORS

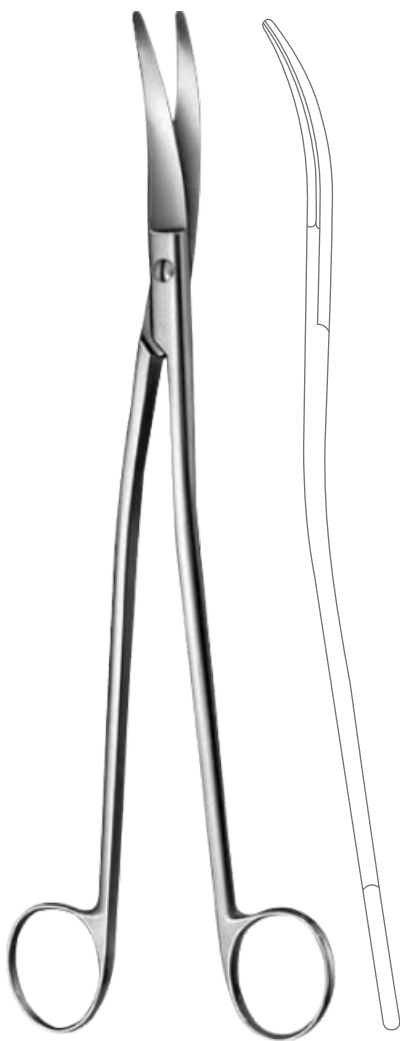

EI-319-23
Klinkenberg-Loth Vascular Scissor
S Shaped
Overall Length 23 cm (9")



EI-323-23
Olivecrona Trigeminal Scissor
Toothed, Length 120 mm
Overall Length 23 cm (9")

Dissecting Scissors
 Präparierscheren
 Tijeras de disección
 Ciseaux à dissection
 Forbici per dissezione

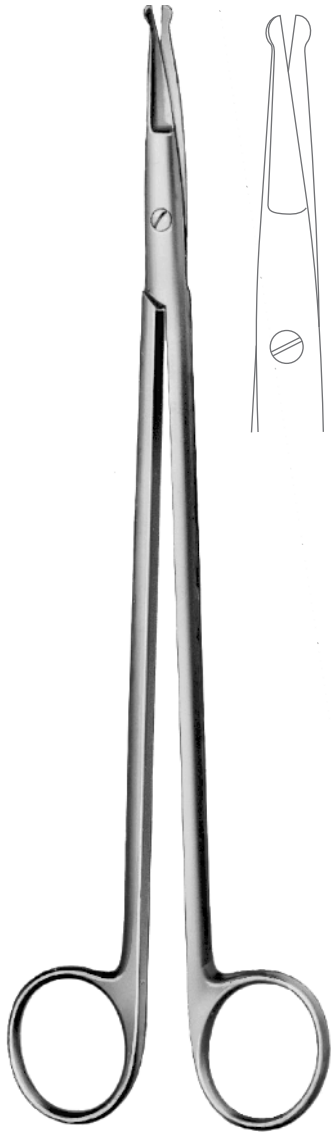

EI-325-23
Stully Neurological Scissor
 Curved
 Overall Length 22.5 cm (8 ¾")

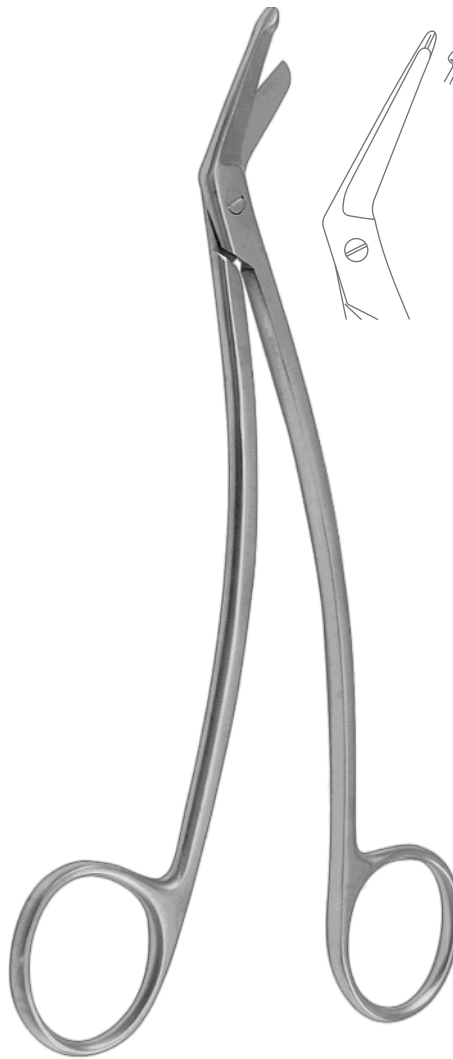

EI-327-17
Schmieden-Taylor Dissecting Scissor
 One Blade Probed
 16.5 cm (6 ½")

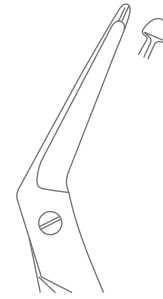

Dissecting Scissors
Präparierscheren
Tijeras de disección
Ciseaux à dissection
Forbici per dissezione

EVA

SCISSORS

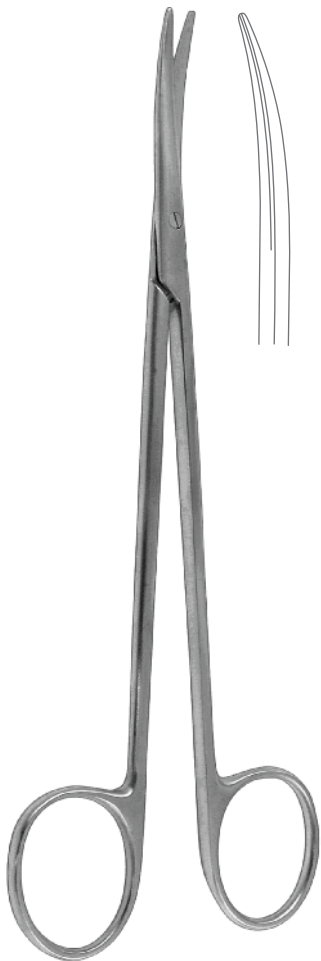

EI-329-17
Toennis-Adson Dissecting Scissor
Curved
Overall Length 17.5 cm (7")

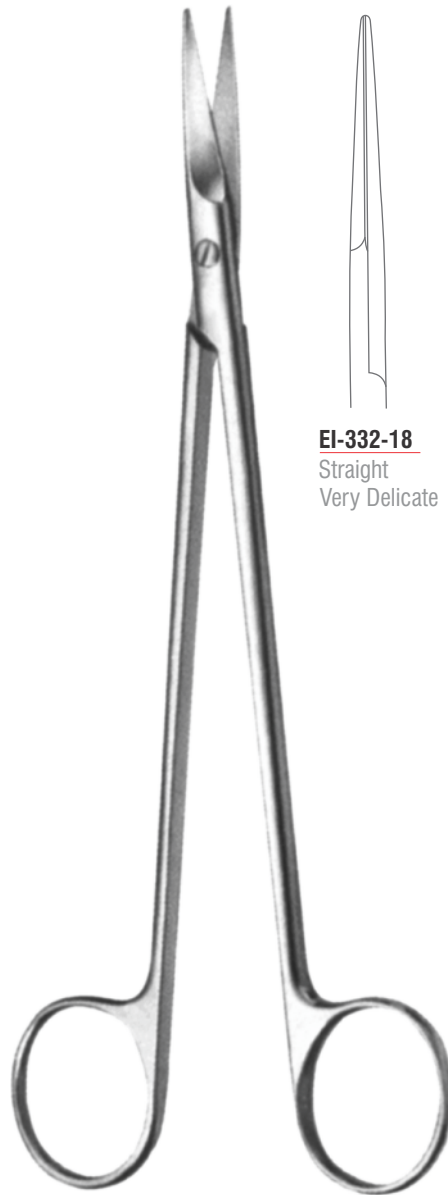

Toennis Dissecting Scissor
Overall Length 18 cm (7")



EI-332-18
Straight
Very Delicate



EI-334-18
Straight
Delicate



EI-335-18
Curved
Delicate

Bone Shear



EI-341-21
Killian Bone Shear
Overall Length 21 cm (8 1/4")



EI-343-21
Muehling Bone Shear
Overall Length 21 cm (8 1/4")

Tonsil Scissors

EVA

SCISSORS



EI-345-20
Caplan Septum Scissor
One Toothed Cutting Edge
Overall Length 20 cm (8")



EI-347-18
Prince Tonsil Scissor
Overall Length 18 cm (7")

Tonsil Scissors



Dean Tonsil Scissor
Angled Upwards
Overall Length 17.5 cm (7")

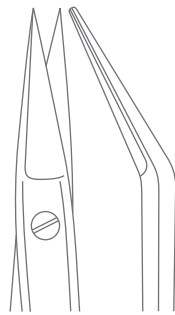

EI-351-17
Angled Upwards

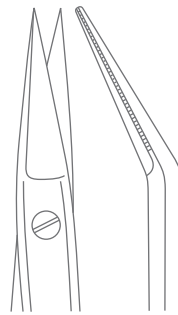

EI-353-17
Toothed
Angled Upwards

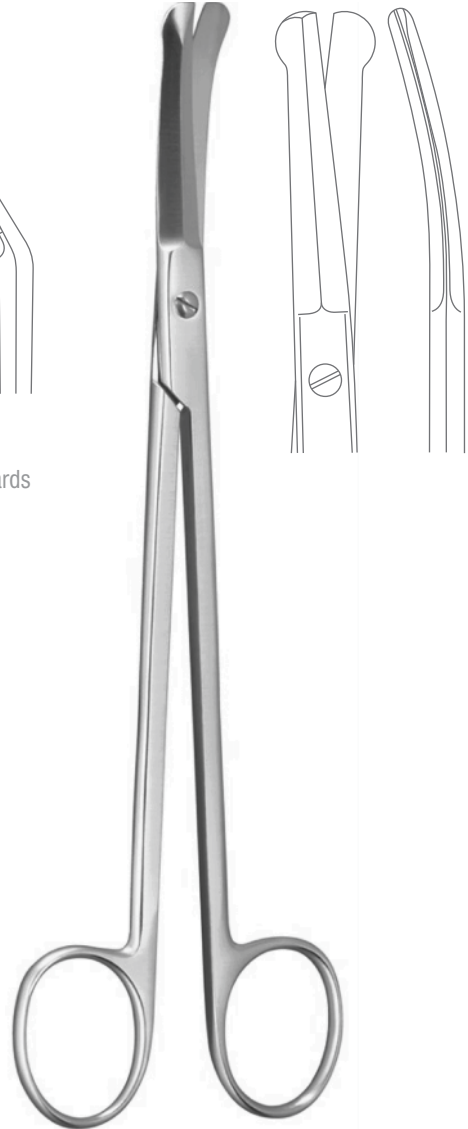

EI-355-19
Good Tonsil Scissor
Overall Length 19.5 cm (7 3/4")

Nasal Scissors
Nasenscheren
Tijeras nasals
Ciseaux nasaux
Forbici nasali

EVA

SCISSORS

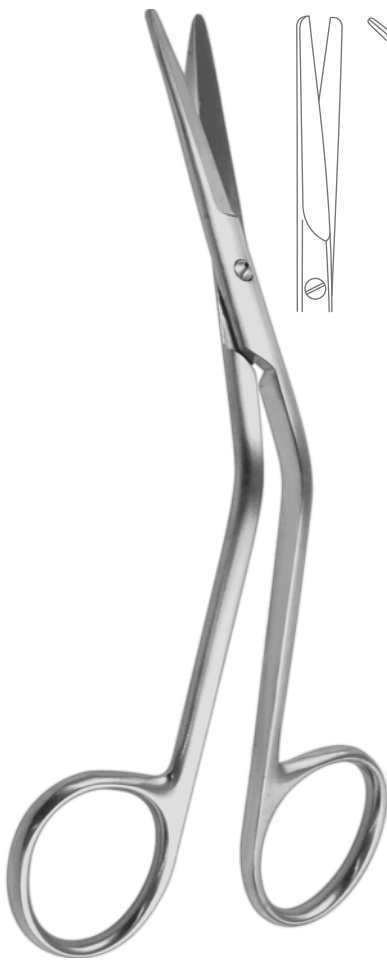

EI-357-15
Fomon Nasal Scissor
Overall Length 15 cm (6")

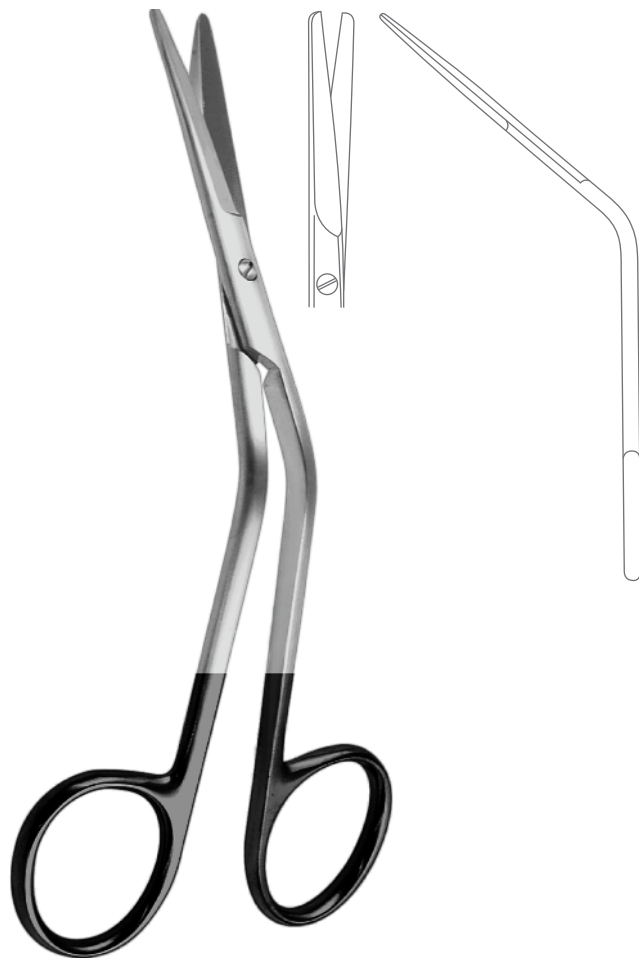

EI-357-15 SC
SuperEdge™ Fomon Nasal Scissor
Overall Length 15 cm (6")

SUPEREdge™

Nasal Scissors
Nasenscheren
Tijeras nasals
Ciseaux nasaux
Forbici nasali

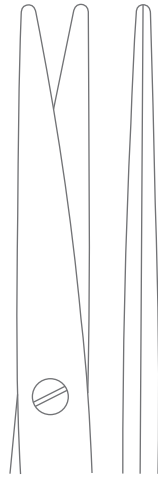

EI-359-16
Cottle Nasal Scissor
Overall Length 16 cm (6 1/4")

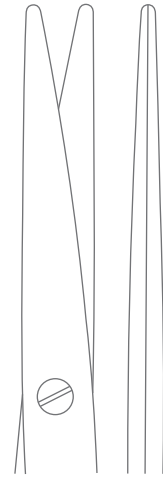

EI-359-16 SC
SuperEdge™ Cottle Nasal Scissor
Overall Length 16 cm (6 1/4")



Nasal Scissors
Nasenscheren
Tijeras nasals
Ciseaux nasaux
Forbici nasali

EVA

SCISSORS



EI-361-18
Heymann Nasal Scissor
Overall Length 18.5 cm (7 ¼")



EI-361-18 SC
SuperEdge™ Heymann Nasal Scissor
Overall Length 18.5 cm (7 ¼")

SUPEREdge™

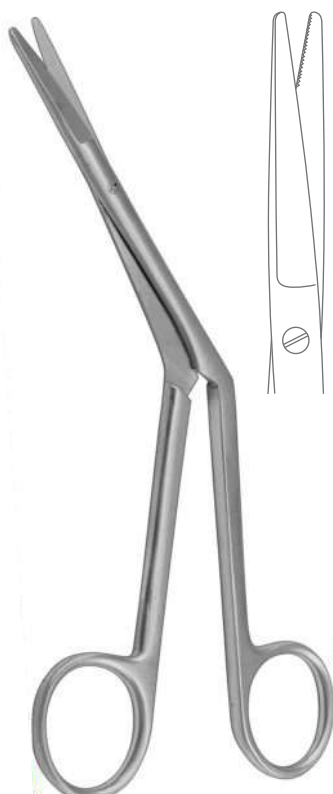

EI-363-18
Heymann Nasal Scissor
One Toothed Cutting Edge
Overall Length 18.5 cm (7 ¼")



EI-363-18
Heymann Nasal Scissor
One Toothed Cutting Edge
Overall Length 18.5 cm (7 ¼")

Nasal Scissors
Nasenscheren
Tijeras nasals
Ciseaux nasaux
Forbici nasali

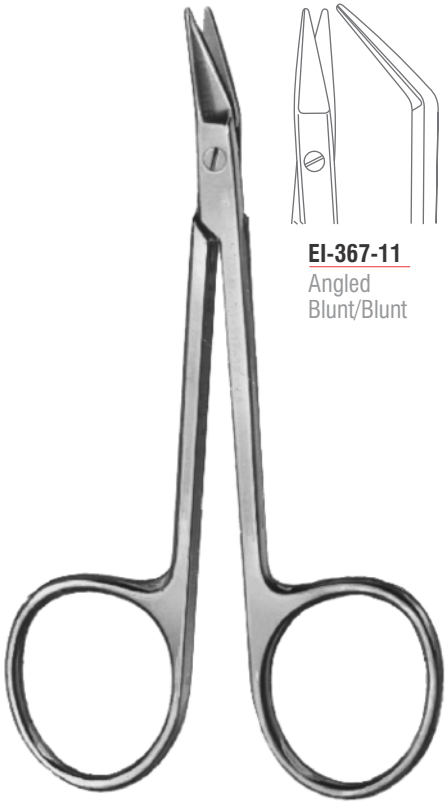

Converse (Graefe) Nasal Scissor
Overall Length 10.5 cm (4 1/4")

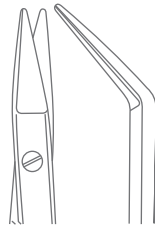

EI-367-11
Angled
Blunt/Blunt

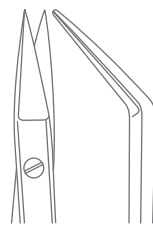

EI-369-11
Angled
Sharp/Sharp



EI-371-14
SuperEdge™ Walter Nasal Scissor
Angled
Overall Length 14 cm (5 1/2")

Episiotomy Scissors
Episiotomiescheren
Tijeras para episiotomía
Ciseaux à épisiotomie
Forbici per episiotomia

EVA

SCISSORS



EI-373-18
Waldmann Nasal Scissor
One Toothed Cutting Edge
Overall Length 18 cm (7")



EI-381-14
Braun-Stadler Episiotomy Scissor
Overall Length 14.5 cm (5 ¾")

Episiotomy Scissors, Umbilical Scissors
 Episiotomiescheren, Nabelschnurscheren
 Tijeras para episiotomía, Tijeras umbilicales
 Ciseaux à épisiotomie, Ciseaux pour le cordon ombilical
 Forbici per episiotomia, Forbici ombelicali

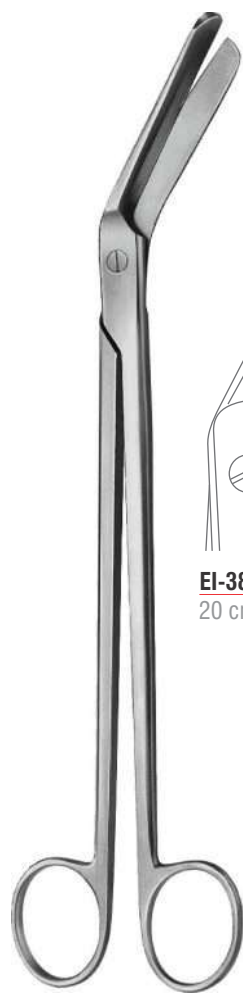

EI-383-20
20 cm (8")

EI-383-20
Braun-Stadler Episiotomy Scissor
20 cm (8")

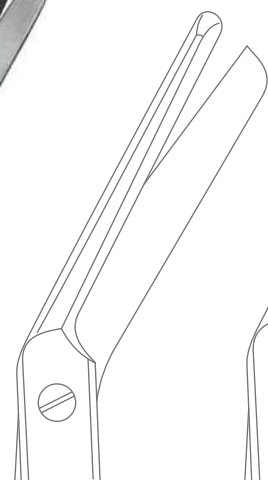

EI-383-22
23 cm (9")

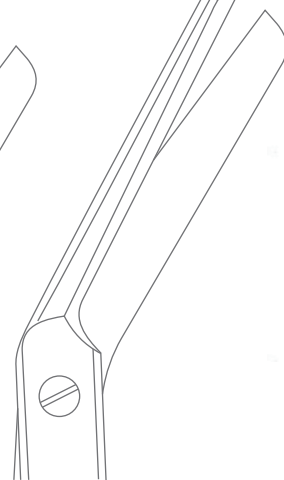

EI-385-10
Braun-Stadler Episiotomy Scissor
Overall Length 10.5 cm (4 1/4")

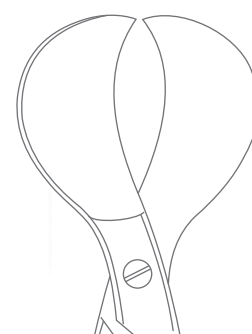

Umbilical Scissors
Nabelschnurscheren
Tijeras umbilicales
Ciseaux pour le cordon ombilical
Forbici ombelicali

EVA

SCISSORS

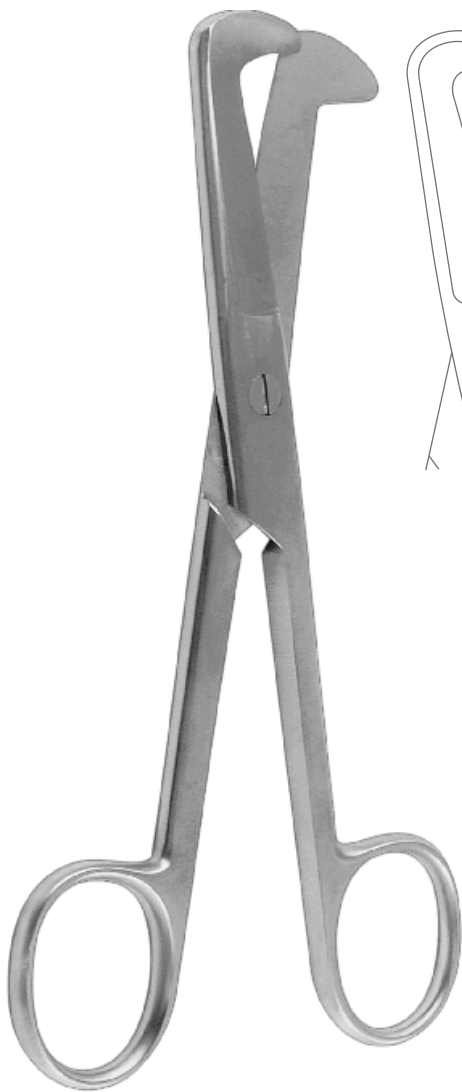

EI-387-16
Schumacher Umbilical Cord Scissor
Overall Length 16 cm (6 1/4")

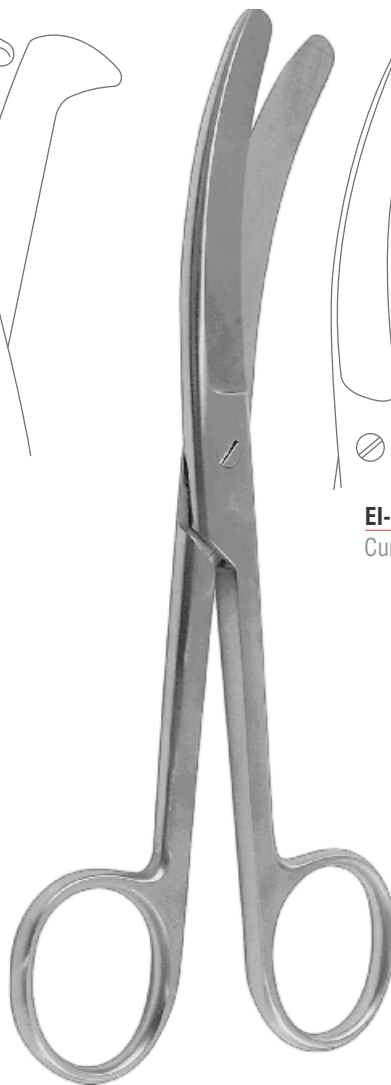
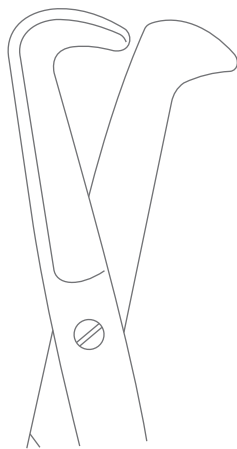

Busch Umbilical Cord Scissor
Overall Length 16 cm (6 1/4")



EI-389-16
Curved

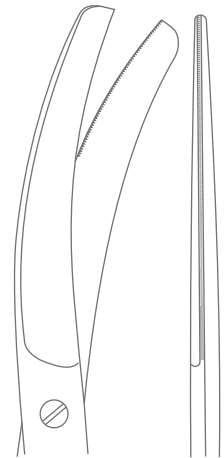

EI-391-16
One Toothed Cutting Edge

Gum Scissors
Zahnfleischscheren
Tijeras para encías
Ciseaux à gencives
Forbici per gengiva



Goldman-Fox Gum Scissor
One Toothed Cutting Edge
Overall Length 13 cm (5")

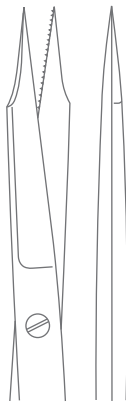

EI-400-13
Straight



EI-400-13
Straight

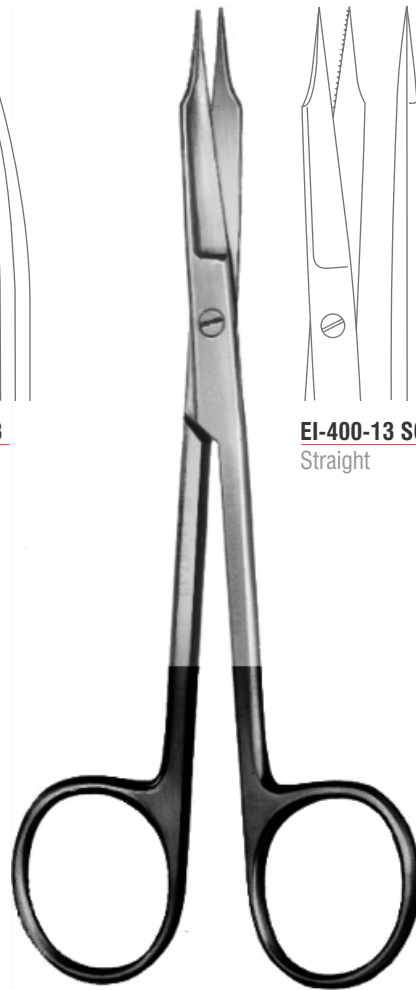

SuperEdge™ Goldman-Fox Gum Scissor
One Toothed Cutting Edge
Overall Length 13 cm (5")

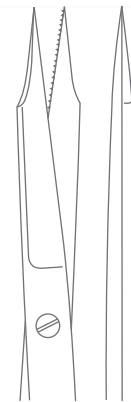

EI-400-13 SC
Straight



EI-400-13 SC
Straight

SUPEREdge™

Operating Scissors
Chirurgische Scheren
Tijeras quirúrgicas
Ciseaux chirurgicaux
Forbici per chirurgia

EVA

SCISSORS



EI-402-12
Straight



EI-403-12
Curved

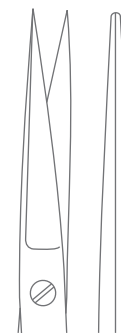

EI-402-12 SC
Straight



EI-403-12 SC
Curved

SUPEREdge™

Wagner Operating Scissor
Overall Length 12 cm (4 ¾")

SuperEdge™ Wagner Operating Scissor
Overall Length 12 cm (4 ¾")

Operating Scissors
Chirurgische Scheren
Tijeras quirúrgicas
Ciseaux chirurgicaux
Forbici per chirurgia



Small Model Operating Scissor
Sharp/Blunt
Overall Length 12 cm (4 ¾")

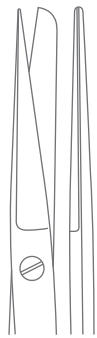

EI-406-12
Straight



EI-407-12
Curved



EI-408-12
Straight



EI-409-12
Curved

Gum Scissors
Zahnfleischscheren
Tijeras para encías
Ciseaux à gencives
Forbici per gengiva

EVA

SCISSORS

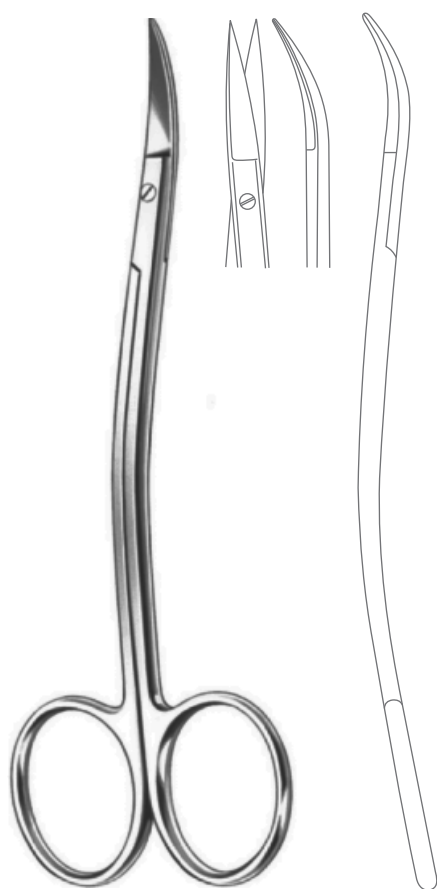

EI-411-11
La Grange Gum Scissor
S Shaped
Overall Length 11.5 cm (4 1/2")



EI-414-11
Straight

EI-415-11
Curved

Delicate Gum Scissor
Overall length 11.5 cm (4 1/2")

Gum Scissors
Zahnfleischscheren
Tijeras para encías
Ciseaux à gencives
Forbici per gengiva



EI-417-16
Locklin Gum Scissor
Angled, One Toothed Cutting Edge
Overall Length 16 cm (6 ¼")

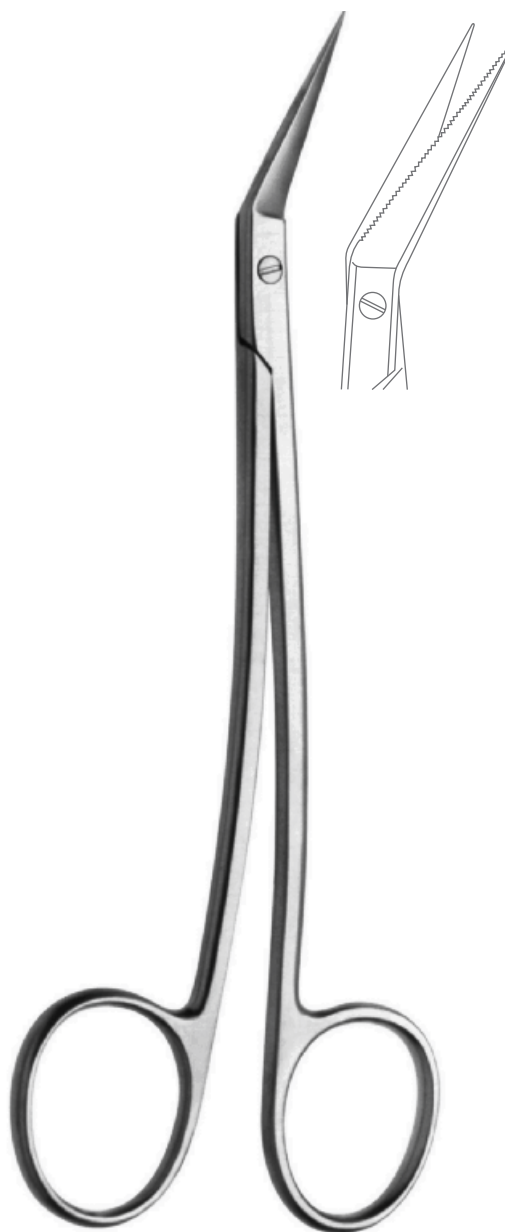

EI-419-16
Locklin Gum Scissor
Angled, S Shaped
One Toothed Cutting Edge
Overall Length 16 cm (6 ¼")

Operating Scissors, Iris Scissors
 Chirurgische Scheren, Irisscheren
 Tijeras quirúrgicas, Tijeras para iridectomía
 Ciseaux chirurgicaux, Ciseaux à iridectomie
 Forbici per chirurgia, Forbici per iridectomia

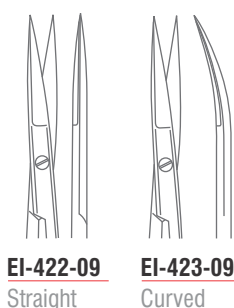

EI-422-09
Straight

EI-423-09
Curved

Very Delicate Operating Scissor

Overall Length 9 cm (3 1/2")

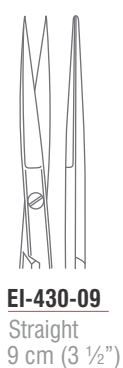

EI-430-09
Straight
9 cm (3 1/2")

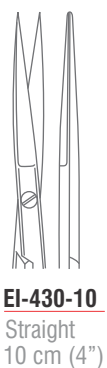

EI-430-10
Straight
10 cm (4")

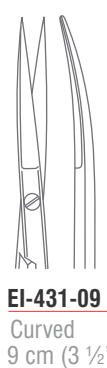

EI-431-09
Curved
9 cm (3 1/2")

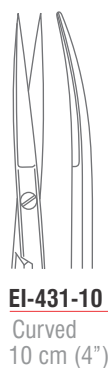

EI-431-10
Curved
10 cm (4")

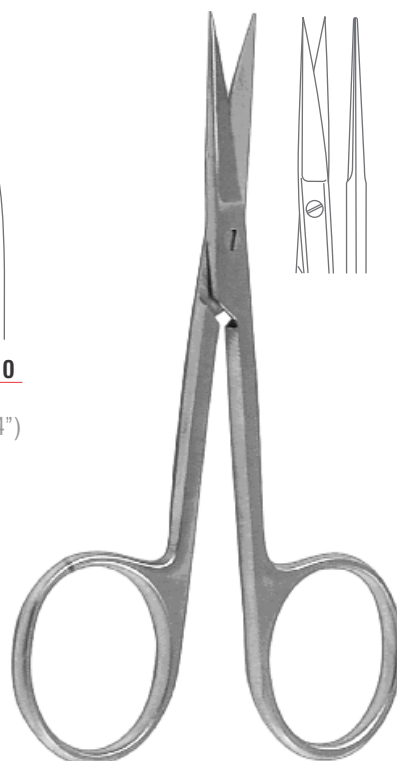

EI-432-10
Iris Scissor
With Extra Flat Blades
Overall Length 10 cm (4")

Iris Scissors
Irisscheren
Tijeras para iridectomía
Ciseaux à iridectomie
Forbici per iridectomia



Bonn Iris Scissor
Overall Length 9 cm (3 1/2")



EI-434-09
Straight



EI-435-09
Curved



EI-436-12
Delicate Dissecting Scissor
Straight, With One Ball Tip
Overall Length 12 cm (4 3/4")



Iris Scissor
Overall Length 11.5 cm (4 1/2")



EI-440-11
Straight



EI-441-11
Curved



SuperEdge™ Iris Scissor
Overall Length 11.5 cm (4 1/2")



EI-440-11 SC
Straight



EI-441-11 SC
Curved

SUPEREdge™

Iris Scissors
Irisscheren
Tijeras para iridectomía
Ciseaux à iridectomie
Forbici per iridectomia

EVA

SCISSORS

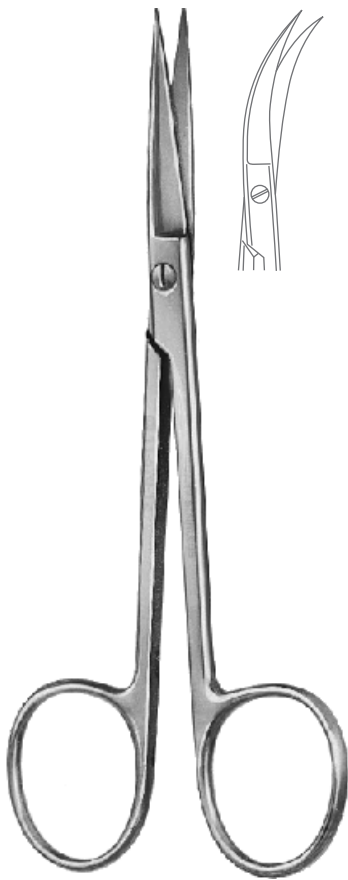

EI-443-11
Iris Scissor
Curved to Side
Overall Length 11.5 cm (4 ½")

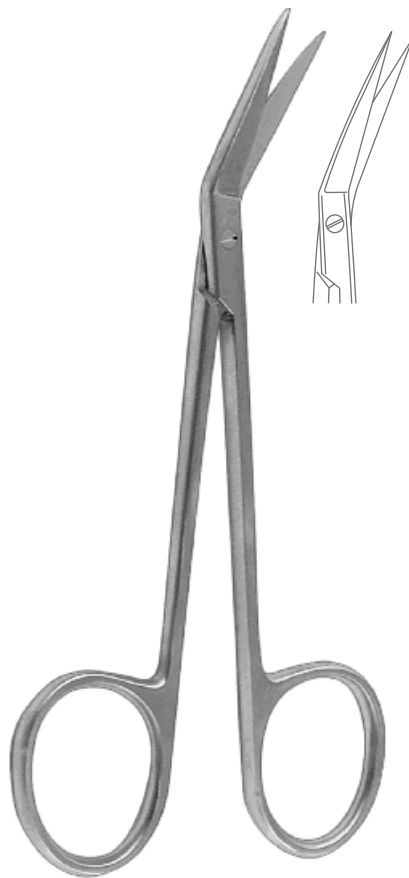

EI-445-11
Iris Scissor
Angled
Overall Length 11.5 cm (4 ½")

Iris Scissors
 Irisscheren
 Tijeras para iridectomía
 Ciseaux à iridectomie
 Forbici per iridectomia



EI-446-12
Straight

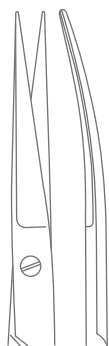

EI-447-12
Curved



EI-446-12 SC
Straight



EI-447-12 SC
Curved

SUPEREdge™

Iris Scissor
Overall Length 12.5 cm (5")

SuperEdge™ Iris Scissor
Overall Length 12.5 cm (5")

Tendon Scissors
Sehnenscheren
Tijeras para tendones
Ciseaux à ténotomie
Forbici per tenotomia



Stevens Tenotomy Scissor
Sharp/Sharp



EI-450-10
Straight
10 cm (4")



EI-450-11
Straight
11 cm (4 1/2")



EI-451-10
Curved
10 cm (4")



EI-451-11
Curved
11 cm (4 1/2")



SuperEdge™ Stevens Tenotomy Scissor
Sharp/Sharp



EI-450-10 SC
Straight
10 cm (4")



EI-450-11 SC
Straight
11 cm (4 1/2")



EI-451-10 SC
Curved
10 cm (4")



EI-451-11 SC
Curved
11 cm (4 1/2")

SUPEREdge™

Tendon Scissors
Sehnscheren
Tijeras para tendones
Ciseaux à ténatomie
Forbici per tenotomia

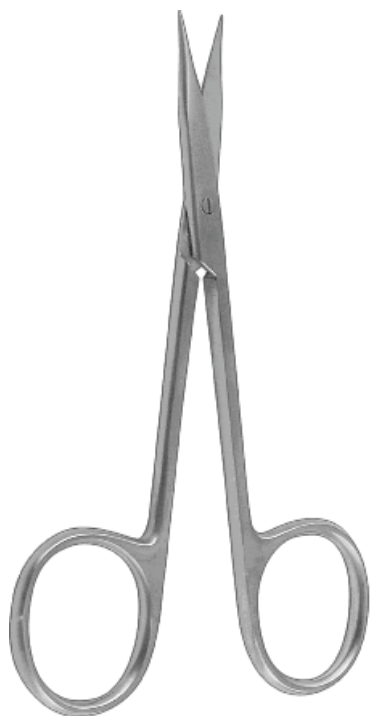

Stevens Tenotomy Scissor
Blunt/Blunt



EI-452-10
Straight
10 cm (4")

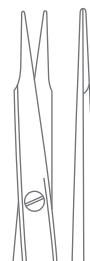

EI-452-11
Straight
11 cm (4 1/2")



EI-452-12
Straight
12.5 cm (5")



EI-453-10
Curved
10 cm (4")



EI-453-11
Curved
11 cm (4 1/2")



EI-453-12
Curved
12.5 cm (5")



SuperEdge™ Stevens Tenotomy Scissor
Blunt/Blunt
Overall Length 11 cm (4 1/2")



EI-452-11 SC
Straight



EI-453-11 SC
Curved

SUPEREdge™

Strabismus Scissors
Strabismusscheren
Tijeras para estrabismo
Ciseaux à strabisme
Forbici per strabismo

EVA

SCISSORS



Strabismus Scissor
Overall Length 11.5 cm (4 1/2")

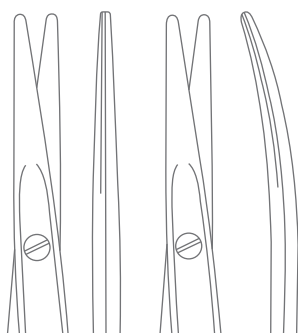

EI-456-11
Straight

EI-457-11
Curved



SuperEdge™ Strabismus Scissor
Overall Length 11.5 cm (4 1/2")

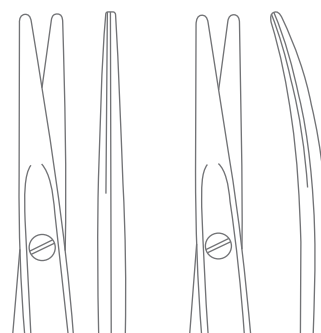

EI-456-11 SC
Straight

EI-457-11 SC
Curved

SUPEREdge™

Dissecting Scissors
Präparierscheren
Tijeras de disección
Ciseaux à dissection
Forbici per dissezione



EI-459-11
Werbs DCR Scissor
Angled Shaft
Overall Length 11.5 cm (4 1/2")

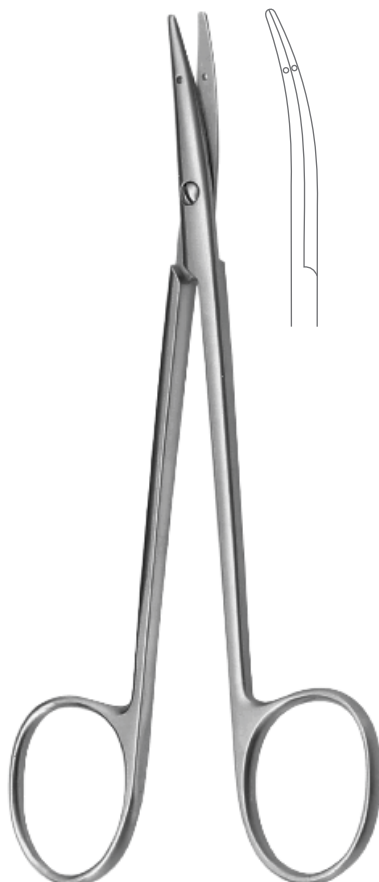

EI-461-11
Littler Dissecting Scissor
Curved, Tip With Eye For Suture
Overall Length 11.5 cm (4 1/2")

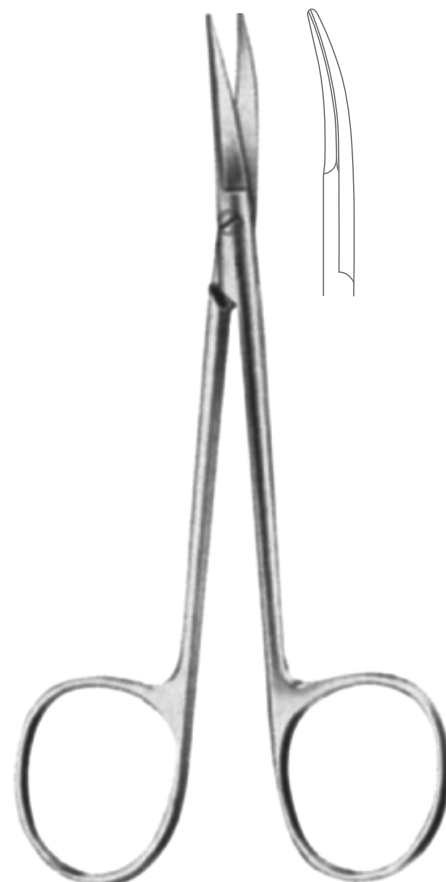

EI-463-11
Cottle Bulldog Scissor
Curved
Overall Length 11.5 cm (4 1/2")

Dissecting Scissors
Präparierscheren
Tijeras de disección
Ciseaux à dissection
Forbici per dissezione

EVA

SCISSORS



EI-466-11
Straight



EI-467-11
Curved

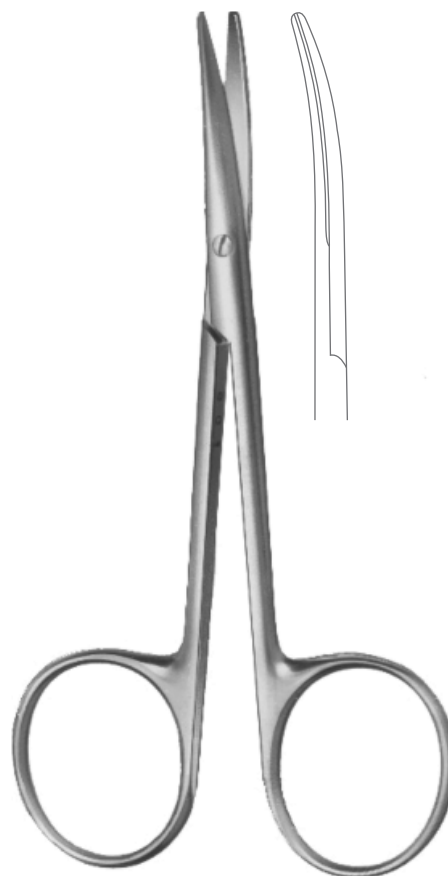

Kilner Delicate Dissecting Scissor
Overall Length 11.5 cm (4 1/2")

EI-469-11
Enuleation Scissor
Curved
Overall Length 11.5 cm (4 1/2")

Dissecting Scissors
 Präparierscheren
 Tijeras de disección
 Ciseaux à dissection
 Forbici per dissezione

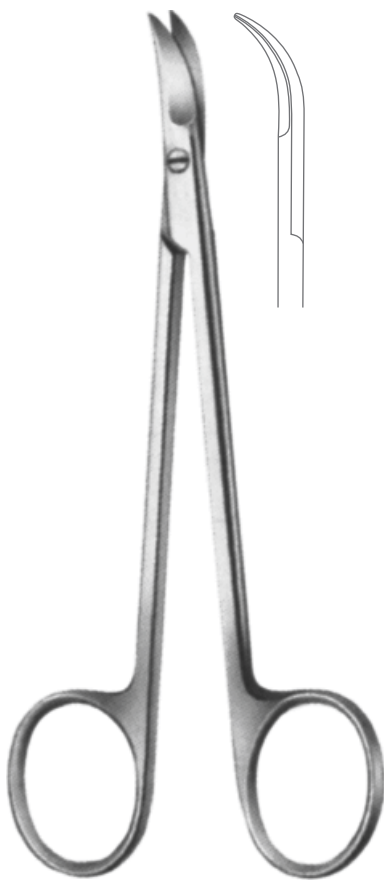

EI-471-11
Chadwick Delicate Scissor
 Curved
 Overall Length 11.5 cm (4 ½")

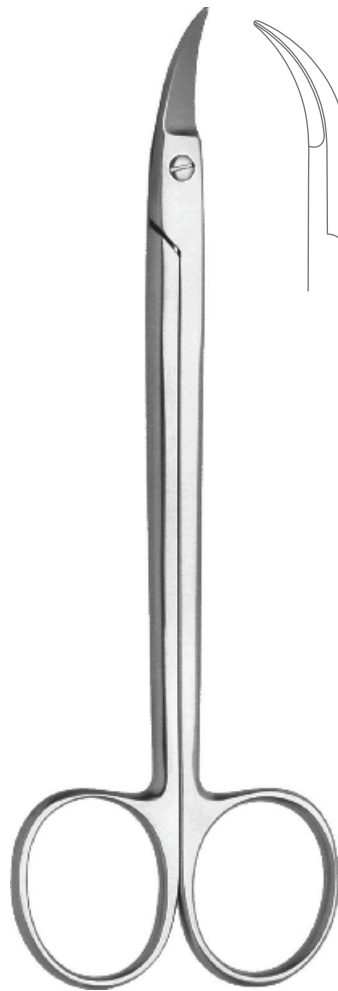

EI-473-13
Quimby Delicate Scissor
 Curved
 Overall Length 13 cm (5")



EI-4EI-09
O'Brien Stitch Scissor
 Angled
 Overall Length 9.5 cm (3 ¾")

Dissecting Scissors
Präparierscheren
Tijeras de disección
Ciseaux à dissection
Forbici per dissezione

EVA

SCISSORS

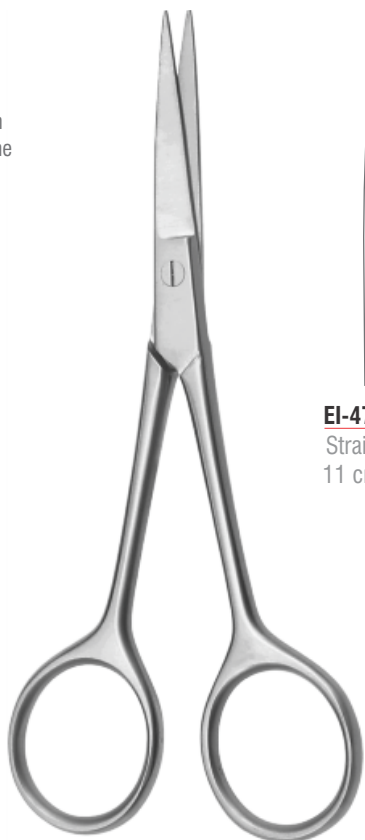

Quimby Dissecting Scissor



EI-476-11
Straight
11 cm (4 1/2")



EI-476-13
Straight
13 cm (5")

EI-4EI-11
Curved
13 cm (5")

EI-4EI-13
Curved
13 cm (5")



EI-481-11
Delicate Scissor
Angled to side
11.5 cm (4 1/2")



Ribbon Ophthalmic Scissors
Band-Augenschere
Tijera oftálmica de cinta
Ciseaux ophtalmiques à ruban
Forbici oftalmica a nastro



EI-484-09
Salyer Ribbon Scissor
Straight, Flat Shanks
Overall Length 9.5 cm (3 3/4")



Iris Scissor (Ribbon Type)
Overall Length 9.5 cm (3 3/4")
EI-486-09
Straight, Sharp, Flat Shanks



Iris Scissor (Ribbon Type)
Overall Length 10 cm (4")
EI-488-10
Straight, Blunt, Flat Shanks



Strabismus Scissor (Ribbon Type)
Overall Length 10 cm (4")

EI-492-10
Straight, Flat Shanks

EI-493-10
Curved, Flat Shanks

EI-487-09
Curved, Sharp, Flat Shanks

EI-489-10
Curved, Blunt, Flat Shanks

Ribbon Ophthalmic Scissors
Band-Augenschere
Tijera oftálmica de cinta
Ciseaux ophtalmiques à ruban
Forbici oftalmica a nastro

EVA

SCISSORS



Stevens Tenotomy Scissor (Ribbon Type)
Overall Length 10 cm (4")

EI-496-10

Straight, Flat Shanks, Sharp Tips

EI-497-10

Curved, Flat Shanks, Sharp Tips

EI-498-10

Straight, Flat Shanks, Blunt Tips

EI-499-10

Curved, Flat Shanks, Blunt Tips



Gradle Scissor (Ribbon Type)
Overall Length 10 cm (4")

EI-500-10

Straight, Flat Shanks

EI-501-10

Curved, Flat Shanks



EI-507-11
Kaye Facelift Scissor (Ribbon Type)

Curved, Flat Shanks, Toothed
Overall Length 11 cm (4 ½")

Rectal Scissors
 Rektumschere
 Tijera para recto
 Ciseaux pour rectum
 Forbici per il retto



EI-520-21
Enterotomy Scissor
 One Probe Tip
 Overall Length 21.5 cm (8 1/2")

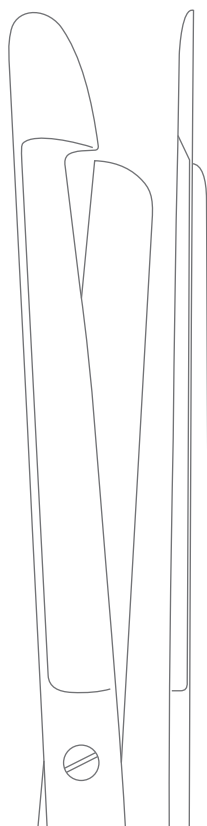

EI-522-21
Enterotomy Scissor
 One Probe Tip
 Overall Length 21.5 cm (8 1/2")

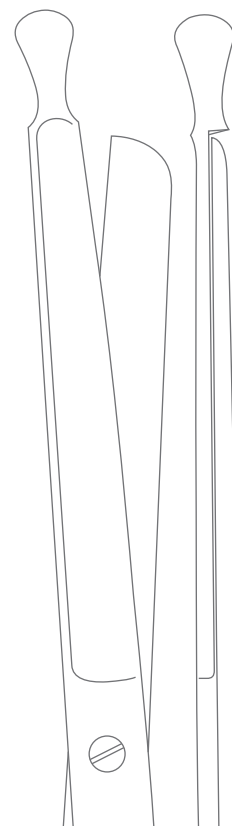

Rectal Scissors
Rektumschere
Tijera para recto
Ciseaux pour rectum
Forbici per il retto

EVA

SCISSORS

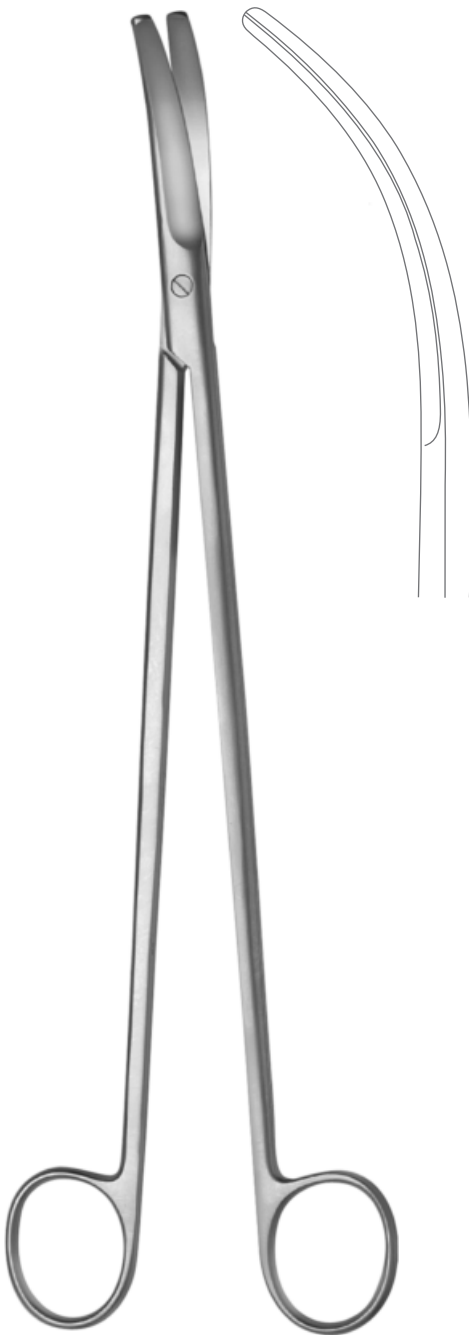

EI-525-32
Rectal Scissor
Curved Heavy Pattern
Overall Length 32.5 cm (12 3/4")



EI-527-28
Rectal Scissor
Angled 60°
Overall Length 28 cm (11")



Rectal Scissors
 Rektumschere
 Tijera para recto
 Ciseaux pour rectum
 Forbici per il retto



EI-529-27
Lloyd-Davies Goligher Rectal Scissor
 Curved
 Overall Length 27 cm (10 3/4")

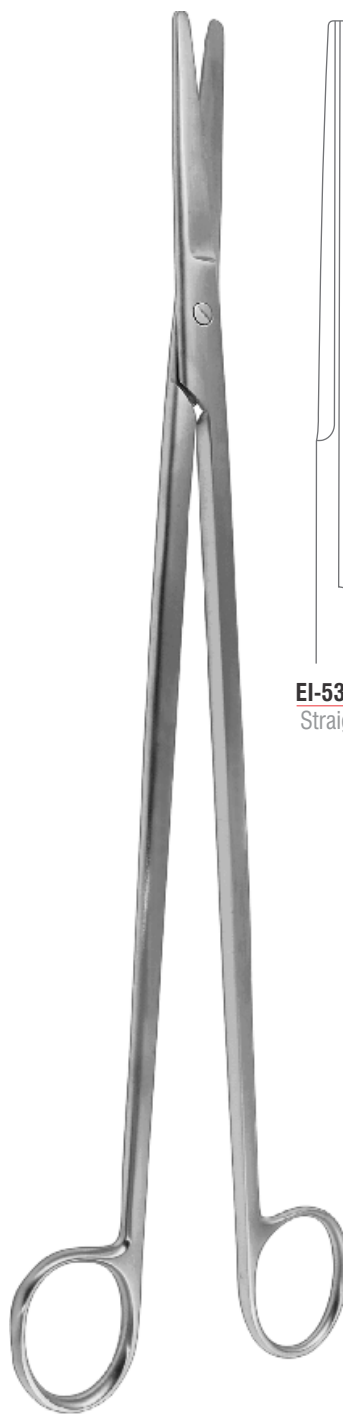

Stelzner Rectal Scissor
 Overall Length 31 cm (12 1/4")

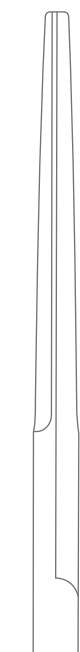

EI-530-31
 Straight



EI-531-31
 Curved

Rectal Scissors, Stitch Scissors
 Rektumschere, Fadenschere
 Tijera para recto, Tijeras para hilos
 Ciseaux pour rectum, Ciseaux à ligatures
 Forbici per il retto, Forbici per legature

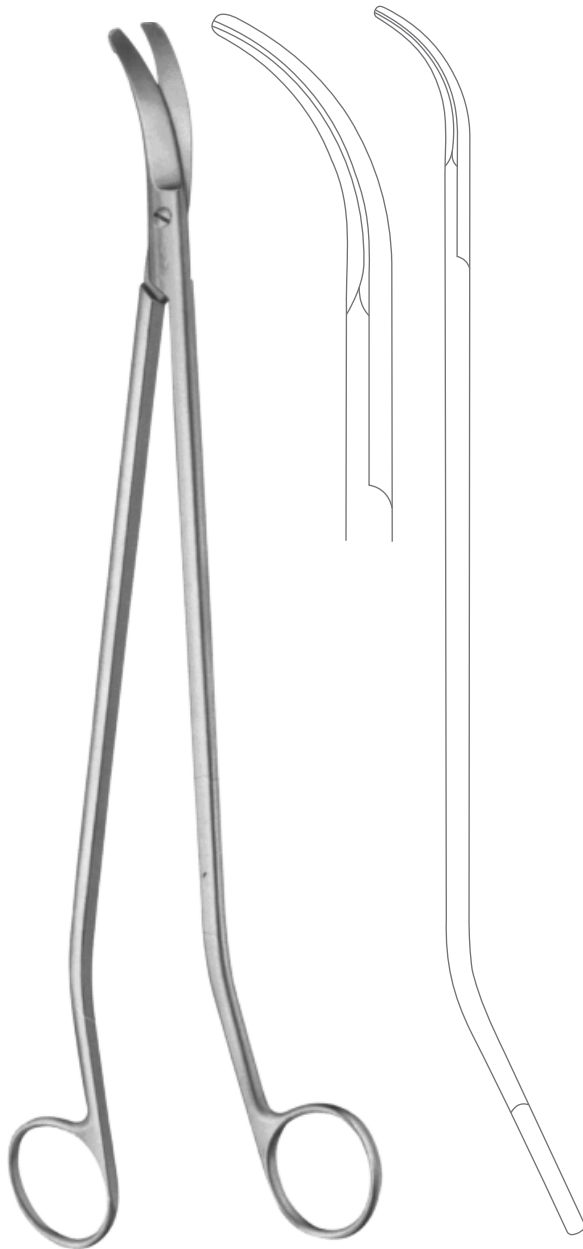

EI-533-32
Mueller Rectal Scissor
 S Shaped
 Overall Length 32.5 cm (12 3/4")

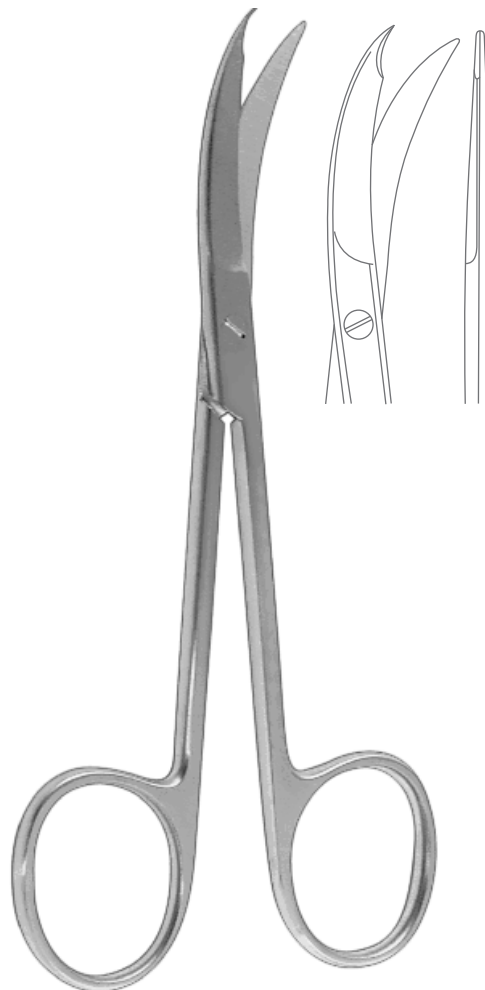

EI-540-13
Northbent Stitch Scissor
 Overall Length 13 cm (5")

Stitch Scissors
Fadenscheren
Tijeras para hilos
Ciseaux à ligatures
Forbici per legature



Spencer Stitch Scissor

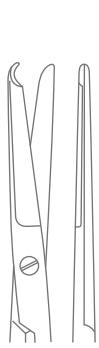

EI-542-09
9 cm (3 1/2")



EI-542-13
13 cm (5")



Buck Stitch Scissor

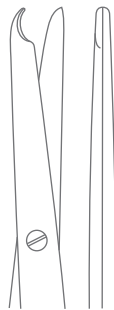

EI-544-14
14.5 cm (5 3/4")

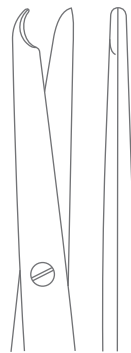

EI-544-18
18 cm (7")

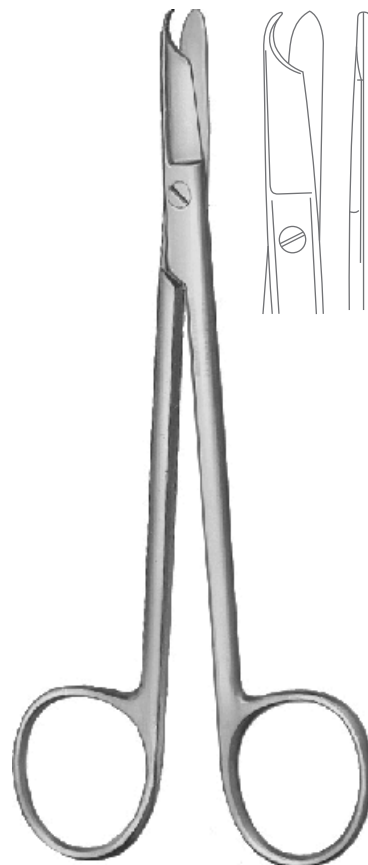

EI-546-14
Littauer Stitch Scissor
Overall Length 14 cm (5 1/2")

Stitch Scissors
Fadenscheren
Tijeras para hilos
Ciseaux à ligatures
Forbici per legature

EVA

SCISSORS



EI-548-12
Eiselberg Stitch Scissor
Overall Length 12 cm (4 3/4")

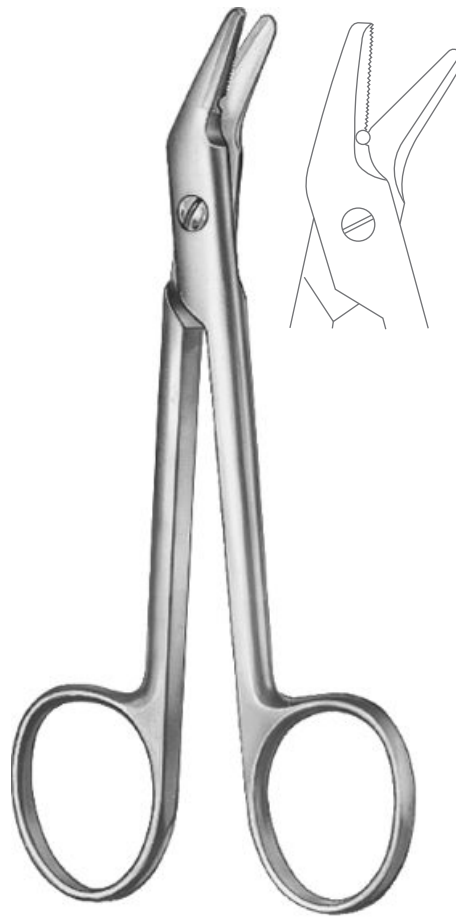

EI-551-12
Universal Wire Cutting Scissor
Angled, One Toothed Cutting Edge
Overall Length 12 cm (4 3/4")

Wire Cutting Scissors
 Drahtscheren
 Tijeras para cortar hilos de acero
 Ciseaux coupe-fil
 Forbici per tagliare fili metallic



EI-553-12
Heath Suture Scissor
 One Toothed Cutting Edge
 Overall Length 16 cm (6 1/4")



EI-554-12
Harvey Wire Cutting Scissor
 Straight, One Toothed Cutting Edge
 Overall Length 12.5 cm (5")

Crown Scissors, Nail Scissors
Kronenscheren, Nagelscheren
Tijeras para coronas, Tijeras para uñas
Ciseaux à couronnes, Ciseaux à ongles
Forbici per corone, Forbici per unghie

EVA

SCISSORS



Beebee Crown Scissor



EI-556-10
Straight
10.5 cm (4 1/4")



EI-557-10
Curved
10.5 cm (4 1/4")

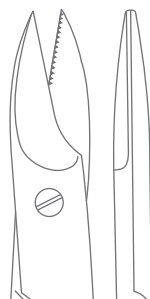

EI-558-12
Straight
12 cm (4 3/4")

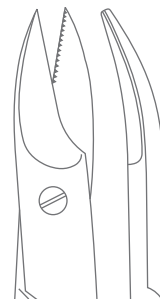

EI-559-12
Curved
12 cm (4 3/4")



EI-571-09
Nail Scissor
Curved
Overall Length 9 cm (3 1/2")



EI-573-09
Nail Scissor
Curved, Delicate Pattern
Overall Length 9 cm (3 1/2")

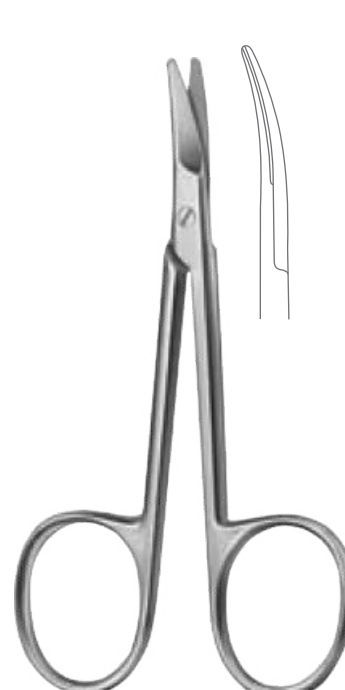

EI-5EI-09
Nail Scissor
Curved
Overall Length 8.5 cm (3 1/4")

Nail Scissors
Nagelscheren
Tijeras para uñas
Ciseaux à ongles
Forbici per unghie



Nail Scissor



EI-576-09
Straight
9 cm (3 1/2")



EI-5EI-09
Curved
9 cm (3 1/2")



EI-5EI-09
Curved
10 cm (4")



EI-5EI-09
Curved
11 cm (4 1/2")



EI-5EI-09
Straight
9.5 cm (3 3/4")



EI-579-09
Curved
9.5 cm (3 3/4")



EI-579-10
Curved
9.5 cm (3 3/4")

Bandage Scissors
Verbandscheren
Tijeras para vendajes
Ciseaux pour pansements
Forbici per bendaggi

EVA

SCISSORS



Smith (Mod. USA) Bandage Scissor
One Large Ring



EI-582-18
18 cm (7")

EI-582-20
20 cm (8")

EI-583-23
23 cm (9")

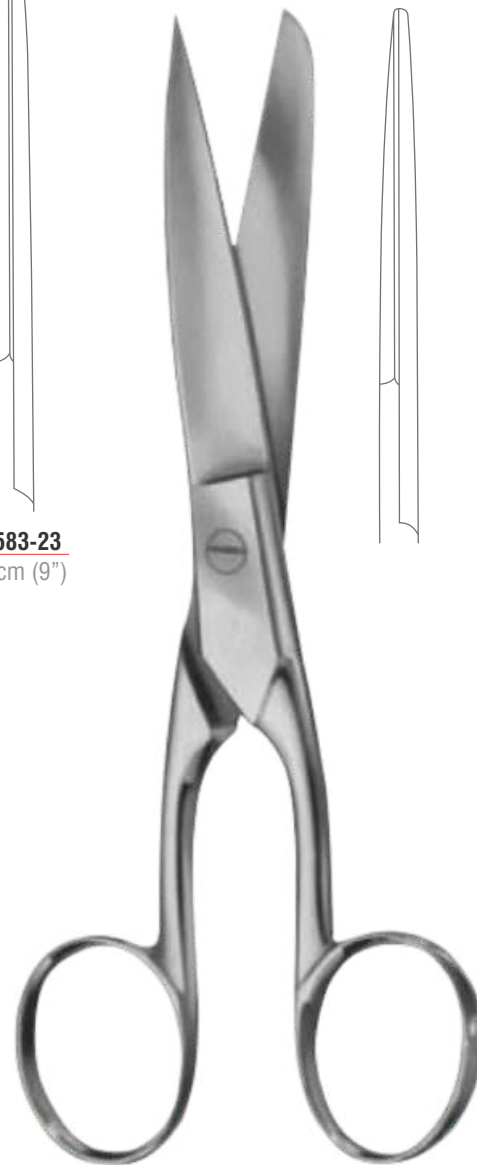

EI-584-15
Bandage Scissor
Straight
Overall Length 15 cm (6")

Bandage Scissors
Verbandscheren
Tijeras para vendajes
Ciseaux pour pansements
Forbici per bendaggi

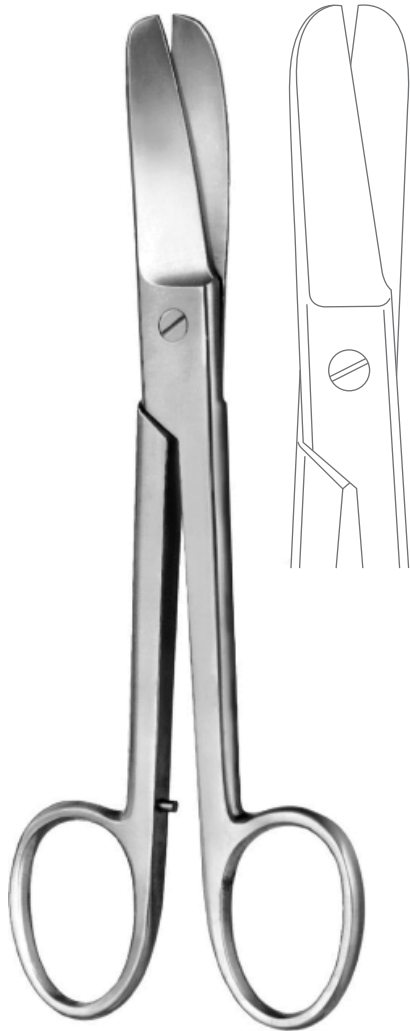

EI-585-23
Lorenz Bandage Scissor
Heavy Pattern
Overall Length 23 cm (9")



EI-587-14
Knowles Bandage Scissor
Angled
Overall Length 14 cm (5 1/2")

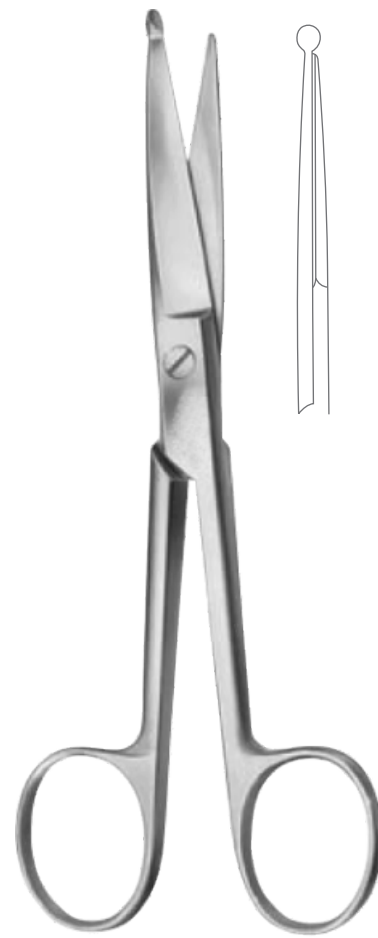

EI-588-14
Knowles Bandage Scissor (For Fingers)
Straight
Overall Length 14 cm (5 1/2")

Bandage Scissors
Verbandscheren
Tijeras para vendajes
Ciseaux pour pansements
Forbici per bendaggi

EVA

SCISSORS



- EI-591-14**
14.5 cm (5 3/4")
- EI-591-18**
18.5 cm (7 1/4")
- EI-591-20**
20 cm (8")

Lister Bandage Scissor

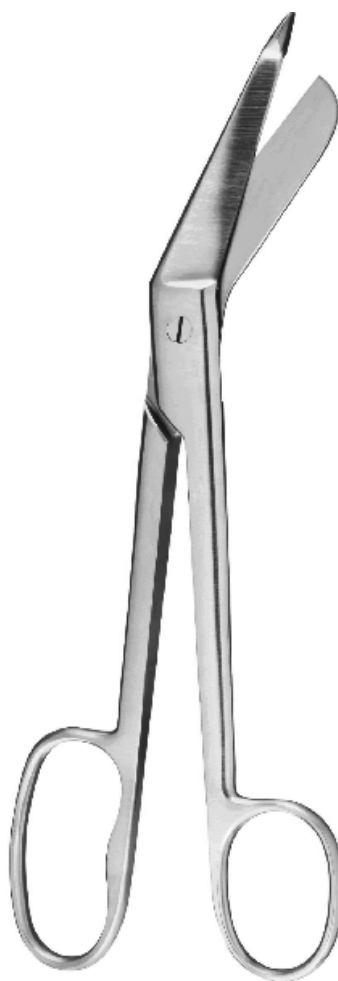

- EI-593-18**
- EI-593-21**

Lister Bandage Scissor
One Large Ring
Overall Length 18.5 cm (7 1/4")

Bandage Scissors
Verbandscheren
Tijeras para vendajes
Ciseaux pour pansements
Forbici per bendaggi



Lister (Eccentric) Bandage Scissor
One Toothed Cutting Edge

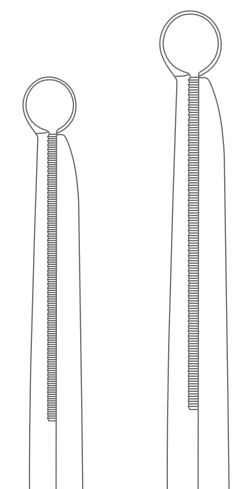

EI-595-16
16 cm (6 1/4")

EI-595-19
19 cm (7 1/2")

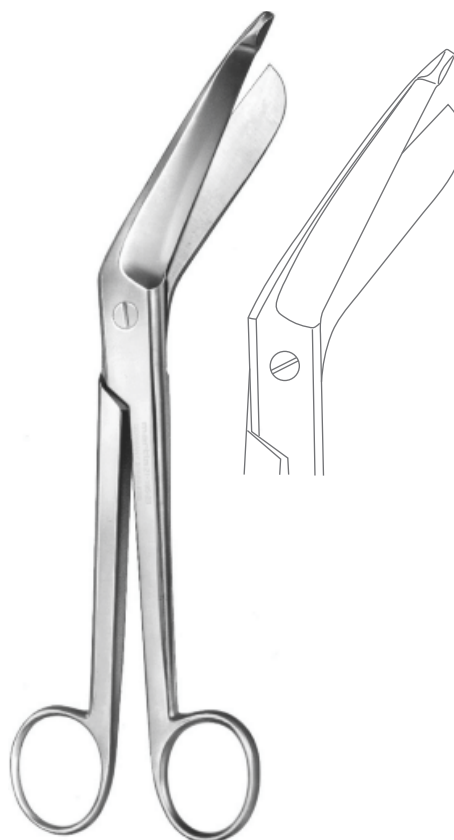

EI-597-23
Bergmann Bandage Scissor
Heavy Pattern
Overall Length 23.5 cm (9 1/4")



Esmarch Bandage Scissor
Heavy Pattern, Short Blades

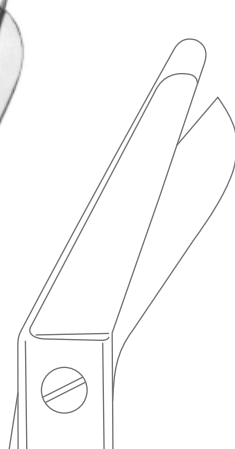

EI-599-20
20 cm (8")



EI-599-23
23 cm (9")

Bandage Scissors
Verbandscheren
Tijeras para vendajes
Ciseaux pour pansements
Forbici per bendaggi

EVA

SCISSORS



Universal Bandage Scissor
Plastic Handle

Codes	Size	Handle Colour
<u>EI-601-14</u>	14.5 cm (5 ¾")	Black
<u>EI-601-16</u>	16 cm (6 ¼")	Black
<u>EI-601-18</u>	18 cm (7 ½")	Black
<u>EI-603-14</u>	14.5 cm (5 ¾")	Blue
<u>EI-603-16</u>	16 cm (6 ¼")	Blue
<u>EI-603-18</u>	18 cm (7 ½")	Blue
<u>EI-605-14</u>	14.5 cm (5 ¾")	Red
<u>EI-605-16</u>	16 cm (6 ¼")	Red
<u>EI-605-18</u>	18 cm (7 ½")	Red
<u>EI-607-14</u>	14.5 cm (5 ¾")	Green
<u>EI-607-16</u>	16 cm (6 ¼")	Green
<u>EI-607-18</u>	18 cm (7 ½")	Green

Plaster Shears
Gipsscheren
Tijeras para yeso
Ciseaux pour plâtre
Forbici per gesso



EI-609-23
Seutin Plaster of Paris Shear
Overall Length 23 cm (9")



EI-611-20
Seutin Plaster of Paris Shear
One Toothed Cutting Edge
Overall Length 20 cm (8")

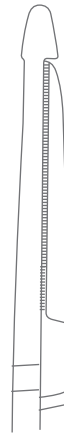

EI-613-24
Bruns Plaster of Paris Shear
One Toothed Cutting Edge
Overall Length 24 cm (9 1/2")

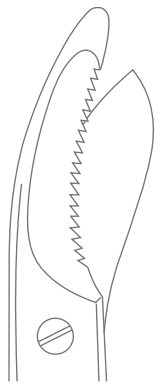

Micro Scissors
Mikroscheren
Micro-Tijeras
Micro-Ciseaux
Micro-Forbici



EI-620-01
Straight
Blunt/Blunt

EI-620-02
Straight
Sharp/Blunt

EI-620-03
Straight
Sharp/Sharp

Mueller Micro Scissor

Round Handle
Overall Length 12 cm (4 3/4")



EI-621-01
Curved
Blunt/Blunt

EI-621-02
Curved
Sharp/Blunt

EI-621-03
Curved
Sharp/Sharp

Mueller Micro Scissor

Round Handle
Overall Length 12 cm (4 3/4")



EI-622-01
Straight
Blunt/Blunt

EI-622-02
Straight
Sharp/Blunt

EI-622-03
Straight
Sharp/Sharp

Mueller Micro Scissor

Round Handle
Overall Length 15 cm (6")



EI-623-01
Curved
Blunt/Blunt

EI-623-02
Curved
Sharp/Blunt

EI-623-03
Curved
Sharp/Sharp

Mueller Micro Scissor

Round Handle
Overall Length 15 cm (6")

Micro Scissors
Mikroscheren
Micro-Tijeras
Micro-Ciseaux
Micro-Forbici

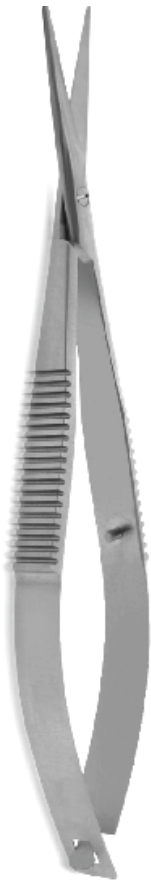

EI-626-01
Williamson-Noble Micro Scissor
Straight, Sharp/Sharp 27 mm Long Blades With
Max. 14 mm Cutting Edge
Overall Length 11.5 cm (4 3/4")



Noyes Iris Scissor
Sharp/Sharp, 23 mm Long Blades
with Max. 14 mm Cutting Edge
Overall Length 12.5 cm (5")



EI-630-12
Straight

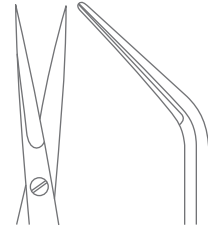

EI-631-12
Curved

Bandage Scissors
Verbandscheren
Tijeras para vendajes
Ciseaux pour pansements
Forbici per bendaggi

EVA

SCISSORS



EI-632-12
Straight

EI-633-12
Curved

Noyes Iris Scissor
Sharp/Blunt
23 mm Long Blades With Max. 14 mm Cutting Edge
Overall Length 12.5 cm (5")



EI-634-12
Straight

EI-635-12
Curved

Noyes Iris Scissor
Blunt/Blunt
23 mm Long Blades With Max. 14 mm Cutting Edge
Overall Length 12.5 cm (5")

Micro Scissors
Mikroscheren
Micro-Tijeras
Micro-Ciseaux
Micro-Forbici



EI-636-12
Straight



EI-6EI-12
Curved



EI-638-10
Osher IOL Cutting Scissor
Straight
Micro Serrated Cutting Edge With
Blunt Tip 10 mm Long Blades With
Max. 5 mm Cutting Edge
Overall Length 10 cm (4")

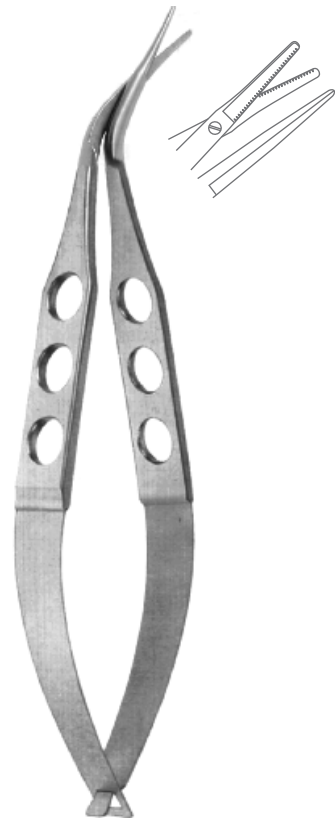
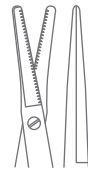

EI-639-10
Osher IOL Cutting Scissor
Angled
Micro Serrated Cutting Edge With
Blunt Tip 10 mm Long Blades With
Max. 5 mm Cutting Edge
Overall Length 10 cm (4")



Plaster Shears
Gipsscheren
Tijeras para yeso
Ciseaux pour plâtre
Forbici per gesso

EVA

SCISSORS

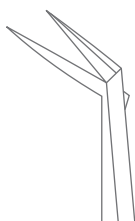

EI-641-11
Angled
Sharp/Sharp

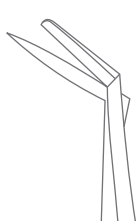

EI-643-11
Angled
Sharp/Blunt

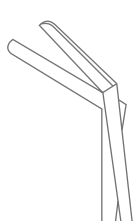

EI-645-11
Angled
Blunt/Blunt

Wecker Iris Scissor
8 mm Long Blades With Max. 5 mm Cutting Edge
Overall Length 11 cm (4 1/2")



EI-647-05
Angled, 5 mm

EI-647-07
Angled, 7 mm

EI-647-10
Angled, 10 mm

Barraquer Iris Scissor
9 mm Long Blades Max. 6 mm Cutting Edge
Overall Length 5.5 cm (2 1/4")



Micro Scissors
Mikroscheren
Micro-Tijeras
Micro-Ciseaux
Micro-Forbici



EI-649-01
Curved Right



EI-649-02
Curved Left

Holland DALK Scissor
Blunt Tips With Spatulated Inner Blade
8 mm Long Blades With
Max. 4 mm Cutting Edge
Overall Length 10.5 cm (4")



Castroviejo Corneoscleral Scissor
8 mm Long Blades With
Max. 4 mm Cutting Edge
Overall Length 10.5 cm (4")

EI-651-01
Curved Right

EI-651-02
Curved Left



Castroviejo Corneoscleral Scissor
12 mm Long Blades With
Max. 7 mm Cutting Edge
Overall Length 11 cm (4")

EI-653-01
Curved Right

EI-653-02
Curved Left

Micro Scissors
Mikroscheren
Micro-Tijeras
Micro-Ciseaux
Micro-Forbici

EVA

SCISSORS



Troutman-Castroviejo Corneoscleral Scissor
With Lock
8 mm Long Blades With Max. 4 mm Cutting Edge
Overall Length 10.5 cm (4")

EI-655-01
Curved Right

EI-655-02
Curved Left



Troutman-Castroviejo Corneoscleral Scissor
With Lock
12 mm Long Blades With Max. 7 mm Cutting Edge
Overall Length 11 cm (4 ½")

EI-657-01
Curved Right

EI-657-02
Curved Left

Micro Scissors
Mikroscheren
Micro-Tijeras
Micro-Ciseaux
Micro-Forbici



Troutman-Katzin Corneal Transplant Scissor
Strongly Curved, With Lock
8 mm Long Blades With Max. 4 mm Cutting Edge
Overall Length 10.5 cm (4")

EI-659-01
Curved Right

EI-659-02
Curved Left



Katzin Corneal Transplant Scissor
Strongly Curved
13 mm Long Blades With Max. 7 mm Cutting Edge
Overall Length 11 cm (4 1/2")

EI-661-01
Curved Right

EI-661-02
Curved Left

Micro Scissors
Mikroscheren
Micro-Tijeras
Micro-Ciseaux
Micro-Forbici

EVA

SCISSORS



Castroviejo Universal Corneal Scissor

Curved, Blunt Tips
Overall Length 11 cm (4 1/2")

EI-663-11

10 mm Long Blades With
Max. 5 mm Cutting Edge

EI-665-11

12 mm Long Blades With
Max. 6 mm Cutting Edge

EI-667-11

14 mm Long Blades With
Max. 8 mm Cutting Edge



EI-669-11

Castroviejo Universal Corneal Scissor

Strongly Curved, Blunt Tips 15 mm Long Blades With
Max. 9 mm Cutting Edge
Overall Length 11.5 cm (4 1/2")

Micro Scissors
Mikroscheren
Micro-Tijeras
Micro-Ciseaux
Micro-Forbici



EI-671-11
Castroviejo Keratoplasty Scissor
Angled to Side, Blunt Tips
14 mm Long Blades With
Max. 9 mm Cutting Edge
Overall Length 11.5 cm (4 1/2")



EI-673-11
McPherson-Westcott Conjunctival Scissor
Curved, Blunt Tips
10 mm Long Blades With
Max. 5 mm Cutting Edge
Overall Length 11 cm (4 1/2")



EI-6EI-11
Westcott Tenotomy Scissor
Curved, Blunt Tips
14 mm Long Blades With
Max. 8 mm Cutting Edge
Overall Length 11 cm (4 1/2")

Micro Scissors
Mikroscheren
Micro-Tijeras
Micro-Ciseaux
Micro-Forbici

EVA

SCISSORS



Westcott Tenotomy Scissor

Blunt Tips
20 mm Long Blades With
Max. 10 mm Cutting Edge
Overall Length 11 cm (4 1/2")

EI-6EI-01

Curved Right

EI-6EI-02

Curved Left



EI-679-11

Tibolt Punctal Scissor

One Conically Shaped Blade With
Micro Grooves & Textured Surface
15 mm Long Blades With
Max. 8 mm Cutting Edge
Overall Length 11.5 cm (4 1/2")



EI-681-11

McPherson-Westcott Stitch Scissor

Curved, Very Sharp Pointed Tips, Small Blades
10 mm Long Blades With
Max. 5 mm Cutting Edge
Overall Length 11 cm (4 1/2")

Micro Scissors
Mikroscheren
Micro-Tijeras
Micro-Ciseaux
Micro-Forbici



EI-683-11
Westcott Stitch Scissor
Curved, Very Sharp Pointed Tips
20 mm Long Blades With
Max. 10 mm Cutting Edge
Overall Length 11.5 cm (4 ½")



EI-685-11
Jaffe Stitch Scissor
Curved, Very Sharp Pointed Tips
13 mm Long Blades With
Max. 7 mm Cutting Edge
Overall Length 11 cm (4 ½")



EI-688-11
Iris Micro Scissor
Straight, Sharp Tips
10 mm Long Blades With
Max. 5 mm Cutting Edge
Overall Length 11 cm (4 ½")



EI-689-11
Iris Micro Scissor
Curved, Sharp Tips
10 mm Long Blades With
Max. 5 mm Cutting Edge
Overall Length 11 cm (4 ½")

Micro Scissors
Mikroscheren
Micro-Tijeras
Micro-Ciseaux
Micro-Forbici

EVA

SCISSORS



EI-690-11
Fine Micro Scissor
Straight, Sharp Tips
17 mm Long Blades With
Max. 9 mm Cutting Edge
Overall Length 11.5 cm (4 ½")



EI-691-11
Fine Micro Scissor
Curved, Sharp Tips
17 mm Long Blades With
Max. 9 mm Cutting Edge
Overall Length 11.5 cm (4 ½")



EI-694-08
Vannas Capsulotomy Scissor
Straight, Sharp Tips
5 mm Long Blades With
Max. 3 mm Cutting Edge
Overall Length 8 cm (3 ¼")



EI-695-08
Vannas Capsulotomy Scissor
Curved, Sharp Tips
5 mm Long Blades With
Max. 3 mm Cutting Edge
Overall Length 8 cm (3 ¼")

Micro Scissors
Mikroscheren
Micro-Tijeras
Micro-Ciseaux
Micro-Forbici

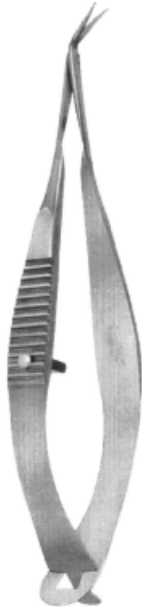

EI-696-08
Vannas Capsulotomy Scissor
Angled Forward, Sharp Tips 5 mm Long Blades With
Max. 3 mm Cutting Edge
Overall Length 8 cm (3 1/4")



EI-697-08
Vannas Capsulotomy Scissor
Angled to Side, Sharp Tips 5 mm Long Blades With
Max. 3 mm Cutting Edge
Overall Length 8 cm (3 1/4")



EI-698-08
Gills-Vannas Capsulotomy Scissor
Straight, Sharp Tips 7 mm Long Blades With
Max. 3 mm Cutting Edge
Overall Length 8 cm (3 1/4")



EI-699-08
Gills-Vannas Capsulotomy Scissor
Curved, Sharp Tips 7 mm Long Blades With
Max. 3 mm Cutting Edge
Overall Length 8 cm (3 1/4")

Micro Scissors
Mikroscheren
Micro-Tijeras
Micro-Ciseaux
Micro-Forbici

EVA

SCISSORS



EI-701-08
Gills-Vannas Capsulotomy Scissor
Angled Forward, Sharp Tips 7 mm
Long Blades With Max. 3 mm Cutting Edge
Overall Length 8 cm (3 1/4")



EI-703-08
McPherson-Vannas Capsulotomy Scissor
Curved, Sharp Tips 8 mm
Long Blades With Max. 3 mm Cutting Edge
Overall Length 8 cm (3 1/4")



EI-705-08
Holland DALK Scissor
Angled Blades With Blunt Tips
5 mm Long Blades With Max. 3 mm
Cutting Edge
Overall Length 8 cm (3 1/4")

Micro Scissors
Mikroscheren
Micro-Tijeras
Micro-Ciseaux
Micro-Forbici



EI-706-10
Gills-Vannas Micro Scissor
Straight, Extra Thin Blades
Sharp Tips
7 mm Long Blades With
Max. 3 mm Cutting Edge
Overall Length 10.5 cm (4")



EI-707-10
Gills-Vannas Micro Scissor
Curved, Extra Thin Blades
Sharp Tips
7 mm Long Blades With
Max. 3 mm Cutting Edge
Overall Length 10.5 cm (4")



EI-709-10
Gills-Vannas Micro Scissor
Angled Forward, Extra Thin Blades
Sharp Tips
7 mm Long Blades With
Max. 3 mm Cutting Edge
Overall Length 10.5 cm (4")

Micro Scissors
Mikroscheren
Micro-Tijeras
Micro-Ciseaux
Micro-Forbici

EVA

SCISSORS



EI-710-11
Stern-Gills Micro Scissor
Straight, Extra Thin Blades
Sharp Tips
10 mm Long Blades With
Max. 4 mm Cutting Edge
Overall Length 11 cm (4 ½")



EI-711-11
Stern-Gills Micro Scissor
Curved, Extra Thin Blades
Sharp Tips
10 mm Long Blades With
Max. 4 mm Cutting Edge
Overall Length 11 cm (4 ½")



EI-713-11
Stern-Gills Micro Scissor
Angled Forward, Extra Thin
Blades Sharp Tips
10 mm Long Blades With
Max. 4 mm Cutting Edge
Overall Length 11 cm (4 ½")



EI-715-11
Gills Capsulotomy Scissor
Angled Blades With Curved Sharp
Tips 10 mm Long Blades With
Max. 4 mm Cutting Edge
Overall Length 10.5 cm (4 ½")



Micro Scissors
Mikroscheren
Micro-Tijeras
Micro-Ciseaux
Micro-Forbici



Vitrectomy Scissor
Overall Length 14 cm (5 1/2")



EI-720-20
Straight
Horizontal Opening
20 G



EI-721-20
Curved
Horizontal Opening
20 G



EI-721-30
Angled 30°
Horizontal Opening
20 G



EI-721-23
Curved
Horizontal Opening
23 G



EI-721-45
Angled 45°
Horizontal Opening
20 G



EI-723-23
Vertical
Straight, 23 G



EI-723-60
Angled 60°
Horizontal Opening
20 G



EI-723-80
Angled 80°
Horizontal Opening
20 G



EI-725-23
Alio MICS Scissor
Curved, 23 G
Shaft With Horizontal Membranes
for Cutting Delicate Membranes
Overall Length 14 cm (5 1/2")

Micro Scissors
Mikroscheren
Micro-Tijeras
Micro-Ciseaux
Micro-Forbici

EVA

SCISSORS



EI-726-12
Vannas Micro Scissor
Straight, 10 mm Long Blades With
Max. 4 mm Cutting Edge
Overall Length 12 cm (4 3/4")



EI-727-12
Vannas Micro Scissor
Curved, 10 mm Long Blades With
Max. 4 mm Cutting Edge
Overall Length 12 cm (4 3/4")



EI-729-12
Vannas Micro Scissor
Angled on Flat, 10 mm Long Blades With
Max. 4 mm Cutting Edge
Overall Length 12 cm (4 3/4")

Micro Scissors
Mikroscheren
Micro-Tijeras
Micro-Ciseaux
Micro-Forbici

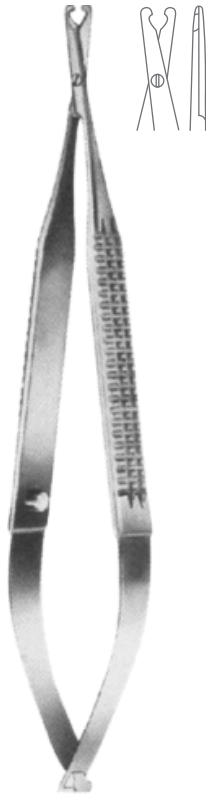

EI-730-13
Biemer Vein Scissor
Overall Length 13 cm (5")



Micro Scissor
Overall Length 16 cm (6 1/4")



EI-732-16
Straight



EI-733-16
Curved

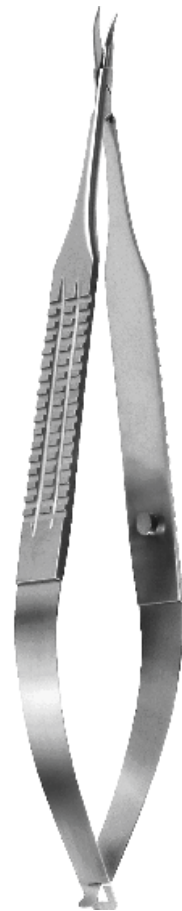

Vannas Micro Scissor
Overall Length 16 cm (6 1/4")



EI-734-16
Straight



EI-735-16
Curved

Micro Scissors
Mikroscheren
Micro-Tijeras
Micro-Ciseaux
Micro-Forbici

EVA

SCISSORS

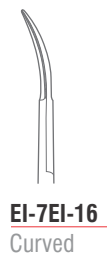
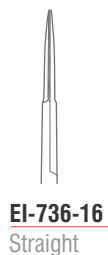

Millesi Micro Scissor
Serrated
Overall Length 16 cm (6 1/4")

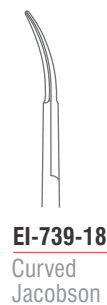
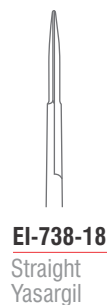

Yasargil Micro Scissor
Overall Length 18.5 cm (7 1/4")

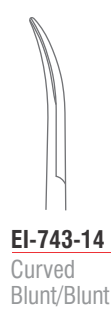
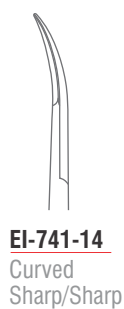
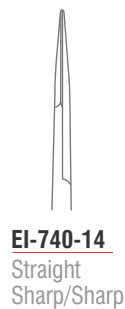

Adventitia Micro Scissor
Overall Length 14.5 cm (5 3/4")

Micro Scissors
Mikroscheren
Micro-Tijeras
Micro-Ciseaux
Micro-Forbici



Micro Scissor
Overall Length 16.5 cm (6 1/2")

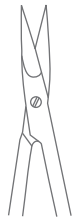

EI-744-16
Straight
Delicate Blades



EI-745-16
Curved
Delicate Blades



EI-746-16
Straight
Extra Delicate Blades



EI-747-16
Curved
Extra Delicate Blades

Micro Scissors
Mikroscheren
Micro-Tijeras
Micro-Ciseaux
Micro-Forbici

EVA

SCISSORS

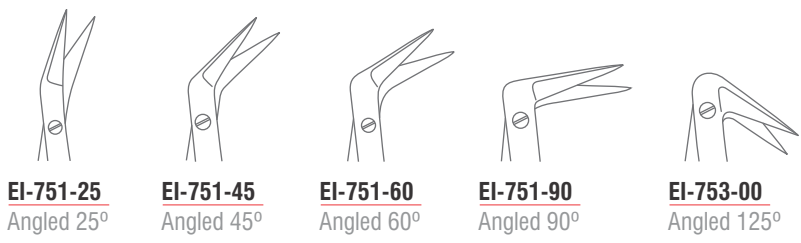

Micro Coronary Scissor
Overall Length 18 cm (7")

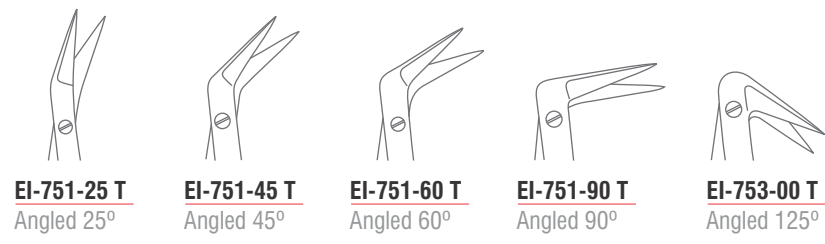
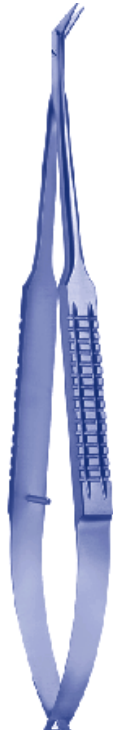

Micro Coronary Scissor
Overall Length 18 cm (7")

Micro Scissors
Mikroscheren
Micro-Tijeras
Micro-Ciseaux
Micro-Forbici



Micro Coronary Scissor
Overall Length 16.5 cm (6 1/2")



EI-755-25
Fine Blades
Angled 25°



EI-755-45
Fine Blades
Angled 45°

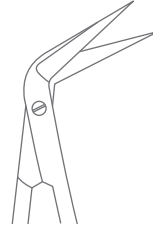

EI-755-60
Fine Blades
Angled 60°

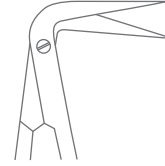

EI-755-90
Fine Blades
Angled 90°



EI-757-00
Fine Blades
Angled 125°



EI-759-25
Fine Blades
One Blade
Probe Tip
Angled 25°

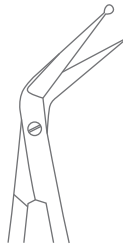

EI-759-45
Fine Blades
One Blade
Probe Tip
Angled 45°

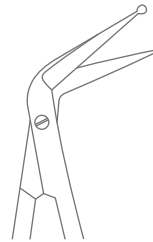

EI-759-60
Fine Blades
One Blade
Probe Tip
Angled 60°

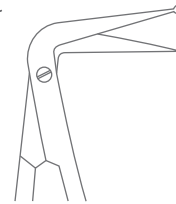

EI-759-90
Fine Blades
One Blade
Probe Tip
Angled 90°

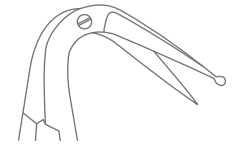

EI-761-00
Fine Blades
One Blade
Probe Tip
Angled 125°



EI-763-25
Delicate
Blades
Angled 25°



EI-763-45
Delicate
Blades
Angled 45°



EI-763-60
Delicate
Blades
Angled 60°

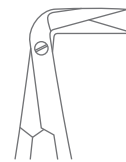

EI-763-90
Delicate
Blades
Angled 90°



EI-765-00
Delicate
Blades
Angled 125°



EI-767-25
Extra Delicate
Blades
Angled 25°



EI-767-45
Extra Delicate
Blades
Angled 45°

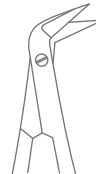

EI-767-60
Extra Delicate
Blades
Angled 60°

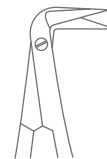

EI-767-90
Extra Delicate
Blades
Angled 90°



EI-769-00
Extra Delicate
Blades
Angled 125°

Micro Scissors
 Mikroscheren
 Micro-Tijeras
 Micro-Ciseaux
 Micro-Forbici

EVA

SCISSORS



Micro Coronary Scissor
 Round Handle
 Overall Length 16.5 cm (6 1/2")



EI-7EI-25
 Fine Blades
 Angled 25°

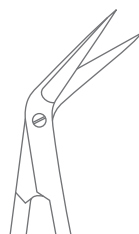

EI-7EI-45
 Fine Blades
 Angled 45°

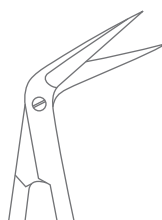

EI-7EI-60
 Fine Blades
 Angled 60°

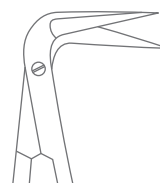

EI-7EI-90
 Fine Blades
 Angled 90°

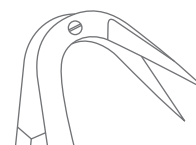

EI-7EI-00
 Fine Blades
 Angled 125°



EI-779-25
 Fine Blades
 One Blade
 Probe Tip
 Angled 25°



EI-779-45
 Fine Blades
 One Blade
 Probe Tip
 Angled 45°

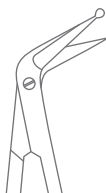

EI-779-60
 Fine Blades
 One Blade
 Probe Tip
 Angled 60°

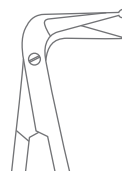

EI-779-90
 Fine Blades
 One Blade
 Probe Tip
 Angled 90°

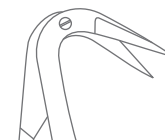

EI-781-00
 Fine Blades
 One Blade
 Probe Tip
 Angled 125°



Micro Scissors
Mikroscheren
Micro-Tijeras
Micro-Ciseaux
Micro-Forbici



Micro Coronary Scissor
Round Handle
Overall Length 16.5 cm (6 1/2")



EI-783-25
Delicate
Blades
Angled 25°

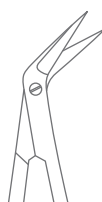

EI-783-45
Delicate
Blades
Angled 45°

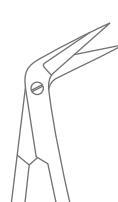

EI-783-60
Delicate
Blades
Angled 60°

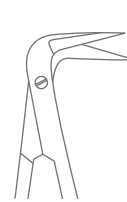

EI-783-90
Delicate
Blades
Angled 90°



EI-785-00
Delicate
Blades
Angled 125°



EI-787-25
Extra Delicate
Blades
Angled 25°



EI-787-45
Extra Delicate
Blades
Angled 45°



EI-787-60
Extra Delicate
Blades
Angled 60°



EI-787-90
Extra Delicate
Blades
Angled 90°

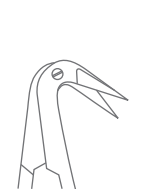

EI-789-00
Extra Delicate
Blades
Angled 125°

Micro Scissors
Mikroscheren
Micro-Tijeras
Micro-Ciseaux
Micro-Forbici

EVA

SCISSORS



EI-790-18
Straight



EI-791-18
Curved



EI-793-18
Curved
One Blade With
Probe Tip



EI-796-18
Straight
One Toothed
Cutting Edge

Micro Scissor
Round Handle
Overall Length 18 cm (7")

Micro Scissors
Mikroscheren
Micro-Tijeras
Micro-Ciseaux
Micro-Forbici



Micro Scissor
Round Handle



EI-800-15
Straight
15 cm (6")



EI-800-18
Straight
18 cm (7")



EI-800-21
Straight
21 cm (8 1/4")



EI-800-23
Straight
23 cm (9")



Micro Scissor
Round Handle



EI-800-15 T
Straight
15 cm (6")



EI-800-18 T
Straight
18 cm (7")



EI-800-21 T
Straight
21 cm (8 1/4")



Micro Scissors
Mikroscheren
Micro-Tijeras
Micro-Ciseaux
Micro-Forbici

EVA

SCISSORS



Micro Scissor
Round Handle



EI-801-15
Straight
15 cm (6")



EI-801-18
Straight
18 cm (7")



EI-801-21
Straight
21 cm (8 ¼")



EI-801-23
Straight
23 cm (9")



Micro Scissor
Round Handle



EI-801-15 T
Straight
15 cm (6")



EI-801-18 T
Straight
18 cm (7")



EI-801-21 T
Straight
21 cm (8 ¼")



TITANIUM

Micro Scissors
Mikroscheren
Micro-Tijeras
Micro-Ciseaux
Micro-Forbici



EI-804-15
Straight
15 cm (6")



EI-804-18
Straight
18 cm (7")



EI-804-21
Straight
21 cm (8 1/4")



EI-804-23
Straight
23 cm (9")

Micro Scissor
Blade Length 10 mm, Flat Handle



EI-804-15 T
Straight
15 cm (6")



EI-804-18 T
Straight
18 cm (7")



EI-804-21 T
Straight
21 cm (8 1/4")



TITANIUM

Micro Scissor
Blade Length 10 mm, Flat Handle

Micro Scissors
Mikroscheren
Micro-Tijeras
Micro-Ciseaux
Micro-Forbici

EVA

SCISSORS



EI-805-15
Straight
15 cm (6")



EI-805-18
Straight
18 cm (7")



EI-805-21
Straight
21 cm (8 1/4")



EI-805-23
Straight
23 cm (9")

Micro Scissor
Blade Length 10 mm, Flat Handle



EI-805-15 T
Straight
15 cm (6")



EI-805-18 T
Straight
18 cm (7")



EI-805-21 L
Straight
21 cm (8 1/4")



TITANIUM

Micro Scissor
Blade Length 10 mm, Flat Handle

Micro Scissors
Mikroscheren
Micro-Tijeras
Micro-Ciseaux
Micro-Forbici



EI-806-23
Straight, Blunt/Blunt

EI-807-23
Curved, Upwards

Yasargil Micro Scissor
Bayonet Shaped
Overall Length 23 cm (9")



EI-808-23
Jacobson
Straight
23 cm (9")



EI-809-23
Potts
Curved
23 cm (9")

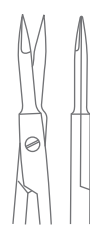

EI-810-23
Straight
23 cm (9")



EI-811-23
Curved
23 cm (9")



EI-814-19
Straight
18.5 cm (7 1/4")

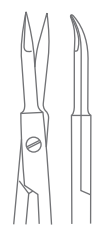

EI-815-19
Curved
18.5 cm (7 1/4")







Jacobson Micro Scissor
Bayonet Shaped

Micro Scissors
Mikroscheren
Micro-Tijeras
Micro-Ciseaux
Micro-Forbici

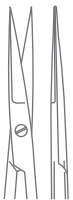
EVA

SCISSORS



					
<u>EI-816-19</u> Straight 19 cm (7 1/2")	<u>EI-816-21</u> Straight 21.5 cm (8 1/2")	<u>EI-817-19</u> Curved Downwards 19 cm (7 1/4")	<u>EI-817-21</u> Curved Downwards 21.5 cm (8 1/2")	<u>EI-819-19</u> Curved Upwards 19 cm (7 1/4")	<u>EI-819-21</u> Curved Upwards 21.5 cm (8 1/2")

Micro Scissor
Bayonet Shaped

Micro Scissors
Mikroscheren
Micro-Tijeras
Micro-Ciseaux
Micro-Forbici



Jaboma Micro Scissor
Angled, One Blade Probe Tip
Overall Length 18 cm (7")



EI-825-18
Right, 12 mm



EI-827-18
Left, 12 mm



EI-829-18
Systrunk Nail Splitting Scissor
12 mm
Overall Length 18 cm (7")

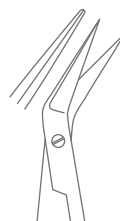

EI-8EI-21
Micro Scissor
Curved Upwards, Bayonet Shape
Overall Length 21 cm (8 1/4")

Operating Scissors
Chirurgische Scheren
Tijeras quirúrgicas
Ciseaux chirurgicaux
Forbici per chirurgia

EVA

SCISSORS



UltraCut™ TC Strabismus Scissor
Overall Length 11.5 cm (4 ½")

UltraCut™ TC Operating Scissor
Blunt/Blunt
Overall Length 14.5 cm (5 ¾")

ULTRACut™

ULTRACut™

Operating Scissors
Chirurgische Scheren
Tijeras quirúrgicas
Ciseaux chirurgicaux
Forbici per chirurgia

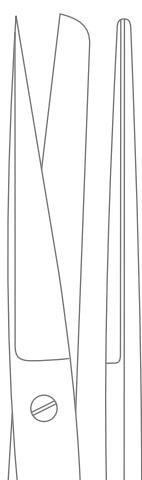

EI-852-14
Straight

UltraCut™ TC Operating Scissor
Sharp/Blunt
Overall Length 14.5 cm (5 ¾")

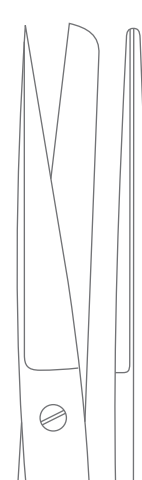

EI-852-14 SC
Straight

XTSCut™ TC Operating Scissor
Sharp/Blunt
Overall Length 14.5 cm (5 ¾")



Operating Scissors
Chirurgische Scheren
Tijeras quirúrgicas
Ciseaux chirurgicaux
Forbici per chirurgia

EVA

SCISSORS



EI-853-14
Curved

UltraCut™ TC Operating Scissor
Sharp/Blunt
14.5 cm (5 ¾")

ULTRA.Cut™



EI-853-14 SC
Curved

XTSCut™ TC Operating Scissor
Sharp/Blunt
14.5 cm (5 ¾")

XTS·cut™

Operating Scissors
Chirurgische Scheren
Tijeras quirúrgicas
Ciseaux chirurgicaux
Forbici per chirurgia

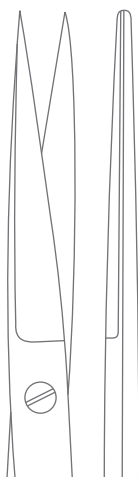

EI-854-14
Straight



EI-855-14
Curved

UltraCut™ TC Operating Scissor
Sharp/Sharp
Overall Length 14.5 cm (5 ¾")

ULTRA.Cut™

Dissecting Scissors
Präparierscheren
Tijeras de disección
Ciseaux à dissection
Forbici per dissezione

EVA

SCISSORS



EI-860-14
14.5 cm (5 ¾")



EI-860-17
17 cm (6 ¾")

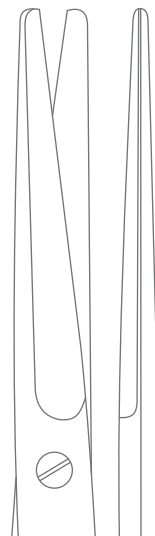

EI-860-23
23 cm (9")

ULTRACut™

UltraCut™ TC Mayo Dissecting Scissor
Straight



EI-860-14 SC
14.5 cm (5 ¾")



EI-860-17 SC
17 cm (6 ¾")

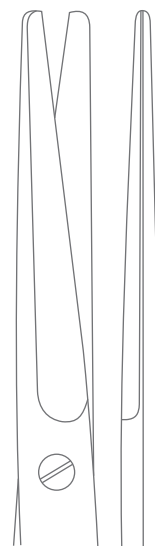

EI-860-23 SC
23 cm (9")

XTSCut™

XTSCut™ TC Mayo Dissecting Scissor
Straight

Dissecting Scissors
Präparierscheren
Tijeras de disección
Ciseaux à dissection
Forbici per dissezione



UltraCut™ TC Mayo Dissecting Scissor
Curved



EI-861-14
14.5 cm (5 3/4")

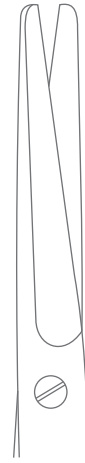

EI-861-17
17 cm (6 3/4")



EI-861-23
23 cm (9")

ULTRA *Cut*™



XTSCut™ TC Mayo Dissecting Scissor
Curved



EI-861-14 SC
14.5 cm (5 3/4")

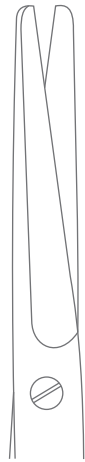

EI-861-17 SC
17 cm (6 3/4")

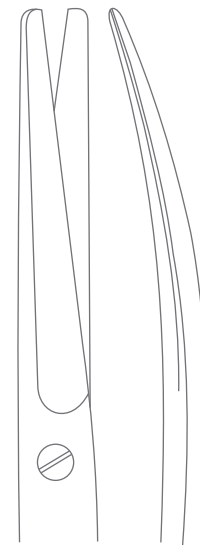

EI-861-23 SC
23 cm (9")

XTS *cut*™

Dissecting Scissors
 Präparierscheren
 Tijeras de disección
 Ciseaux à dissection
 Forbici per dissezione

EVA

SCISSORS

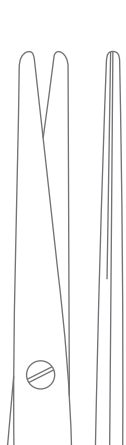

EI-890-15
15 cm (6")

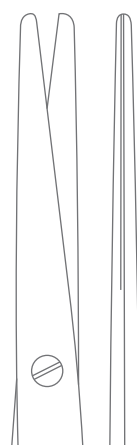

EI-890-17
17 cm (6 3/4")

ULTRA Cut™

UltraCut™ TC Mayo-Stille Dissecting Scissor
Straight

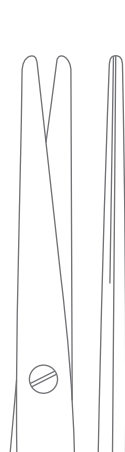

EI-890-15 SC
15 cm (6")

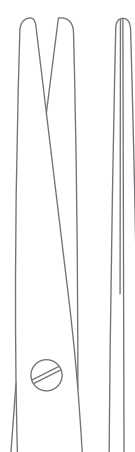

EI-890-17 SC
17 cm (6 3/4")

XTS Cut™

XTSCut™ TC Mayo-Stille Dissecting Scissor
Straight

Dissecting Scissors
Präparierscheren
Tijeras de disección
Ciseaux à dissection
Forbici per dissezione



EI-891-15
15 cm (6")



EI-891-17
17 cm (6 3/4")

ULTRA Cut™

UltraCut™ TC Mayo-Style Dissecting Scissor
Curved



EI-891-15 SC
15 cm (6")



EI-891-17 SC
17 cm (6 3/4")

XTS Cut™

XTSCut™ TC Mayo-Style Dissecting Scissor
Curved



Dissecting Scissors
Präparierscheren
Tijeras de disección
Ciseaux à dissection
Forbici per dissezione



EI-891-15
15 cm (6")



EI-891-17
17 cm (6 3/4")

ULTRA Cut™

UltraCut™ TC Mayo-Stille Dissecting Scissor
Curved



EI-891-15 SC
15 cm (6")



EI-891-17 SC
17 cm (6 3/4")

XTS Cut™

XTSCut™ TC Mayo-Stille Dissecting Scissor
Curved

Dissecting Scissors
Präparierscheren
Tijeras de disección
Ciseaux à dissection
Forbici per dissezione



EI-900-11

Straight

EI-901-11

Curved

ULTRACut™

UltraCut™ TC Metzenbaum Dissecting Scissor

Overall Length 11.5 cm (4 ½")



EI-902-14

Straight

EI-903-14

Curved

ULTRACut™

UltraCut™ TC Metzenbaum Dissecting Scissor

Overall Length 14.5 cm (5 ¾")

Dissecting Scissors
Präparierscheren
Tijeras de disección
Ciseaux à dissection
Forbici per dissezione



EI-902-14 SC
Straight

EI-903-14 SC
Curved

XTSCut^{TC} Metzenbaum Dissecting Scissor
Overall Length 14.5 cm (5 ¾")



Dissecting Scissors
Präparierscheren
Tijeras de disección
Ciseaux à dissection
Forbici per dissezione



UltraCut™ Metzenbaum-Nelson Dissecting Scissor
Straight, Blunt/Blunt

ULTRA *Cut*™

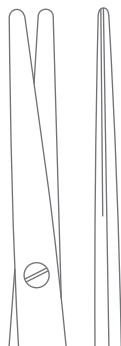

EI-904-18
18 cm (7")



EI-904-20
20.5 cm (8")

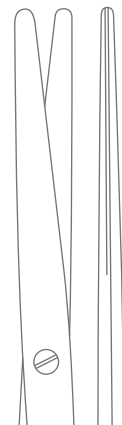

EI-904-23
23 cm (9")

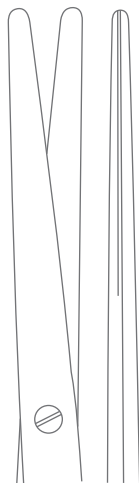

EI-904-25
26 cm (10 1/4")

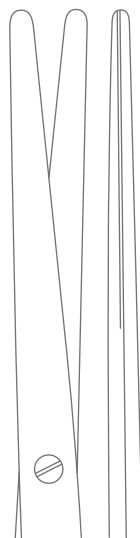

EI-904-28
28.5 cm (11 1/4")

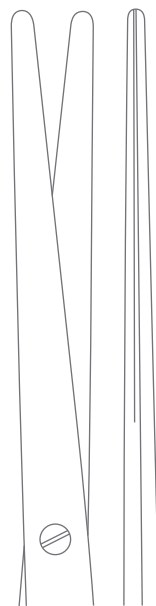

EI-904-30
31 cm (12 1/4")

Dissecting Scissors
 Präparierscheren
 Tijeras de disección
 Ciseaux à dissection
 Forbici per dissezione



EI-904-18
18 cm (7")

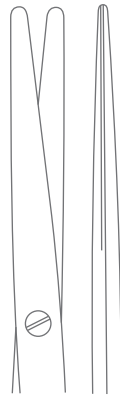

EI-904-20
20.5 cm (8")

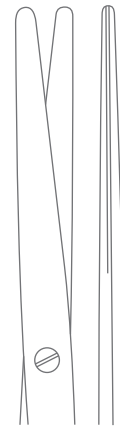

EI-904-23
23 cm (9")

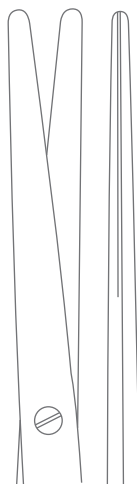

EI-904-25
26 cm (10 1/4")

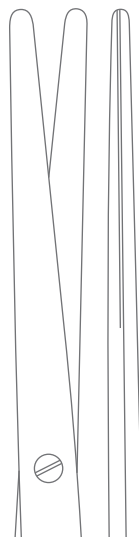

EI-904-28
28.5 cm (11 1/4")

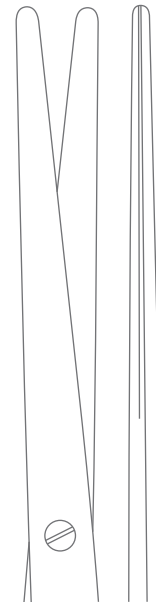

EI-904-30
31 cm (12 1/4")

UltraCut™ Metzenbaum-Nelson Dissecting Scissor
 Straight, Blunt/Blunt

ULTRA *Cut*™

Dissecting Scissors
Präparierscheren
Tijeras de disección
Ciseaux à dissection
Forbici per dissezione

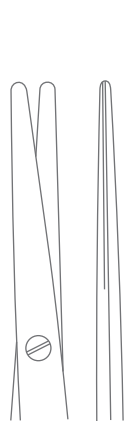

EI-904-18 SC
18 cm (7")

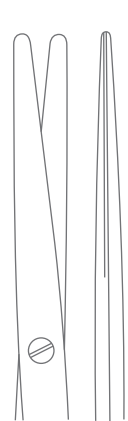

EI-904-20 SC
20.5 cm (8")

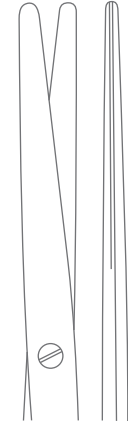

EI-904-23 SC
23 cm (9")

XTScut™

XTScut™ Metzenbaum-Nelson Dissecting Scissor
Straight, Blunt/Blunt

Dissecting Scissors
 Präparierscheren
 Tijeras de disección
 Ciseaux à dissection
 Forbici per dissezione



UltraCut™ Metzenbaum-Nelson Dissecting Scissor
 Curved, Blunt/Blunt

ULTRA.Cut™



EI-905-18
 18 cm (7")



EI-905-20
 20.5 cm (8")

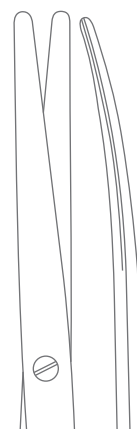

EI-905-23
 23 cm (9")



EI-905-25
 26 cm (10 1/4")

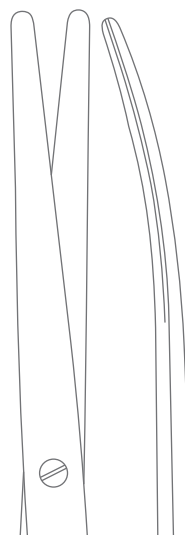

EI-905-28
 28.5 cm (11 1/4")

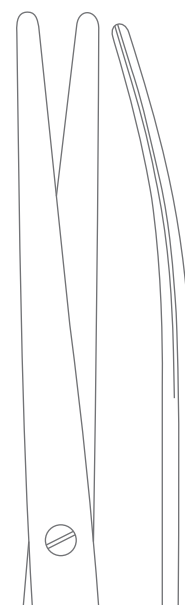

EI-905-30
 31 cm (12 1/4")

Dissecting Scissors
Präparierscheren
Tijeras de disección
Ciseaux à dissection
Forbici per dissezione

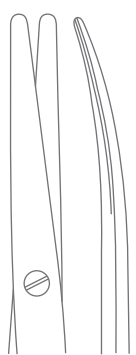
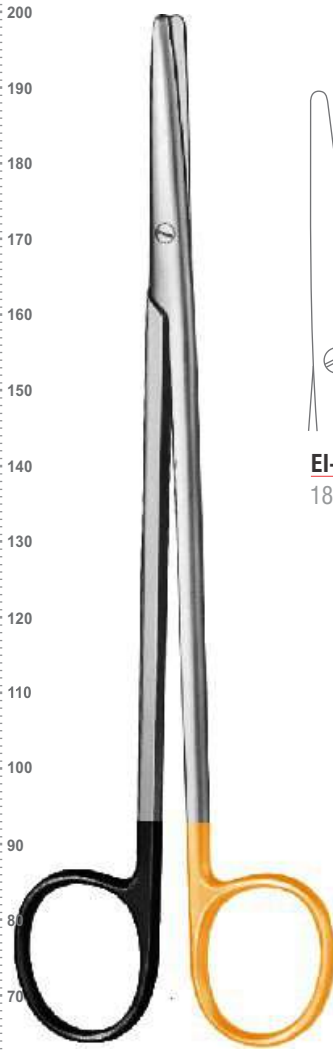

EI-905-18 SC
18 cm (7")



EI-905-20 SC
20.5 cm (8")



EI-905-23 SC
23 cm (9")

XTS-Cut™

XTSCut™ Metzenbaum-Nelson Dissecting Scissor
Curved, Blunt/Blunt

Dissecting Scissors
Präparierscheren
Tijeras de disección
Ciseaux à dissection
Forbici per dissezione



UltraCut™ TC Metzenbaum -Thorek Dissecting Scissor
Curved



EI-907-20
20 cm (8")

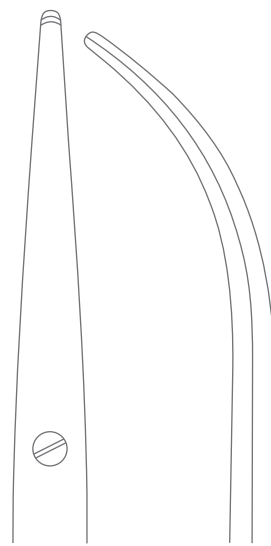

EI-907-23
23 cm (9")

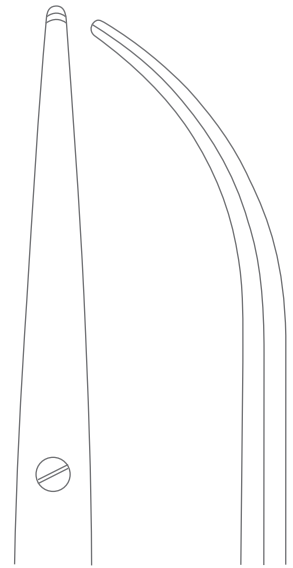

EI-907-28
28 cm (11")

ULTRA *Cut*™

Dissecting Scissors
 Präparierscheren
 Tijeras de disección
 Ciseaux à dissection
 Forbici per dissezione

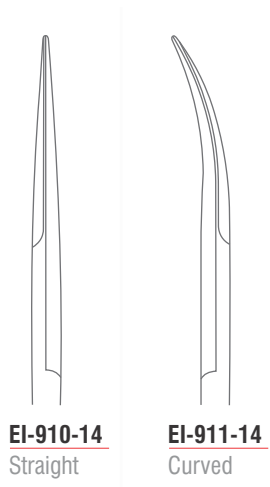

EI-910-14
Straight

EI-911-14
Curved

ULTRA *Cut*™

UltraCut™ TC Joseph Dissecting Scissor
 Overall Length 14.5 cm (5 3/4")

Dissecting Scissors
Präparierscheren
Tijeras de disección
Ciseaux à dissection
Forbici per dissezione

EVA

SCISSORS

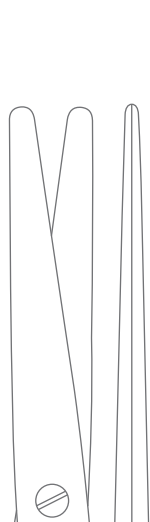

EI-914-16
Straight
16 cm (6 ¼")

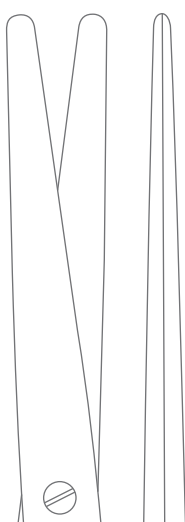

EI-914-21
Straight
21 cm (8 ¼")

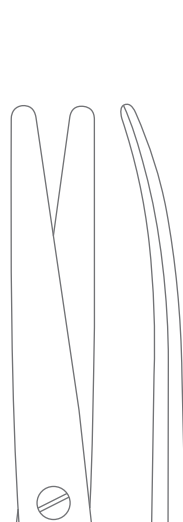

EI-915-16
Curved
16 cm (6 ¼")



EI-915-21
Curved
21 cm (8 ¼")

ULTRA.Cut™

UltraCut™ TC Lexer Dissecting Scissor

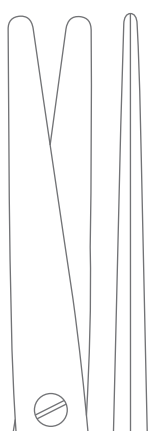
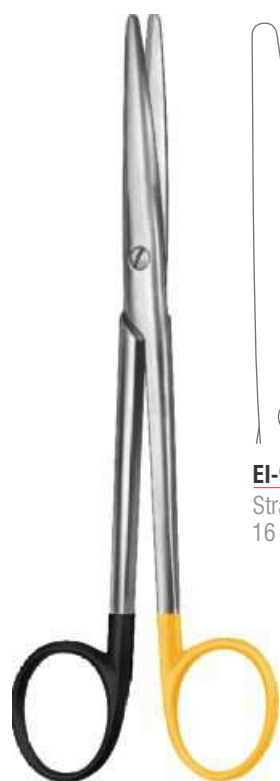

EI-914-16 SC
Straight
16 cm (6 ¼")



EI-915-16 SC
Curved
16 cm (6 ¼")

XTS.Cut™

XTSCut™ TC Lexer Dissecting Scissor

Dissecting Scissors
 Präparierscheren
 Tijeras de disección
 Ciseaux à dissection
 Forbici per dissezione

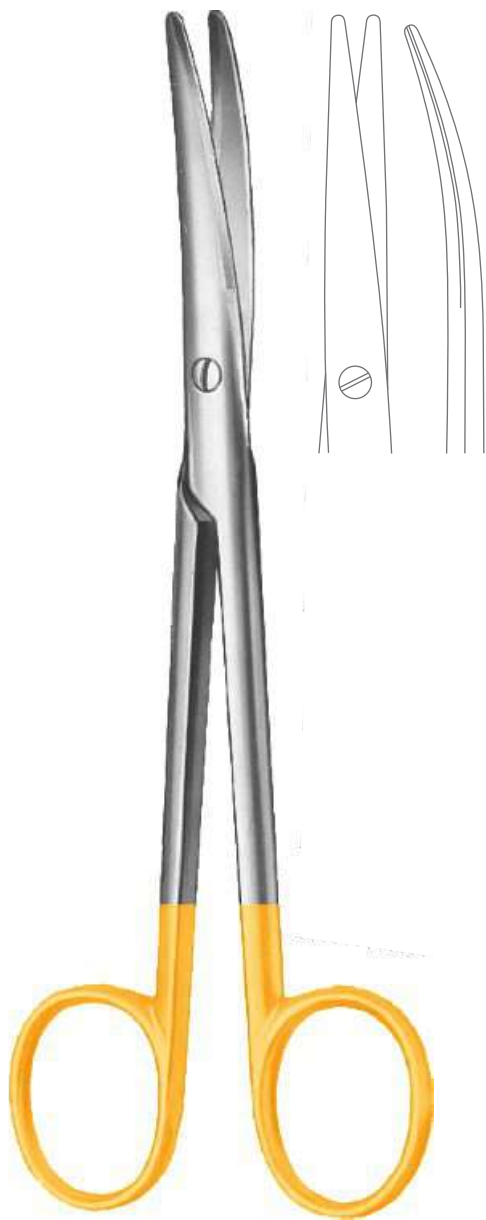

EI-917-16
UltraCut™ TC Mayo-Lexer Dissecting Scissor
 Curved
 Overall Length 16 cm (6 1/4")

ULTRA.Cut™

Dissecting Scissors
 Präparierscheren
 Tijeras de disección
 Ciseaux à dissection
 Forbici per dissezione

EVA

SCISSORS



EI-920-14
Straight

EI-921-14
Curved

ULTRACut™

UltraCut™ TC Metzenbaum-Fine Delicate Dissecting Scissor
 Slender Pattern
 Overall Length 14.5 cm (5 ¾")



EI-920-14 SC
Straight

EI-921-14 SC
Curved

XTScut™

XTSCut™ TC Metzenbaum-Fine Delicate Dissecting Scissor
 Slender Pattern
 Overall Length 14.5 cm (5 ¾")

Dissecting Scissors
Präparierscheren
Tijeras de disección
Ciseaux à dissection
Forbici per dissezione

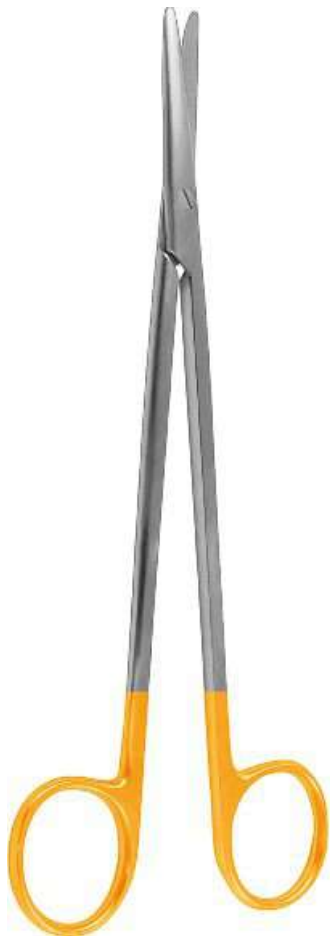

UltraCut™ TC Metzenbaum-Fine Delicate Dissecting Scissor
Slender Pattern

ULTRA *Cut*™

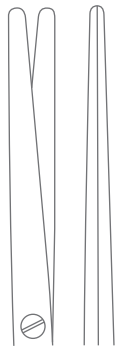

EI-922-18
Straight
18 cm (7")

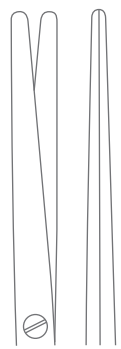

EI-922-20
Straight
20.5 cm (8")

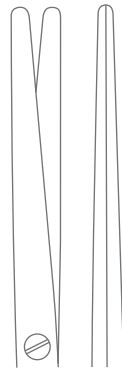

EI-922-23
Straight
23 cm (9")

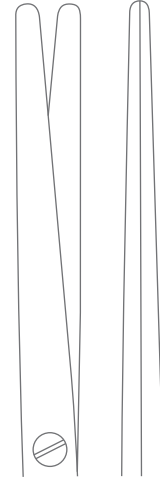

EI-922-25
Straight
25 cm (9 3/4")

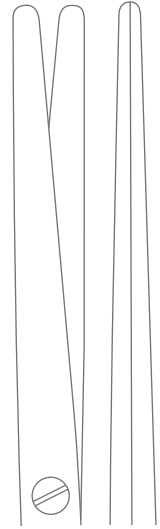

EI-922-28
Straight
28 cm (11")



EI-923-18
Curved
18 cm (7")



EI-923-20
Curved
20.5 cm (8")

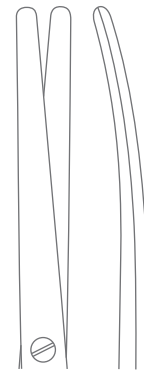

EI-923-23
Curved
23 cm (9")



EI-923-25
Curved
25 cm (9 3/4")

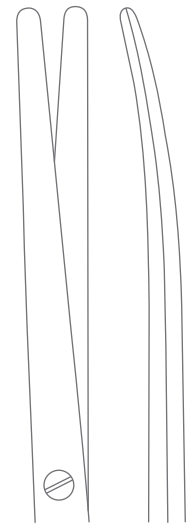

EI-923-28
Curved
28.5 cm (11 1/4")

Dissecting Scissors
 Präparierscheren
 Tijeras de disección
 Ciseaux à dissection
 Forbici per dissezione

EVA

SCISSORS

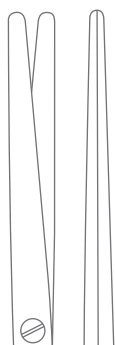
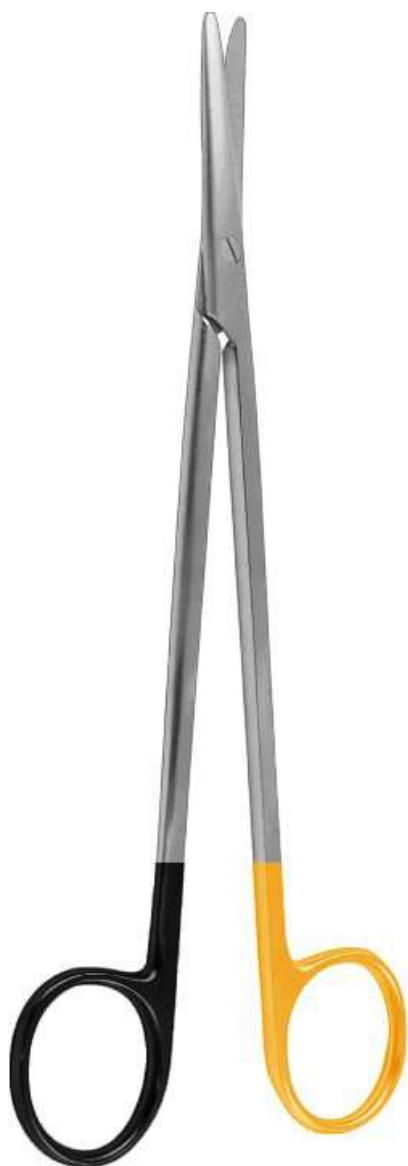

EI-922-18 SC
 Straight
 18 cm (7")

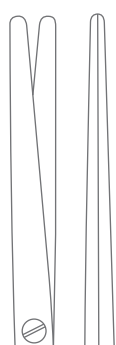

EI-922-20 SC
 Straight
 20.5 cm (8")

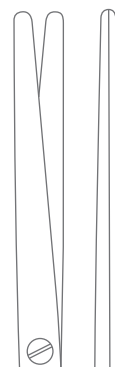

EI-922-23 SC
 Straight
 23 cm (9")



EI-923-18 SC
 Curved
 18 cm (7")



EI-923-20 SC
 Curved
 20.5 cm (8")



EI-923-23 SC
 Curved
 23 cm (9")

XTSCut™ TC Metzenbaum-Fine Delicate Dissecting Scissor
 Slender Pattern

XTSCut

Dissecting Scissors
Präparierscheren
Tijeras de disección
Ciseaux à dissection
Forbici per dissezione



EI-926-14
Straight



EI-927-14
Curved

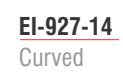

UltraCut™ TC Metzenbaum-Fine Delicate Dissecting Scissor
Overall Length 14.5 cm (5 3/4")

ULTRA *Cut*



EI-928-18
Straight

EI-928-20
Straight



UltraCut™ TC Metzenbaum-Fine Delicate Dissecting Scissor
Straight

ULTRA *Cut*

Dissecting Scissors
Präparierscheren
Tijeras de disección
Ciseaux à dissection
Forbici per dissezione

EVA

SCISSORS

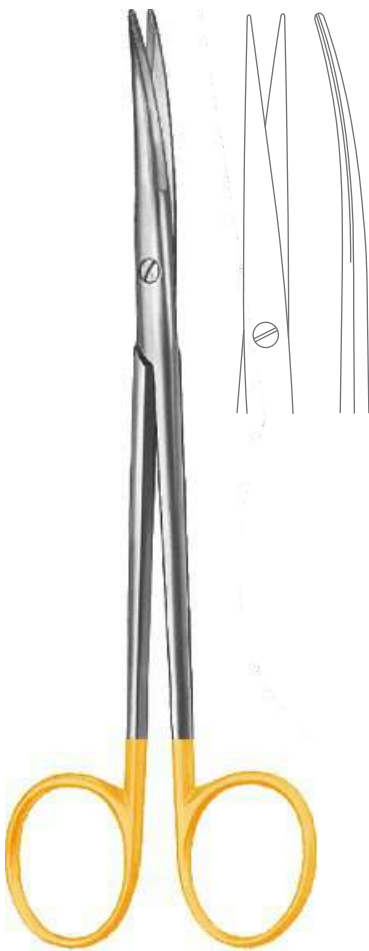

EI-931-14

UltraCut™ TC Metzenbaum-Lahey Dissecting Scissor
Curved
Overall Length 14.5 cm (5 ¾")

ULTRA *Cut*™



EI-933-17

UltraCut™ TC Toennis-Adson Dissecting Scissor
Curved, Slender Pattern
Overall Length 17.5 cm (7")

ULTRA *Cut*™

Dissecting Scissors
Präparierscheren
Tijeras de disección
Ciseaux à dissection
Forbici per dissezione



EI-935-20
Curved
20.5 cm 8"

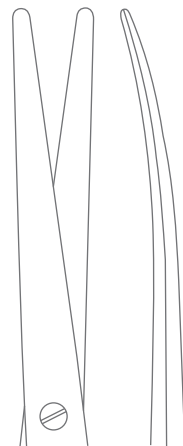

EI-935-23
Curved
23.5 cm 9"

ULTRA *Cut*™

UltraCut™ TC Metzenbaum-Lahey Dissecting Scissor
Slender Pattern

Dissecting Scissors
Präparierscheren
Tijeras de disección
Ciseaux à dissection
Forbici per dissezione

EVA

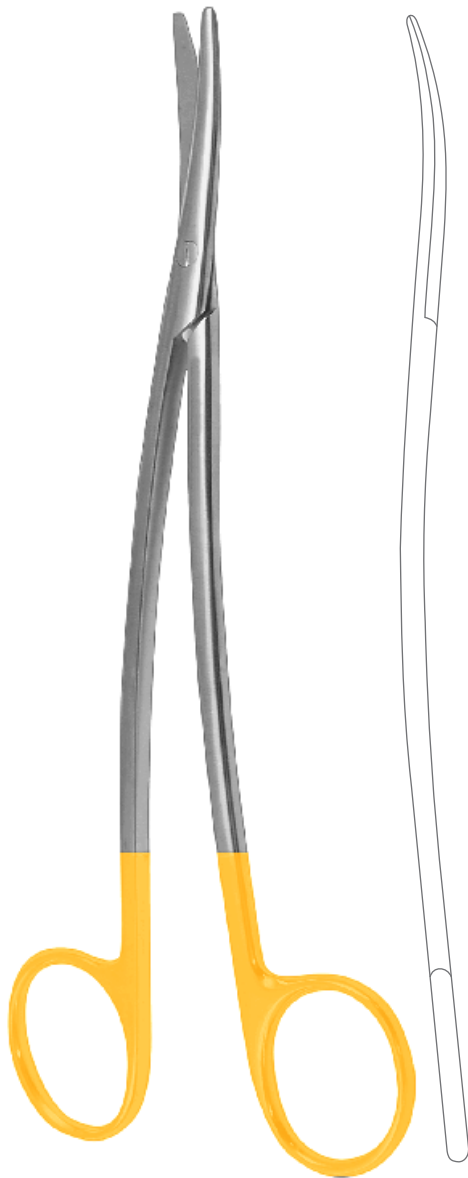

ULTRACut™

UltraCut™ TC Metzenbaum-Fine Dissecting Scissor
Curved, S Shaped, Slender Pattern

Nasal Scissors
Nasenscheren
Tijeras nasals
Ciseaux nasaux
Forbici nasali



EI-939-15
UltraCut™ TC Fomon Nasal Scissor
Overall Length 14.5 cm (5 ¾")

ULTRA.Cut™

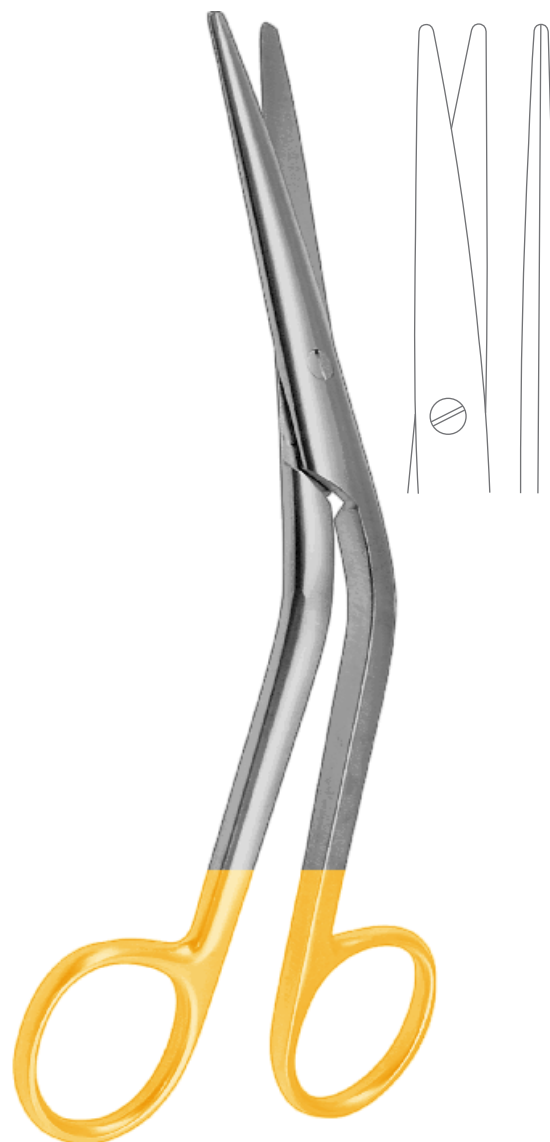

EI-941-16
UltraCut™ TC Cottle Nasal Scissor
Overall Length 16 cm (6 ¼")

ULTRA.Cut™

Face-lift Scissors
Face-lift-Scheren
Tijeras para Face-Lift
Ciseaux pour Face-lift
Forbici per Face-lift

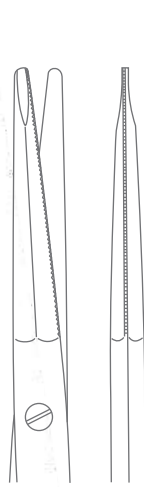

EI-944-20
20 cm (8")

UltraCut™ TC Gorney Face-Lift Scissor
Straight, One Toothed Cutting Edge

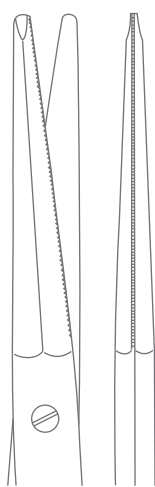

EI-944-23
23 cm (9")

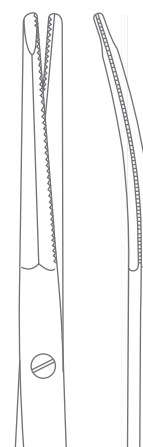

EI-947-17
UltraCut™ TC Rees Face-Lift Scissor
Curved, One Toothed Cutting Edge
Overall Length 17 cm (6 3/4")





Face-lift Scissors
Face-lift-Scheren
Tijeras para Face-Lift
Ciseaux pour Face-lift
Forbici per Face-lift

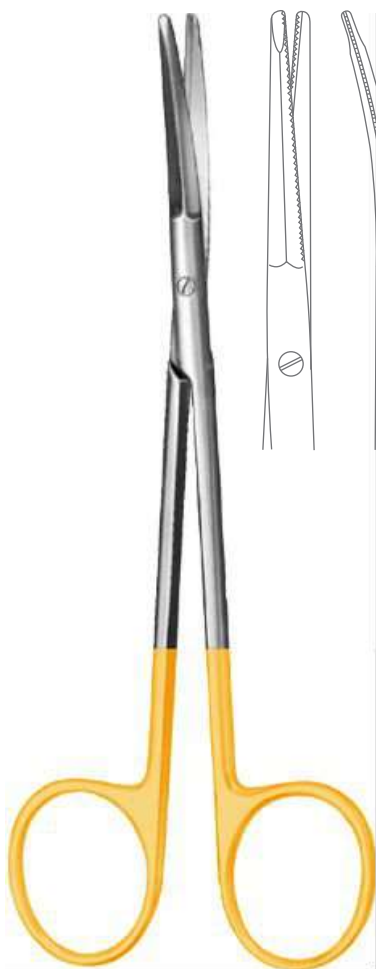

EI-949-14
UltraCut™ TC Gregory Face-Lift Scissor
One Toothed Cutting Edge
Overall Length 14 cm (5 1/2")

ULTRACut™



EI-951-15
15 cm (6")

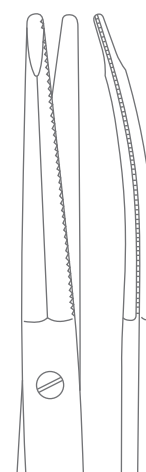

EI-951-18
18 cm (7")

UltraCut™ TC Kaye Face-Lift Scissor
One Toothed Cutting Edge

ULTRACut™

Face-lift Scissors
Face-lift-Scheren
Tijeras para Face-Lift
Ciseaux pour Face-lift
Forbici per Face-lift

EVA



EI-953-18
UltraCut™ TC Stella-S Face-Lift Scissor
S Shaped, One Toothed Cutting Edge
Overall Length 18 cm (7")

ULTRACut™



EI-959-18
UltraCut™ TC Stella-S Face-Lift Scissor
One Toothed Cutting Edge
Overall Length 18 cm (7")

ULTRACut™

Face-lift Scissors
Face-lift-Scheren
Tijeras para Face-Lift
Ciseaux pour Face-lift
Forbici per Face-lift



EI-961-18
UltraCut™ TC Freeman-Kaye Face-Lift Scissor
One Toothed Cutting Edge
Overall Length 18 cm (7")

ULTRA *Cut*™

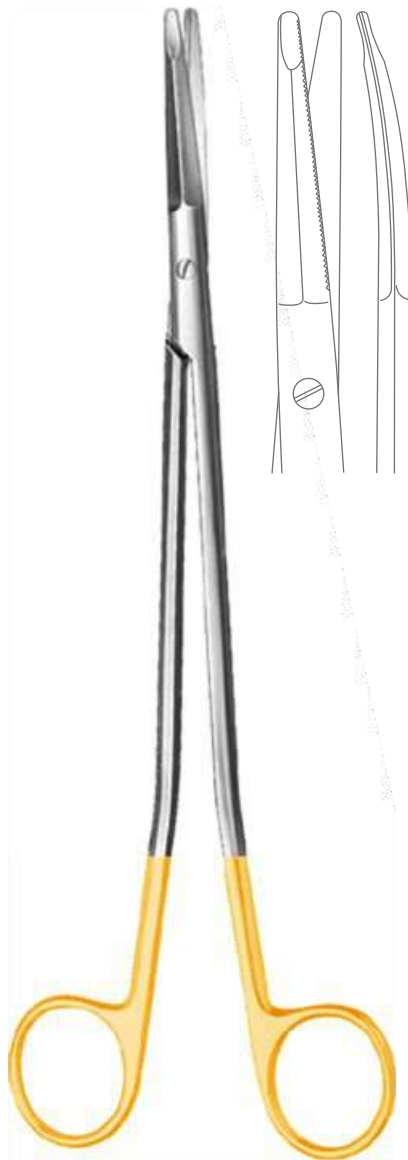

EI-963-23
UltraCut™ TC Freeman-Kaye Face-Lift Scissor
One Toothed Cutting Edge
Overall Length 23 cm (9")

ULTRA *Cut*™

Gynecological Scissors
Gynäkologische Scheren
Tijeras para ginecología
Ciseaux à gynécologie
Forbici per ginecologia

EVA



UltraCut™ TC Wertheim Gynecological Scissor
Curved

ULTRA.Cut™



EI-965-23
23 cm (9")



EI-965-35
35 cm (14")



EI-968-23
Systrunk Nail Splitting Scissor
Straight
Overall Length 23 cm (9")

ULTRA.Cut™

Hysterectomy Scissors
Hysterektomiescheren
Tijeras para histerectomía
Ciseaux à hystérectomie
Forbici per isterectomia



EI-969-23
UltraCut™ TC Sims Uterine Scissor
Curved
Overall Length 23 cm (9")

ULTRA *Cut*™



UltraCut™ TC Parametrium Hysterectomy Scissor

ULTRA *Cut*™

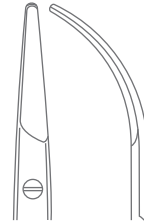

EI-971-01
Strongly Curved



EI-971-02
Curved

EI-971-03
Slightly Curved

EI-971-04
Strongly Curved

EI-971-05
Medium Curved

EI-971-06
Slightly Curved

EI-971-07
Medium Curved

EI-971-08
Slightly Curved

Ophthalmology Instruments
 Ophthalmologie Instrumente
 Oftalmología Instrumentos
 Ophtalmologie Instruments
 Oftalmologia Strumenti

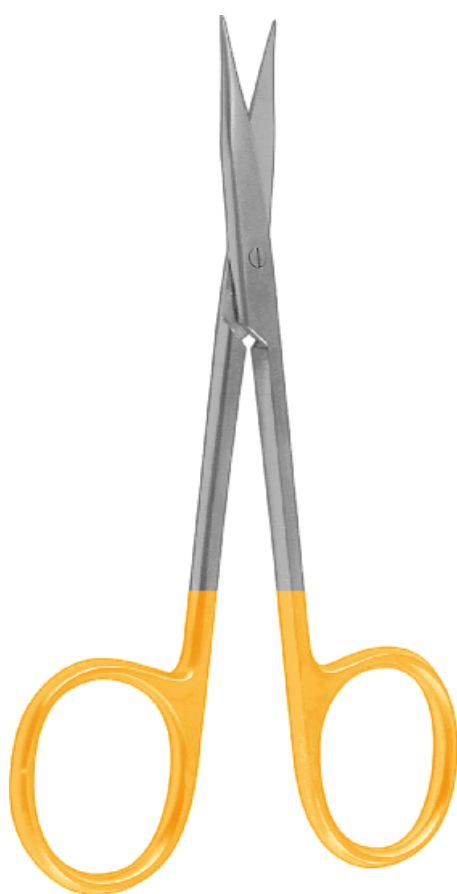

UltraCut™ TC Stevens Tenotomy Scissor

ULTRA *Cut*™



EI-972-10
 Straight
 Blunt/Blunt
 10.5 cm (4 1/4")

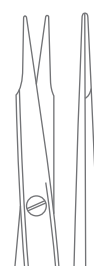

EI-972-11
 Straight
 Blunt/Blunt
 11.5 cm (4 1/2")



EI-973-10
 Curved
 Blunt/Blunt
 10.5 cm (4 1/4")



EI-973-11
 Curved
 Blunt/Blunt
 11.5 cm (4 1/2")



EI-974-10
 Straight
 Sharp/Sharp
 10.5 cm (4 1/4")

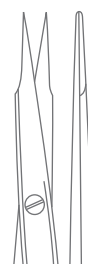

EI-974-11
 Straight
 Sharp/Sharp
 11.5 cm (4 1/2")



EI-9EI-10
 Curved
 Sharp/Sharp
 10.5 cm (4 1/4")



EI-9EI-11
 Curved
 Sharp/Sharp
 11.5 cm (4 1/2")

Gum Scissors
Zahnfleischscheren
Tijeras para encías
Ciseaux à gencives
Forbici per gengiva



UltraCut™ Goldman-Fox Gum Scissor
One Toothed Cutting Edge
Overall Length 13 cm (5")

ULTRA *Cut*™

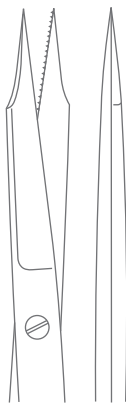

EI-976-13
Straight



EI-9EI-13
Curved



XTSCut™ TC Goldman-Fox Gum Scissor
One Toothed Cutting Edge
Overall Length 13 cm (5")

XTS *cut*™



EI-976-13
Straight



EI-9EI-13
Curved

Iris Scissors
 Irisscheren
 Tijeras para iridectomía
 Ciseaux à iridectomie
 Forbici per iridectomia



EI-978-11
Straight

EI-979-11
Curved

ULTRA *Cut*[™]

UltraCut™ TC Iris Scissor
 Overall Length 11.5 cm (4 ½")

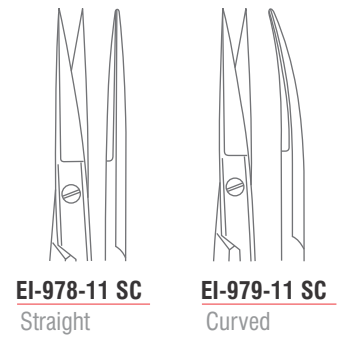

EI-978-11 SC
Straight

EI-979-11 SC
Curved

XTS *cut*

XTSCut™ TC Iris Scissor
 Overall Length 11.5 cm (4 ½")

Vascular Scissors
Gefäßscheren
Tijeras vasculares
Ciseaux vasculaires
Forbici vascolari



UltraCut™ TC DeBakey Vascular Scissor

ULTRA.Cut™

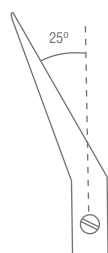

EI-981-25
Angled 25°
19 cm (7 1/2")

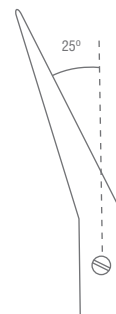

EI-983-25
Angled 25°
23 cm (9")

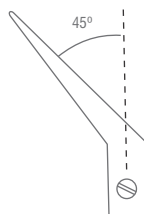

EI-981-45
Angled 45°
18.5 cm (7 1/4")

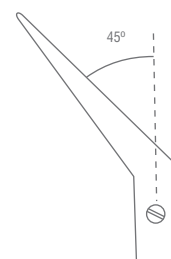

EI-983-45
Angled 45°
23 cm (9")

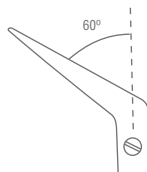

EI-981-60
Angled 60°
18 cm (7")

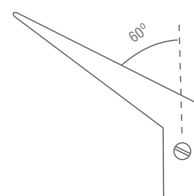

EI-983-60
Angled 60°
22 cm (8 3/4")

Iris Scissors, Dissecting Scissors
 Irisscheren, Präparierscheren
 Tijeras para iridectomía, Tijeras de disección
 Ciseaux à iridectomie, Ciseaux à dissection
 Forbici per iridectomia, Forbici per dissezione

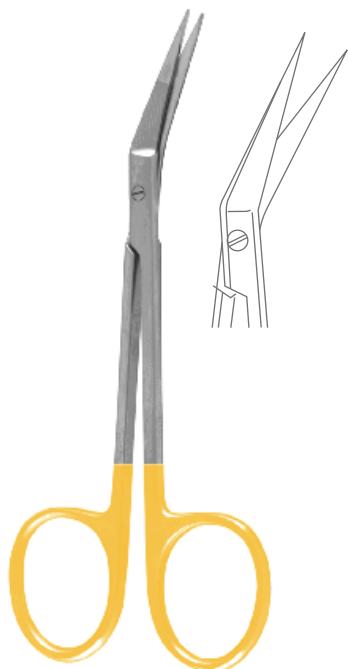

EI-985-11
UltraCut™ TC Iris Scissor
 Angled
 Overall Length 11 cm (4 1/2")

ULTRA *Cut*™



EI-987-12
 12.5 cm (5")



EI-987-15
 15 cm (6")

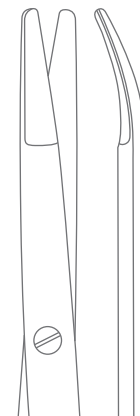

EI-987-18
 18 cm (7")

UltraCut™ TC Ragnell (Kilner) Dissecting Scissor
 Curved

ULTRA *Cut*™

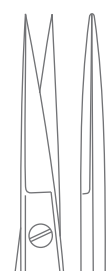

EI-988-16
 Straight

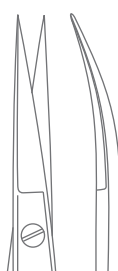

EI-989-16
 Curved

ULTRA *Cut*™

UltraCut™ TC Kelly Dissecting Scissor
 Overall Length 16 cm (6 1/4")

EVA

Wire Cutting Scissors
Drahtscheren
Tijeras para cortar hilos de acero
Ciseaux coupe-fil
Forbici per tagliare fili metallic

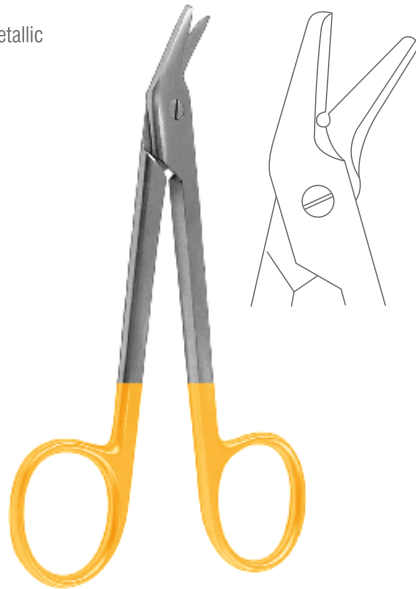

EI-991-12
UltraCut™ TC Universal Wire Cutting Scissor
Angled One Toothed Cutting Edge
Overall Length 12.5 cm (5")

ULTRA *Cut*™



EI-992-16
UltraCut™ TC Smith Wire Cutting Scissor
Angled One Toothed Cutting Edge
Overall Length 16 cm (6 1/4")

ULTRA *Cut*™



EI-993-17
UltraCut™ TC Dean Tonsil Scissor
S Shaped, Angled Upwards
Overall Length 17.5 cm (7")

Wire Cutting Scissors
Drahtscheren
Tijeras para cortar hilos de acero
Ciseaux coupe-fil
Forbici per tagliare fili metallic

EVA

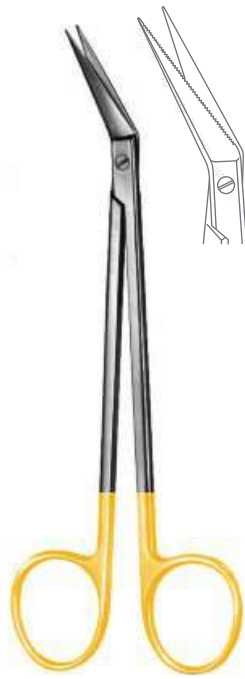

EI-993-17
UltraCut™ TC Locklin Gum Scissor
Angled, One Toothed Cutting Edge
Overall Length 17.5 cm (7")

ULTRA.Cut™

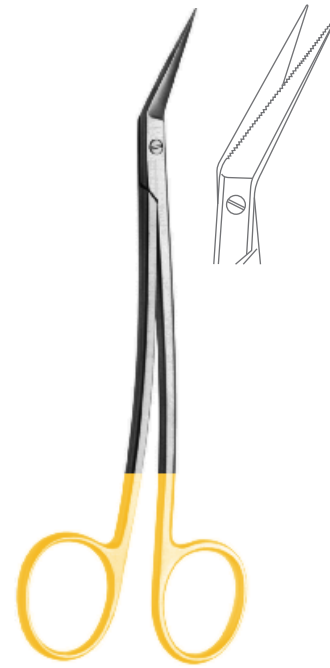

EI-495-16
UltraCut™ TC Locklin Gum Scissor
Angled, S Shaped One Toothed Cutting Edge
Overall Length 16 cm (6 ¼")

ULTRA.Cut™













EI-999-18
UltraCut™ TC Lister Bandage Scissor
Overall Length 18 cm (7")

ULTRA.Cut™









Dissecting Forceps
Anatomische Pinzetten
Pinzas de disección
Pinces à dissection
Pinze per dissezione



				
EI-010-10 10.5 cm (4 1/4")	EI-010-11 11.5 cm (4 1/2")	EI-010-13 13 cm (5")	EI-010-14 14.5 cm (5 3/4")	EI-010-16 16 cm (6 1/4")
				
EI-010-18 18 cm (7")	EI-010-20 20 cm (8")	EI-010-23 23 cm (9")	EI-010-25 25 cm (9 3/4")	EI-010-30 30.5 cm (12")

Standard Pattern Dressing Forcep
Straight, Serrated



				
EI-012-11 12 cm (4 3/4")	EI-012-13 13 cm (5")	EI-012-14 14.5 cm (5 3/4")	EI-012-16 16 cm (6 1/4")	EI-012-18 18 cm (7")
				
EI-012-20 20 cm (8")	EI-012-23 23 cm (9")	EI-012-25 25 cm (9 3/4")	EI-012-30 30 cm (11 3/4")	

Slender Pattern Dressing Forcep
Straight, Serrated

Dissecting Forceps
Anatomische Pinzetten
Pinzas de disección
Pincès à dissection
Pinze per dissezione



EI-013-13
13 cm (5")



EI-013-14
14 cm (5 1/2")



EI-013-16
16 cm (6 1/4")

Slender Pattern Dressing Forcep
Curved, Serrated



EI-016-13
13 cm (5")



EI-016-14
14.5 cm (5 3/4")



EI-016-16
16 cm (6 1/4")



EI-016-18
18 cm (7")



EI-016-20
20 cm (8")

Fine Pattern Dressing Forcep
Straight, Serrated

Dissecting Forceps
Anatomische Pinzetten
Pinzas de disección
Pincès à dissection
Pinze per dissezione



EI-030-15
Stille Dressing Forcep
Round Tips
Overall Length 15 cm (6")



Stille Dressing Forcep
Square Tips



EI-035-15
15 cm (6")



EI-035-17
17 cm (6 3/4")



EI-035-20
20 cm (8")

Dissecting Forceps
Anatomische Pinzetten
Pinzas de disección
Pincès à dissection
Pinze per dissezione

EVA



EI-040-15
Treves Dressing Forcep
Overall Length 15 cm (6")



Adson Dressing Forcep



EI-050-12
12 cm (4 3/4")

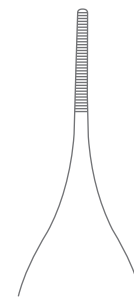

EI-050-15
15 cm (6")

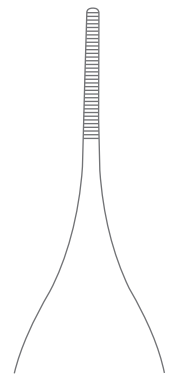

EI-050-18
18 cm (7")

Dissecting Forceps
Anatomische Pinzetten
Pinzas de disección
Pincès à dissection
Pinze per dissezione



EI-051-12
Adson Dressing Forcep
Curved
Overall Length 12 cm (4 3/4")



EI-052-12
Mini Adson Dressing Forcep
Cross Serrated Tips
Overall Length 12 cm (4 3/4")

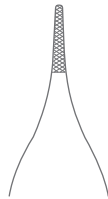

Micro Adson Dressing Forcep



EI-054-12
12 cm (4 3/4")

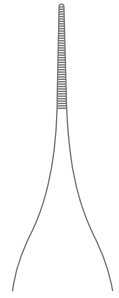

EI-054-15
15 cm (6")



Dissecting Forceps
Anatomische Pinzetten
Pinzas de disección
Pinces à dissection
Pinze per dissezione

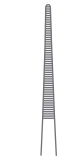

EI-080-06
0.6 mm



EI-080-08
0.8 mm



EI-080-10
1.0 mm

EI-078-17
Taylor Dressing Forcep
Bayonet Shaped, With Dissector End
Overall Length 18.5 cm (7 1/4")

Turner Micro Dressing Forcep
Overall Length 15.5 cm (6")

Dissecting Forceps
Anatomische Pinzetten
Pinzas de disección
Pinces à dissection
Pinze per dissezione

EVA



EI-084-17
17.5 cm (7")

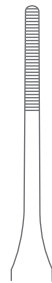

EI-084-23
23 cm (9")



EI-085-17
Gerald Dressing Forcep
Curved
Overall Length 17.5 cm (7")

Dissecting Forceps
Anatomische Pinzetten
Pinzas de disección
Pincès à dissection
Pinze per dissezione



Cushing Dressing Forcep
Straight

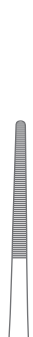

EI-090-17
17.5 cm (7")



EI-090-20
20 cm (8")



EI-090-25
25 cm (9 3/4")



EI-091-17
Cushing Dressing Forcep
Curved
Overall Length 17.5 cm (7")

Dissecting Forceps
Anatomische Pinzetten
Pinzas de disección
Pinces à dissection
Pinze per dissezione

EVA



Potts-Smith Dressing Forcep



EI-094-18
18 cm (7")



EI-094-21
21 cm (8 1/4")



EI-094-25
24.5 (9 3/4")



EI-094-30
30 cm (11 3/4")



EI-096-15
Dressing Forcep
Overall Length 15.5 cm (6")



Dissecting Forceps
Anatomische Pinzetten
Pinzas de disección
Pinces à dissection
Pinze per dissezione



EI-100-15
Gillies Dressing Forcep
Overall Length 15 cm (6")



EI-102-20
Waugh Dressing Forcep
Cross Serrated
Overall Length 20 cm (8")

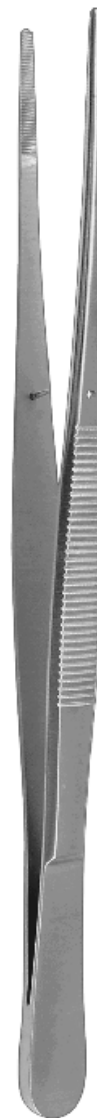

Brophy Dressing Forcep
Overall Length 20 cm (8")



EI-104-20
Straight

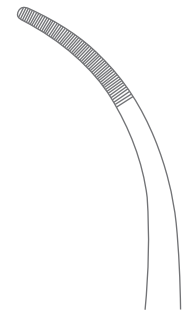

EI-105-20
Curved

Dissecting Forceps
Anatomische Pinzetten
Pinzas de disección
Pinces à dissection
Pinze per dissezione

EVA

FORCEPS



EI-108-20
Cooley Dressing Forcep
Cross Serrated Jaws
Overall Length 20 cm (8")



EI-111-20
Dressing Forcep
Angled
Overall Length 20 cm (8")



EI-112-13
Fricke Ligature Forcep
With Lock
Overall Length 13 cm (5")

Dissecting Forceps
Anatomische Pinzetten
Pinzas de disección
Pincès à dissection
Pinze per dissezione



EI-114-14
Ochsner Dressing Forcep
Longitudinal Serrations
Overall Length 14.5 cm (5 3/4")



EI-116-17
Bonney Dressing Forcep
Overall Length 17.5 cm (7")



EI-118-18
Ramsey Dressing Forcep
Overall Length 18 cm (7")

Dissecting Forceps
Anatomische Pinzetten
Pinzas de disección
Pincès à dissection
Pinze per dissezione



- | | | | | |
|--------------------------------------|--------------------------------------|--------------------------------|--------------------------------------|------------------------------------|
| | | | | |
| EI-200-10
10.5 cm (4 1/4") | EI-200-11
11.5 cm (4 1/2") | EI-200-13
13 cm (5") | EI-200-14
14.5 cm (5 3/4") | EI-200-16
16 cm (6 1/4") |
| | | | | |
| EI-200-18
18 cm (7") | EI-200-20
20 cm (8") | EI-200-23
23 cm (9") | EI-200-25
25 cm (9 3/4") | EI-200-30
30.5 cm (12") |

Slender Pattern Dissecting Forcep
Straight, 1 x 2 Teeth



- | | | | |
|------------------------------------|--------------------------------|--------------------------------------|----------------------------------|
| | | | |
| EI-202-11
12 cm (4 3/4") | EI-202-13
13 cm (5") | EI-202-14
14.5 cm (5 3/4") | EI-202-16
15.5 cm (6") |
| | | | |
| EI-202-18
18 cm (7") | EI-202-20
20 cm (8") | EI-202-25
24.5 cm (9 3/4") | |

Slender Pattern Dissecting Forcep
Straight, 2 x 3 Teeth



Dissecting Forceps
Anatomische Pinzetten
Pinzas de disección
Pinces à dissection
Pinze per dissezione



EI-204-14
14.5 cm (5 3/4")

EI-204-16
16 cm (6 1/4")



3:4

Standard Pattern Dissecting Forcep
Straight, 3 x 4 Teeth



EI-206-14
14.5 cm (5 3/4")

EI-206-16
16 cm (6 1/4")



4:5

Standard Pattern Dissecting Forcep
Straight, 4 x 5 Teeth

Dissecting Forceps
Anatomische Pinzetten
Pinzas de disección
Pinces à dissection
Pinze per dissezione

EI-210-13
13 cm (5")



EI-210-14
14.5 cm (5 3/4")



EI-210-16
16 cm (6 1/4")



EI-210-18
18 cm (7")



EI-210-20
20 cm (8")



EI-210-25
25 cm (9 3/4")



EI-210-30
30.5 cm (12")

Slender Pattern Dissecting Forcep
Straight, 1 x 2 Teeth



EI-211-14
14.5 cm (5 3/4")



EI-211-16
16 cm (6 1/4")

EI-214-13
13 cm (5")



EI-214-14
14.5 cm (5 3/4")



EI-214-16
16 cm (6 1/4")



EI-214-18
18 cm (7")

Slender Pattern Dissecting Forcep
Curved, 1 x 2 Teeth



Fine Pattern Dissecting Forcep
Straight, 1 x 2 Teeth



Dissecting Forceps
Anatomische Pinzetten
Pinzas de disección
Pincès à dissection
Pinze per dissezione

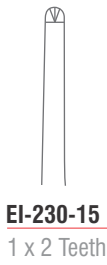

EI-230-15
1 x 2 Teeth

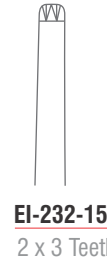

EI-232-15
2 x 3 Teeth



EI-234-15
Stone Dissecting Forcep
Overall Length 15 cm (5 3/4")



EI-236-15
Lerche Dissecting Forcep
Overall Length 15 cm (6")



1:2



4:5



5:6

Dissecting Forceps
 Anatomische Pinzetten
 Pinzas de disección
 Pinces à dissection
 Pinze per dissezione

EVA

FORCEPS



EI-240-15
 15.5 cm (6")



EI-240-20
 20.5 cm (8")



EI-242-15
 16 cm (6 1/4")



EI-242-20
 20 cm (8")

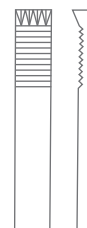

EI-242-25
 25 cm (9 3/4")

Adlerkreutz Dissecting Forcep
 2 x 3 Teeth



Adlerkreutz Dissecting Forcep
 4 x 5 Teeth



Dissecting Forceps
Anatomische Pinzetten
Pinzas de disección
Pincas à dissection
Pinze per dissezione



Adson Dissecting Forcep
1 x 2 Teeth

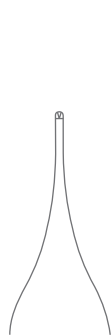

EI-250-12
12 cm (4 3/4")

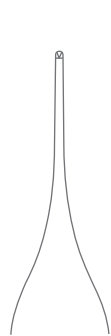

EI-250-15
15 cm (6")

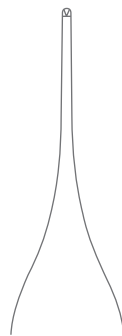

EI-250-18
18 cm (7")



Mini-Adson Dissecting Forcep
1 x 2 Teeth, Cross Serrated
Overall Length 15 cm (6")



EI-252-12
12 cm (4 3/4")



EI-253-12
12 cm (4 3/4")

Dissecting Forceps
Anatomische Pinzetten
Pinzas de disección
Pinces à dissection
Pinze per dissezione

EVA

FORCEPS



EI-256-12
12 cm (4 3/4")

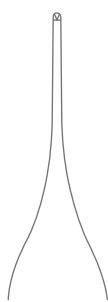

EI-256-15
15 cm (6")

Micro-Adson Dissecting Forcep
1 x 2 Teeth

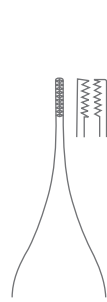

EI-258-12
12 cm (5")

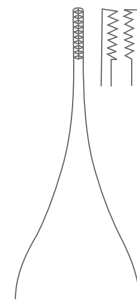

EI-258-15
15 cm (6")

Adson-Brown Dissecting Forcep
7 x 7 Teeth



Dissecting Forceps
Anatomische Pinzetten
Pinzas de disección
Pincès à dissection
Pinze per dissezione



EI-260-12
Adson-Brown Dissecting Forcep
9 x 9 Teeth
Overall Length 12 cm (5")



Brown Dissecting Forcep
7 x 7 Teeth

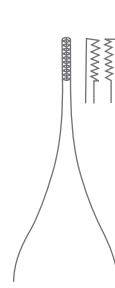

EI-260-15
15.5 cm (6 1/4")

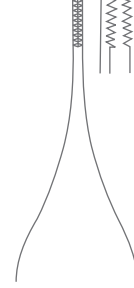

EI-260-20
20 cm (7")

Dissecting Forceps
 Anatomische Pinzetten
 Pinzas de disección
 Pinces à dissection
 Pinze per dissezione

EVA

FORCEPS

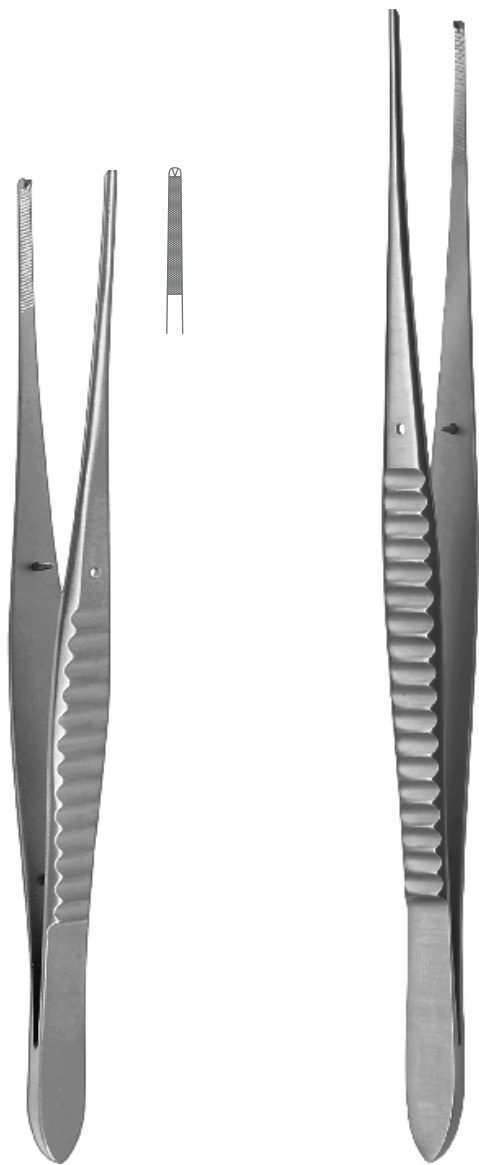

EI-270-15
Gillies Dissecting Forcep
 1 x 2 Teeth, Cross Serrated
 Overall Length 15.5 cm (6")



Waugh Dissecting Forcep
 1 x 2 Teeth, Cross Serrated



EI-272-18
 18 cm (7")

EI-272-20
 20.5 cm (8")

EI-272-25
 25 cm (10")

EI-272-30
 30.5 cm (12")

Dissecting Forceps
Anatomische Pinzetten
Pinzas de disección
Pinces à dissection
Pinze per dissezione



EI-274-12
12.5 cm (5")



EI-274-15
15.5 cm (6")



EI-280-17
Taylor Dissecting Forcep
1 x 2 Teeth
Overall Length 17.5 cm (7")



EI-282-17
Taylor Dissecting Forcep
1 x 2 Teeth, With Dissector End
Overall Length 17 cm (6 3/4")



Dissecting Forceps
Anatomische Pinzetten
Pinzas de disección
Pincès à dissection
Pinze per dissezione



EI-283-17
Taylor Dissecting Forcep
1 x 2 Teeth, Bayonet Shaped
Overall Length 18.5 cm (7 1/4")



1:2



EI-286-06
0.6 mm

EI-286-08
0.8 mm

EI-286-10
1.0 mm

Dissecting Forcep
1 x 2 Teeth
Overall Length 15.5 cm (6")



1:2

Dissecting Forceps
Anatomische Pinzetten
Pinzas de disección
Pinces à dissection
Pinze per dissezione



Gerald Dissecting Forcep
1 x 2 Teeth



EI-290-17
Straight
17.5 cm (7")



EI-290-23
Straight
23 cm (9")



EI-291-17
Curved
17.5 cm (7")



Cushing Dissecting Forcep
1 x 2 Teeth



EI-294-18
18 cm (7")



EI-294-21
21 cm (8 1/4")



EI-294-25
24 cm (9 1/2")

Dissecting Forceps
Anatomische Pinzetten
Pinzas de disección
Pinces à dissection
Pinze per dissezione

EVA

FORCEPS



Potts-Smith Dissecting Forcep
1 x 2 Teeth



1:2



EI-296-18
18 cm (7")



EI-296-21
21 cm (8 ¼")



EI-296-25
24 cm (9 ½")



EI-298-15
McIndoe Dissecting Forcep
1 x 2 Teeth
Overall Length 15 cm (6")



1:2



EI-300-20
Brophy Dissecting Forcep
1 x 2 Teeth
Overall Length 20 cm (8")



1:2

Dissecting Forceps
Anatomische Pinzetten
Pinzas de disección
Pinces à dissection
Pinze per dissezione



Bonner-Modell Dissecting Forcep

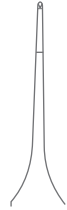

EI-302-09
1 x 2 Teeth
With Plateau
9.5 cm (3 ¾")

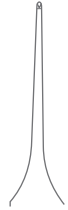

EI-302-09
1 x 2 Teeth
10.5 cm (4")



Micro Vessel Dilator
Overall Length 11 cm (4 ¼")



EI-305-02
Angled



EI-305-03
Angled



Micro Vessel Dilator



EI-306-13
Straight
13.5 cm (5 ½")



EI-306-18
Curved
18 cm (7")



EI-307-13
Straight
13.5 cm (5 ½")



EI-307-18
Curved
18 cm (7")

Jeweller Type Forceps
Uhrmacher-Pinzetten
Pinzas de relojero
Pinces d' horloger
Pinze da orologiaio

EVA

FORCEPS



EI-310-01
Jeweller Forcep
Fig. 1
Overall Length 12 cm (5")



EI-310-02
Jeweller Forcep
Fig. 2
Overall Length 12 cm (5")



EI-310-03
Jeweller Forcep
Fig. 3
Overall Length 12 cm (4 ¾")



EI-310-04
Jeweller Forcep
Fig. 4
Overall Length 11 cm (4 ¼")

Jeweller Type Forceps
Uhrmacher-Pinzetten
Pinzas de relojero
Pinces d`horloger
Pinze da orologiaio

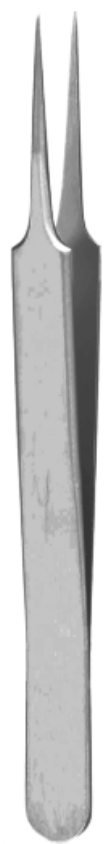

EI-310-05
Jeweller Forcep
Fig. 5
Overall Length 11 cm (4 1/4")



EI-310-07
Jeweller Forcep
Fig. 7
Overall Length 12 cm (4 3/4")



EI-310-13
Jeweller Forcep
Fig. 3C
Overall Length 11 cm (4 1/4")



EI-310-15
Jeweller Forcep
Fig. 5A
Overall Length 11 cm (4 1/4")

Jeweller Type Forceps
Uhrmacher-Pinzetten
Pinzas de relojero
Pincès d'horloger
Pinze da orologiaio

EVA

FORCEPS



EI-310-45
Jeweller Forcep
Fig. 5/45°
Overall Length 10.5 cm (4 1/4")



EI-310-90
Jeweller Forcep
Fig. 5/90°
Overall Length 10.5 cm (4 1/4")



EI-313-13
Jeweller Forcep
1 x 2 Teeth, 0.4 mm
Overall Length 11.5 cm (4 1/2")



Jeweller Type Forceps
Uhrmacher-Pinzetten
Pinzas de relojero
Pinces d`horloger
Pinze da orologiaio



EI-316-13
Jeweller Forcep
0.3 mm
Overall Length 13.5 cm (5 1/4")



EI-318-13
Jeweller Forcep
1 x 2 Teeth, 0.4 mm
Overall Length 13.5 cm (5 1/4")



EI-320-12
Jeweller Forcep
Straight, With Plateau, 0.3 mm
Overall Length 12 cm (3 3/4")

Jeweller Type Forceps, Micro Dilating Forceps
 Uhrmacher-Pinzetten, Gefäß-Dilatationspinzetten
 Pinzas de relojero, Micro pinza de dilatación
 Pinces d'horloger, Micro pince à dilater
 Pinze da orologiaio, Micro pinze per dilatazione

EVA

FORCEPS



EI-322-13
Straight



EI-323-13
Curved

Vise Micro Suturing Forcep
With Plateau, 0.3 mm
Overall Length 13.5 cm (5 1/4")



EI-325-00
Ø 0.20 mm
Angled

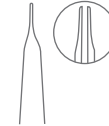

EI-325-01
Ø 0.30 mm
Angled

Micro Vessel Dilator
Overall Length 11 cm (4 1/4")



EI-325-02
Ø 0.30 mm
Angled

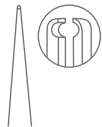

EI-325-12
Ø 0.20 mm
Angled

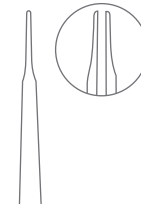

EI-325-13
Ø 0.30 mm
Angled

Micro Vessel Dilator
Overall Length 11 cm (4 1/4")

Micro Vessel Dilator
Overall Length 13 cm (5")

Micro Dilating Forceps
Gefäß-Dilatationspinzetten
Micro pinza de dilatación
Micro pince à dilater
Micro pinze per dilatazione



Micro Vessel Dilator
Overall Length 18 cm (7")



EI-325-42
Ø 0.20 mm
Angled

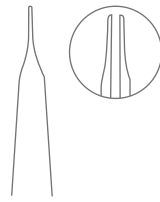

EI-325-43
Ø 0.30 mm
Angled



Micro Vessel Dilator
Overall Length 13 cm (5")



EI-327-00
Ø 0.20 mm

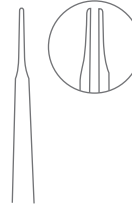

EI-327-01
Ø 0.30 mm

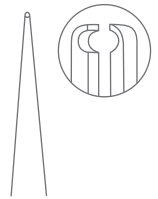

EI-327-02
Ø 0.30 mm
Micro Vessel Forcep

Micro Dilating Forceps, Tissue Forceps
 Gefäß-Dilatationspinzetten, Chirurgische Pinzetten
 Micro pinza de dilatación, Pinzas de disección con diente
 Micro pince à dilater, Pincès à dissection à griffes
 Micro pinze per dilatazione, Pinze per dissezione con denti

EVA

FORCEPS



EI-327-42
 Ø 0.20 mm
 Straight



EI-327-43
 Ø 0.30 mm
 Straight



EI-328-15
Selman Dissecting Forcep
 Overall Length 15.5 cm (6")

Micro Vessel Dilator
 Overall Length 18 cm (7")

Tissue Forceps
Chirurgische Pinzetten
Pinzas de disección con diente
Pinces à dissection à griffes
Pinze per dissezione con denti

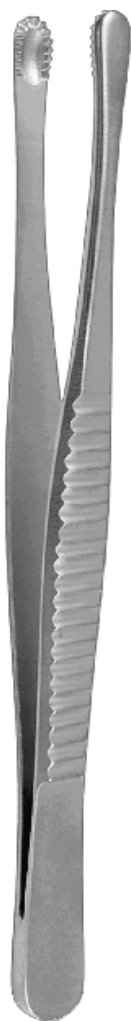

Russian Modell Dissecting Forcep



EI-330-15
15 cm (5")

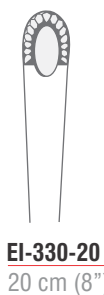

EI-330-20
20 cm (8")

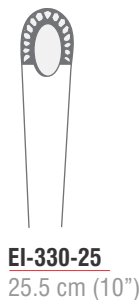

EI-330-25
25.5 cm (10")



Durante Dissecting Forcep



EI-332-14
14.5 cm (5 3/4")



EI-332-16
16 cm (6 1/4")



EI-332-20
20.5 cm (8")

Dissektionzangen
 &hätorgische Pinzetten
 Pinzas de disección con diente
 Pincés à dissection à griffes
 Pinze per dissezione con denti

EVA

FORCEPS



Stille-Barraya Dissecting Forcep

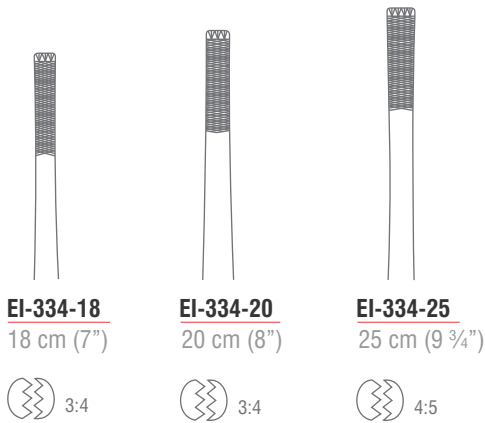

EI-334-18
18 cm (7")



EI-334-20
20 cm (8")



EI-334-25
25 cm (9 3/4")



EI-336-18
Ferris-Smith Dissecting Forcep
 2 x 3 Teeth
 Overall Length 18 cm (7")



Tissue Forceps
Chirurgische Pinzetten
Pinzas de disección con diente
Pincès à dissection à griffes
Pinze per dissezione con denti



EI-338-18
Bonney Dissecting Forcep
1 x 2 Teeth
Overall Length 17.5 cm (7")



EI-340-18
Mayo (Russian) Dissecting Forcep
Overall Length 23 cm (9")



Singley-Tuttle Dissecting Forcep

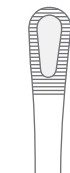

EI-344-18
18 cm (7")



EI-344-23
23 cm (9")

Tissue Forceps
Chirurgische Pinzetten
Pinzas de disección con diente
Pincès à dissection à griffes
Pinze per dissezione con denti

EVA

FORCEPS



Collin-Duval Tissue Grasping Forcep
Overall Length 20 cm (8")



EI-348-14
14.0 mm



EI-348-18
18.0 mm

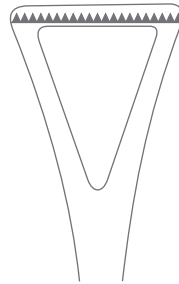

EI-348-23
23.0 mm

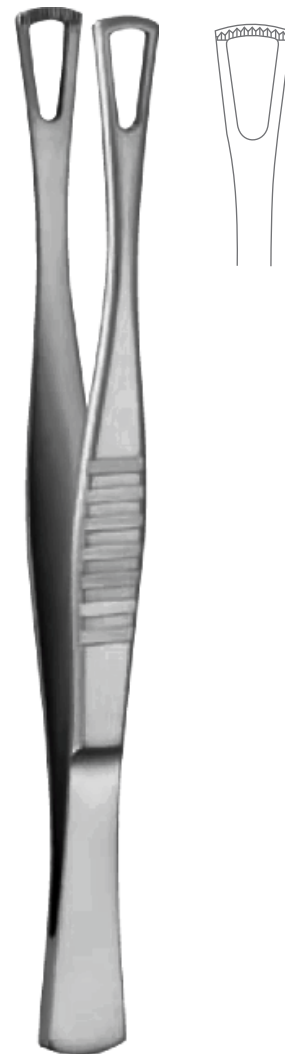

EI-350-14
Duval Tissue Forcep
Overall Length 14 cm (5 1/2")

Tissue Forceps
Chirurgische Pinzetten
Pinzas de disección con diente
Pinces à dissection à griffes
Pinze per dissezione con denti



EI-352-19
Dennis-Browne Intestinal Forcep
Overall Length 19 cm (7 1/2")



Nelson Dissecting Forcep
7 x 8 Teeth



EI-354-15
16 cm (6")

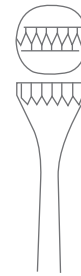

EI-354-23
23 cm (9")



7:8



Lane Dissecting Forcep

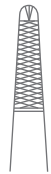

EI-360-12
1 x 2 Teeth
12.5 cm (5")

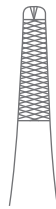

EI-360-14
1 x 2 Teeth
14.5 cm (5 3/4")

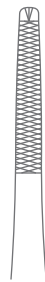

EI-360-17
1 x 2 Teeth
17.5 cm (7")



EI-362-14
2 x 3 Teeth
14.5 cm (5 3/4")



EI-362-17
2 x 3 Teeth
17.5 cm (7")



1:2



2:3

Tissue Forceps
Chirurgische Pinzetten
Pinzas de disección con diente
Pincers à dissection à griffes
Pinze per dissezione con denti

EVA

FORCEPS

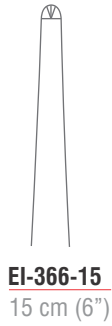
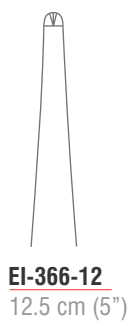

Treves Dissecting Forcep
1 x 2 Teeth



Ramsey Dissecting Forcep
Overall Length 18 cm (7")

Tissue Forceps
Chirurgische Pinzetten
Pinzas de disección con diente
Pinces à dissection à griffes
Pinze per dissezione con denti



Strassburger Modell Dissecting Forcep
1 x 2 Teeth

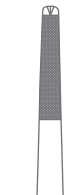

EI-374-15
15 cm (6")



EI-374-20
20 cm (8")



EI-376-14
Jackson-Burrows Dissecting Forcep
1 x 2 Teeth, With Platform
Overall Length 14 cm (5 1/2")



EI-378-18
Charnley Dissecting Forcep
1 x 2 Teeth, With Platform
Overall Length 18 cm (7")



Micro Forceps
 Mikropinzetten
 Micro Pinzas
 Micro-Pinces
 Micro-Pinze

EVA

FORCEPS



EI-401-02
 Right
 Ø 3.0 mm

EI-401-02
 Left
 Ø 3.0 mm

Samii Tumor Grasping Forcep
 Bayonet Shaped
 Overall Length 24 cm (9 1/2")



EI-403-01
 Ø 3.0 mm

EI-403-02
 Ø 5.0 mm

Yasargil Tumor Grasping Forcep
 Bayonet Shaped
 Overall Length 22 cm (8 3/4")



EI-403-03
 Ø 3.0 mm

EI-403-04
 Ø 5.0 mm

Yasargil Tumor Grasping Forcep
 Bayonet Shaped
 Overall Length 22 cm (8 3/4")

Micro Forceps
Mikropinzetten
Micro Pinzas
Micro-Pinces
Micro-Pinze



EI-405-01
Ø 3.0 mm

Heifetz Tumor Grasping Forcep
Bayonet Shaped
Overall Length 22 cm (8 3/4")



EI-405-02
Ø 5.0 mm



EI-407-20
Hunt Tumor Grasping Forcep
Angled
Overall Length 20 cm (8")



EI-409-01
Adson Hypophyseal Forcep
6.0 mm, Bayonet Shaped
Overall Length 23 cm (9")

Micro Forceps
Mikropinzetten
Micro Pinzas
Micro-Pinces
Micro-Pinze

EVA

FORCEPS



EI-411-16
0.6 mm
16 cm (6 1/4")

EI-411-18
0.6 mm
18 cm (7")

EI-411-20
0.6 mm
20 cm (8")

EI-411-22
0.6 mm
22 cm (8 3/4")

EI-411-22
0.6 mm
24 cm (9 1/2")

EI-413-16
0.9 mm
16 cm (6 1/4")

EI-413-18
0.9 mm
18 cm (7")

EI-413-20
0.9 mm
20 cm (8")

EI-413-22
0.9 mm
22 cm (8 3/4")

EI-413-22
0.9 mm
24 cm (9 1/2")



EI-024-13
Diam-n-Dust™ Yasargil Micro Forcep
Bayonet Shaped

Micro Forceps
Mikropinzetten
Micro Pinzas
Micro-Pinces
Micro-Pinze



Yasargil Micro Forcep
1 x 2 Teeth, Bayonet Shaped

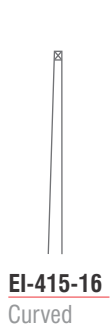

EI-415-16
Curved

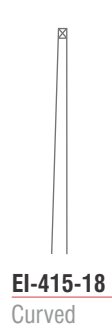

EI-415-18
Curved

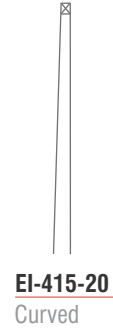

EI-415-20
Curved



Lazar Micro Suturing Forcep
Overall Length 15.5 cm (6")

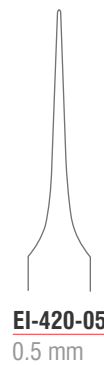

EI-420-05
0.5 mm



EI-420-08
0.8 mm

Grasping Forceps
Fasspinzetten
Pinzas para coger
Pincers pour saisir les tissus
Pinze per afferrare tessuti

EVA

FORCEPS

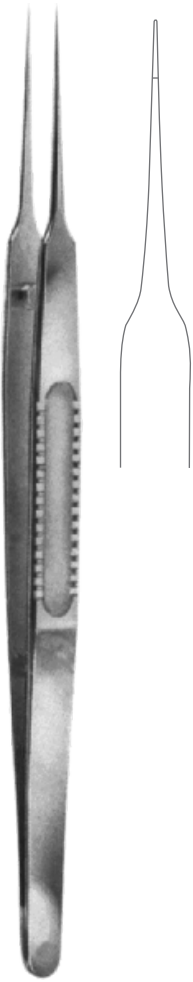

EI-422-18
Micro Suturing Forcep
0.5 mm, With Platform
Overall Length 18.5 cm (7 ¼")



EI-424-14
Austin Micro Suturing Forcep
0.8 mm, With Platform
Overall Length 14 cm (5 ½")

Micro Forceps
Mikropinzetten
Micro Pinzas
Micro-Pinces
Micro-Pinze



Micro Suturing Forcep
With Platform



EI-430-12
0.3 mm
Straight
12 cm (4 3/4")

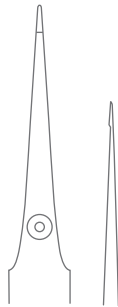

EI-430-15
0.3 mm
Straight
15 cm (6")



EI-431-12
0.3 mm
Curved
12 cm (4 3/4")

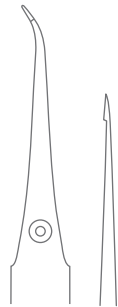

EI-431-12
0.3 mm
Curved
15 cm (6")

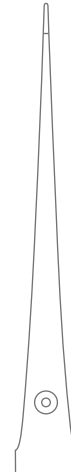

EI-432-18
0.5 mm
Straight
18 cm (7")

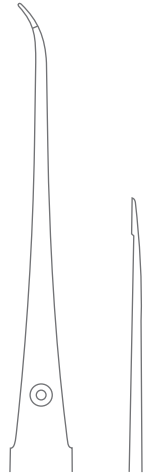

EI-433-18
0.5 mm
Curved
18 cm (7")

Micro Forceps
Mikropinzetten
Micro Pinzas
Micro-Pinces
Micro-Pinze

EVA

FORCEPS



EI-500-15

Straight
6.0 x 0.4 mm
15 cm (6")



EI-500-18

Straight
6.0 x 0.4 mm
18 cm (7")



EI-501-15

Curved
6.0 x 0.4 mm
15 cm (6")



EI-501-18

Curved
6.0 x 0.4 mm
18 cm (7")



Diam-n-Dust™ Micro Dressing Forcep



EI-500-15 T

Straight
6.0 x 0.4 mm
15 cm (6")



EI-500-18 T

Straight
6.0 x 0.4 mm
18 cm (7")



EI-501-15 T

Curved
6.0 x 0.4 mm
15 cm (6")



EI-501-18 T

Curved
6.0 x 0.4 mm
18 cm (7")



Diam-n-Dust™ Micro Dressing Forcep
Titanium

Micro Forceps
Mikropinzetten
Micro Pinzas
Micro-Pinces
Micro-Pinze



Diam-n-Dust™ Micro Dressing Forcep



EI-504-15
Straight
6.0 x 0.7 mm
15 cm (6")



EI-504-18
Straight
6.0 x 0.7 mm
18 cm (7")



EI-504-21
Straight
6.0 x 0.7 mm
21 cm (8 1/4")



EI-504-23
Straight
6.0 x 0.7 mm
23 cm (9")



EI-505-15
Curved
6.0 x 0.7 mm
15 cm (6")



EI-505-18
Curved
6.0 x 0.7 mm
18 cm (7")



EI-505-21
Curved
6.0 x 0.7 mm
21 cm (8 1/4")



EI-505-23
Curved
6.0 x 0.7 mm
23 cm (9")



Diam-n-Dust™ Micro Dressing Forcep
Titanium



EI-504-15 T
Straight
6.0 x 0.7 mm
15 cm (6")



EI-504-18 T
Straight
6.0 x 0.7 mm
18 cm (7")



EI-504-21 T
Straight
6.0 x 0.7 mm
21 cm (8 1/4")



EI-505-15 T
Curved
6.0 x 0.7 mm
15 cm (6")



EI-505-18 T
Curved
6.0 x 0.7 mm
18 cm (7")



EI-505-21 T
Curved
6.0 x 0.7 mm
21 cm (8 1/4")



Micro Forceps
Mikropinzetten
Micro Pinzas
Micro-Pinces
Micro-Pinze

EVA

FORCEPS



EI-508-15
Straight
1 x 2 Teeth
6.0 x 4.0 mm
15 cm (6")



EI-508-18
Straight
1 x 2 Teeth
6.0 x 4.0 mm
18 cm (7")



EI-509-15
Curved
1 x 2 Teeth
6.0 x 4.0 mm
15 cm (6")



EI-509-18
Curved
1 x 2 Teeth
6.0 x 4.0 mm
18 cm (7")



Diam-n-Dust™ Micro Dressing Forcep



EI-508-15 T
Straight
1 x 2 Teeth
6.0 x 4.0 mm
15 cm (6")



EI-508-18 T
Straight
1 x 2 Teeth
6.0 x 4.0 mm
18 cm (7")



EI-509-15 T
Curved
1 x 2 Teeth
6.0 x 4.0 mm
15 cm (6")



EI-509-18 T
Curved
1 x 2 Teeth
6.0 x 4.0 mm
18 cm (7")



Diam-n-Dust™ Micro Dressing Forcep
Titanium

Micro Forceps
Mikropinzetten
Micro Pinzas
Micro-Pinces
Micro-Pinze



Diam-n-Dust™ Micro Dressing Forcep



EI-512-15
Straight
1 x 2 Teeth
6.0 x 0.7 mm
15 cm (6")



EI-512-18
Straight
1 x 2 Teeth
6.0 x 0.7 mm
18 cm (7")



EI-512-21
Straight
1 x 2 Teeth
6.0 x 0.7 mm
21 cm (8 ¼")



EI-512-23
Straight
1 x 2 Teeth
6.0 x 0.7 mm
23 cm (9")

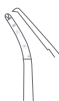

EI-513-15
Curved
1 x 2 Teeth
6.0 x 0.7 mm
15 cm (6")

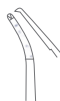

EI-513-18
Curved
1 x 2 Teeth
6.0 x 0.7 mm
18 cm (7")



EI-513-21
Curved
1 x 2 Teeth
6.0 x 0.7 mm
21 cm (8 ¼")



EI-513-23
Curved
1 x 2 Teeth
6.0 x 0.7 mm
23 cm (9")



Diam-n-Dust™ Micro Dressing Forcep
Titanium



EI-512-15 T
Straight
1 x 2 Teeth
6.0 x 0.7 mm
15 cm (6")



EI-512-18 T
Straight
1 x 2 Teeth
6.0 x 0.7 mm
18 cm (7")



EI-512-21 T
Straight
1 x 2 Teeth
6.0 x 0.7 mm
21 cm (8 ¼")



EI-513-15 T
Straight
1 x 2 Teeth
6.0 x 0.7 mm
15 cm (6")



EI-513-18 T
Straight
1 x 2 Teeth
6.0 x 0.7 mm
18 cm (7")



EI-513-21 T
Curved
1 x 2 Teeth
6.0 x 0.7 mm
21 cm (8 ¼")



Micro Forceps
Mikropinzetten
Micro Pinzas
Micro-Pinces
Micro-Pinze

EVA

FORCEPS



EI-516-15

Ø 1.0 x 0.5 mm
15 cm (6")



EI-516-18

Ø 1.0 x 0.5 mm
18 cm (7")



EI-516-21

Ø 1.0 x 0.5 mm
21 cm (8 ¼")



EI-516-23

Ø 1.0 x 0.5 mm
23 cm (9")



EI-518-15

Ø 2.0 x 1.0 mm
15 cm (6")



EI-518-18

Ø 2.0 x 1.0 mm
18 cm (7")



EI-518-21

Ø 2.0 x 1.0 mm
21 cm (8 ¼")



EI-518-23

Ø 2.0 x 1.0 mm
23 cm (9")



Diam-n-Dust™ Micro Ring Forcep



EI-516-15 T

Ø 1.0 x 0.5 mm
15 cm (6")



EI-516-18 T

Ø 1.0 x 0.5 mm
18 cm (7")



EI-516-21 T

Ø 1.0 x 0.5 mm
21 cm (8 ¼")



EI-518-15 T

Ø 2.0 x 1.0 mm
15 cm (6")



EI-518-18 T

Ø 2.0 x 1.0 mm
18 cm (7")



EI-518-21 T

Ø 2.0 x 1.0 mm
21 cm (8 ¼")



Diam-n-Dust™ Micro Ring Forcep
Titanium

Micro Forceps
Mikropinzetten
Micro Pinzas
Micro-Pinces
Micro-Pinze



Micro Atrauma Forcep

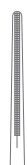

EI-520-15
1.2 mm
15 cm (6")



EI-520-18
1.2 mm
18 cm (7")

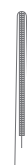

EI-520-21
1.2 mm
21 cm (8 1/4")



Micro Atrauma Forcep
Titanium

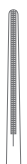

EI-520-15 T
1.2 mm
15 cm (6")



EI-520-18 T
1.2 mm
18 cm (7")



EI-520-21 T
1.2 mm
21 cm (8 1/4")



Micro Forceps
Mikropinzetten
Micro Pinzas
Micro-Pinces
Micro-Pinze

EVA

FORCEPS



EI-522-00
Straight
Ø 0.4 mm



EI-522-01
Curved
Ø 0.4 mm



EI-522-02
Angled
Ø 0.4 mm



FR-522-03
Ø 1.0 x 0.5 mm



Diam-n-Dust™ Micro Suturing Forcep
Overall Length 15 cm (6")

Diam-n-Dust™ Micro Ring Forcep
Overall Length 15 cm (6")

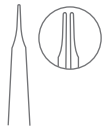
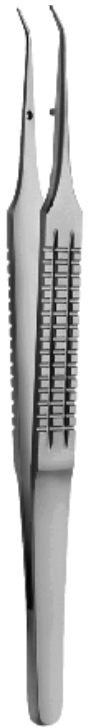

FR-524-04
Micro Vessel Dilator
Ø 0.3 mm
Overall Length 15 cm (6")

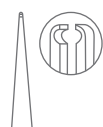

FR-524-05
Micro Pierce Dilator
Ø 0.4 mm
Overall Length 15 cm (6")

Micro Forceps
Mikropinzetten
Micro Pinzas
Micro-Pinces
Micro-Pinze



EI-526-00
Micro Vessel Dilator
Ø 0.3 mm
With Counter Balance
Overall Length 15 cm (6")



EI-526-01
Micro Pierce Dilator
Ø 0.3 mm
With Counter Balance
Overall Length 15 cm (6")



EI-528-00
Micro Vessel Dilator
Ø 0.3 mm
With Counter Balance
Overall Length 18 cm (7")



EI-528-01
Micro Pierce Dilator
Ø 0.3 mm
With Counter Balance
Overall Length 18 cm (7")

Micro Forceps
Mikropinzetten
Micro Pinzas
Micro-Pinces
Micro-Pinze

EVA

FORCEPS



EI-530-15
Ø 1.0 mm
15 cm (6")



EI-530-18
Ø 1.0 mm
18.5 cm (7 ¼")



EI-530-21
Ø 1.0 mm
21 cm (8 ¼")



EI-530-23
Ø 1.0 mm
23 cm (9")



EI-530-25
Ø 1.0 mm
25 cm (9 ¾")



EI-531-15
Ø 1.0 mm
15 cm (6")



EI-531-18
Ø 1.0 mm
18.5 cm (7 ¼")



EI-531-21
Ø 1.0 mm
21 cm (8 ¼")



EI-531-23
Ø 1.0 mm
23 cm (9")



EI-531-25
Ø 1.0 mm
25 cm (9 ¾")



Diam-n-Dust™ Micro Ring Forcep
Straight, With Counter Balance

Micro Forceps
Mikropinzetten
Micro Pinzas
Micro-Pinces
Micro-Pinze

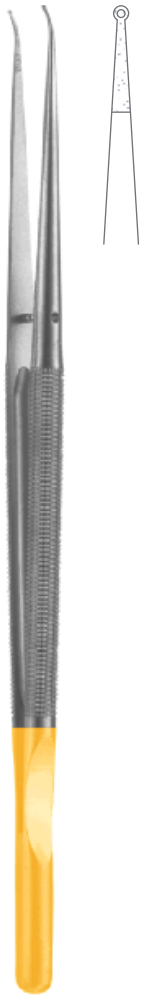

EI-534-18
Diam-n-Dust™ Micro Ring Forcep
Straight, Ø 2.0 mm
With Counter Balance
Overall Length 18.5 cm (7 ¼")



Diam-n-Dust™ Micro Suturing Forcep
With Counter Balance



EI-536-15
Straight
15 cm (6")



EI-536-18
Straight
18.5 cm (7 ¼")



EI-536-21
Straight
21 cm (8 ¼")



EI-536-25
Straight
25 cm (9 ¾")



EI-5EI-15
Curved
15 cm (6")



EI-5EI-18
Curved
18.5 cm (7 ¼")



EI-5EI-21
Curved
21 cm (8 ¼")



EI-5EI-25
Curved
25 cm (9 ¾")

Micro Forceps
Mikropinzetten
Micro Pinzas
Micro-Pinces
Micro-Pinze

EVA

FORCEPS



EI-540-18
1.2 mm
18.5 cm (7 ¼")



EI-540-21
1.2 mm
21 cm (8 ¼")



EI-540-18 T
1.2 mm
18.5 cm (7 ¼")



Micro Atrauma Forcep
With Counter Balance

Micro Atrauma Forcep
With Counter Balance
Titanium



Micro Forceps
Mikropinzetten
Micro Pinzas
Micro-Pinces
Micro-Pinze



Diam-n-Dust™ Micro Ring Forcep



EI-550-18
Ø 1.0 mm
Straight
With Long Platform
18.5 cm (7 1/4")



EI-550-21
Ø 1.0 mm
Straight
With Long Platform
21 cm (8 1/4")



EI-551-18
Ø 1.0 mm
Curved
With Long Platform
18.5 cm (7 1/4")



EI-551-21
Ø 1.0 mm
Curved
With Long Platform
21 cm (8 1/4")



EI-552-18
Ø 1.0 mm
Straight
With Short Platform
18.5 cm (7 1/4")



EI-552-21
Ø 1.0 mm
Straight
With Short Platform
21 cm (8 1/4")



EI-554-18
Ø 1.0 mm
Straight
18.5 cm (7 1/4")



EI-554-21
Ø 1.0 mm
Curved
21 cm (8 1/4")

Micro Forceps
Mikropinzetten
Micro Pinzas
Micro-Pinces
Micro-Pinze

EVA

FORCEPS

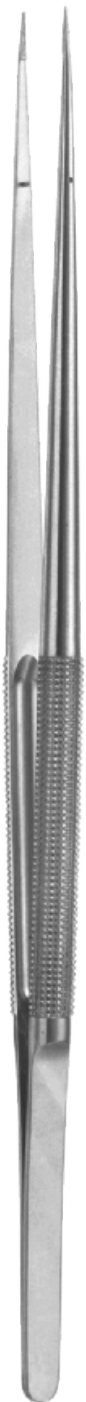

EI-556-18
1.2 mm
18.5 cm (7 1/4")



EI-556-18
1.2 mm
21 cm (8 1/4")

Micro Atrauma Forcep
Straight

Micro Forceps
Mikropinzetten
Micro Pinzas
Micro-Pinces
Micro-Pinze



Gerald Micro Forceps
Cross Serrated Jaws

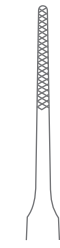

EI-558-18
1.0 mm
18 cm (7")



EI-558-25
1.0 mm
25 cm (9 3/4")



Gerald (DeBakey) Micro Atrauma Forceps
Cross Serrated Jaws



EI-560-18
1.0 mm
18 cm (7")



EI-560-21
1.0 mm
20 cm (8")

Micro Forceps
Mikropinzetten
Micro Pinzas
Micro-Pinces
Micro-Pinze

EVA

FORCEPS



EI-562-18
1.0 mm



EI-563-18
1.0 mm



EI-566-18
1.0 mm
18 cm (7")



EI-566-20
1.0 mm
20 cm (8")



EI-566-18 T
1.0 mm

Diam-n-Dust™ Gerald Micro Ring Forcep
Overall Length 18 cm (7")

Diam-n-Dust™ Gerald Micro Suturing Forcep

Diam-n-Dust™ Gerald Micro Suturing Forcep
Titanium
Overall Length 18 cm (7")



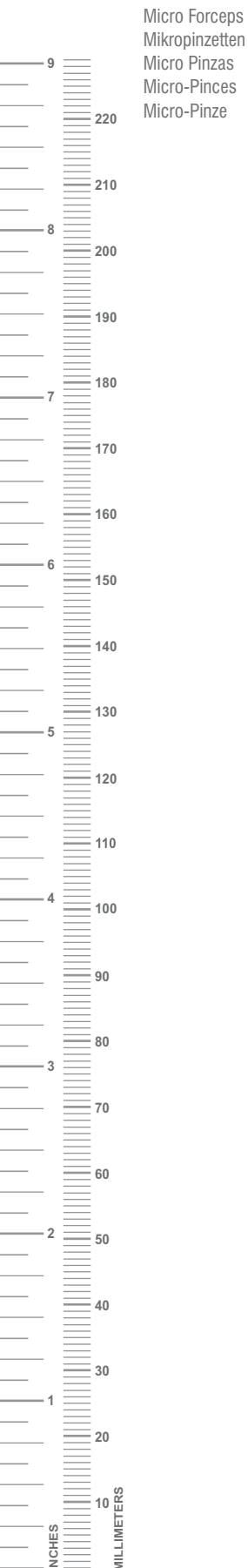

Micro Forceps
Mikropinzetten
Micro Pinzas
Micro-Pinces
Micro-Pinze



EI-568-20
Micro Dressing Forcep
Cross Serrated Jaws
Overall Length 20 cm (8")



Resano Forcep Multi-Toothed



EI-570-18
18 cm (7")



EI-570-23
23 cm (9")



EI-570-32
32 cm (12 ½")



Vascular Forceps
Gefäßpinzetten
Pinzas de disección vascular
Pincès à dissection vasculaires
Pinze per dissezione vascolari

EVA

FORCEPS



EI-580-15
1.2 mm
15 cm (6")

EI-582-20
1.5 mm
20 cm (8")

EI-582-24
1.5 mm
24 cm (9 1/2")

EI-582-30
1.5 mm
30 cm (11 3/4")

DeBakey Atrauma Forcep
Ultra Light Pattern

Vascular Forceps
Gefäßpinzetten
Pinzas de disección vascular
Pinces à dissection vasculaires
Pinze per dissezione vascolari



DeBakey Atrauma Forcep



EI-584-15
1.2 mm
15 cm (6")



EI-584-20
1.2 mm
20 cm (8")



EI-584-24
1.2 mm
24 cm (9 1/2")



DeBakey Atrauma Forcep



EI-590-16
1.5 mm
16 cm (6 1/4")



EI-590-20
1.5 mm
20 cm (8")



EI-590-24
1.5 mm
24.5 cm (9 3/4")



EI-590-30
1.5 mm
30 cm (11 3/4")

Vascular Forceps
Gefäßpinzetten
Pinzas de disección vascular
Pincès à dissection vasculaires
Pinze per dissezione vascolari

EVA

FORCEPS

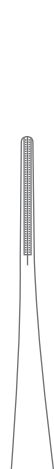

EI-590-16 T
1.5 mm
16 cm (6 1/4")



EI-590-20 T
1.5 mm
20 cm (8")



EI-590-24 T
1.5 mm
24.5 cm (9 3/4")



TITANIUM

DeBakey Atrauma Forcep
Titanium



EI-592-16
2.0 mm
16 cm (6 1/4")



EI-592-20
2.0 mm
20 cm (8")



EI-592-24
2.0 mm
24.5 cm (9 3/4")



EI-592-30
2.0 mm
30 cm (11 3/4")

DeBakey Atrauma Forcep

Vascular Forceps
Gefäßpinzetten
Pinzas de disección vascular
Pinces à dissection vasculaires
Pinze per dissezione vascolari



DeBakey Atrauma Forcep
Titanium

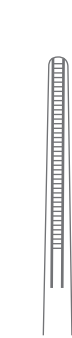

EI-592-16 T
2.0 mm
16 cm (6 1/4")

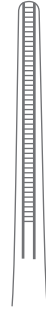

EI-592-20 T
2.0 mm
20 cm (8")



EI-592-24 T
2.0 mm
24.5 cm (9 3/4")



DeBakey Atrauma Forcep
Angled



EI-593-16
2.0 mm
16 cm (6 1/4")

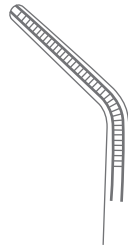

EI-593-20
2.0 mm
19.5 cm (7 3/4")

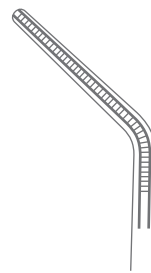

EI-593-24
2.0 mm
24.5 cm (9 3/4")

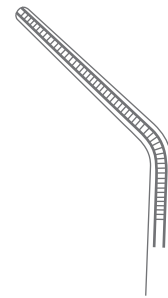

EI-593-30
2.0 mm
29.5 cm (11 1/2")

Vascular Forceps
Gefäßpinzetten
Pinzas de disección vascular
Pincers à dissection vasculaires
Pinze per dissezione vascolari

EVA

FORCEPS



DeBakey Atrauma Forcep



EI-594-16
2.8 mm
16 cm (6 1/4")

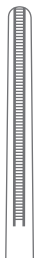

EI-594-20
2.8 mm
20 cm (8")



EI-594-24
2.8 mm
24.5 cm (9 3/4")



EI-594-30
2.8 mm
30 cm (11 3/4")



DeBakey Atrauma Forcep

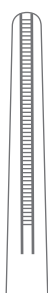

EI-596-16
3.5 mm
16 cm (6 1/4")



EI-596-20
3.5 mm
20 cm (8")

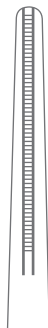

EI-596-24
3.5 mm
24.5 cm (9 3/4")



EI-596-30
3.5 mm
30 cm (11 3/4")

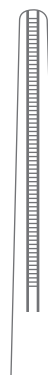

EI-596-35
3.5 mm
35 cm (13 3/4")

Vascular Forceps
Gefäßpinzetten
Pinzas de disección vascular
Pinces à dissection vasculaires
Pinze per dissezione vascolari



Cooley Atrauma Forcep

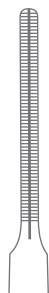

EI-598-16
2.0 mm
16 cm (6 ¼")

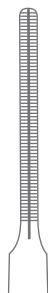

EI-598-20
2.0 mm
20 cm (8")



EI-598-24
2.0 mm
24 cm (9 ½")

Splinter Forceps
Splitterpinzetten
Pinzas para espinas
Pincas à échardes
Pinze per scheggie

EVA

FORCEPS



Splinter Forcep
Straight, Smooth Jaws



EI-600-10
10 cm (4")

EI-600-10
12.5 cm (5")



EI-601-12
Curved
Smooth Jaws
12.5 cm (5")



EI-603-10
Systrunk Nail Splitting Scissor
Angled, Smooth Jaws
Overall Length 10 cm (4")



Splinter Forcep
Serrated Jaws

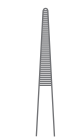

EI-606-09
Straight
9 cm (3 1/2")



EI-606-10
Straight
10.5 cm (4")



EI-606-11
Straight
11.5 cm (4 1/2")



EI-606-13
Straight
13 cm (5")



EI-606-14
Straight
14.5 cm (5 3/4")



EI-607-09
Curved
9 cm (3 1/2")



EI-607-10
Curved
10.5 cm (4")



EI-607-11
Curved
11.5 cm (4 1/2")



EI-607-13
Curved
13 cm (5")

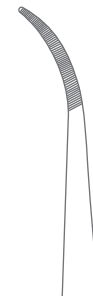

EI-607-14
Curved
14.5 cm (5 3/4")

Splinter Forceps
Splitterpinzetten
Pinzas para espinas
Pinces à échardes
Pinze per scheggie



Feilchenfeld Splinter Forcep



EI-610-07
7.5 cm (3 1/4")

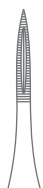

EI-610-09
9 cm (3 1/2")

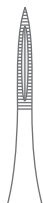

EI-610-11
11.5 cm (4 1/2")



Hunter Splinter Forcep
Overall Length 10.5 cm (4")



EI-612-10
Straight

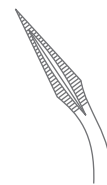

EI-613-10
Curved



EI-614-07
Splinter Forcep
With Magnifying Glass
Overall Length 7.5 cm (3")



EI-620-09
Shaaf Splinter Forcep
Overall Length 9.5 cm (3 3/4")

Cilia Forceps
Zilienzange
Pinzas para cilios
Pincès à cils
Pinze Cilia

EVA

FORCEPS



EI-622-08
Littauer Cilia Forcep
Smooth Jaws
Overall Length 8.5 cm (3 1/4")



EI-624-09
Bergh Cilia Forcep
Serrated Jaws
Overall Length 8.5 cm (3 1/4")



EI-626-09
Douglas Cilia Forcep
Narrow Tip
Overall Length 9 cm (3 1/2")



EI-628-09
Douglas Cilia Forcep
Wide Tip
Overall Length 9 cm (3 1/2")



EI-630-09
Beer Cilia Forcep
Smooth Jaws
Overall Length 9 cm (3 1/2")



Barraquer Cilia Forcep
Overall Length 10.5 cm (4")

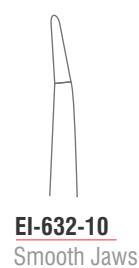

EI-632-10
Smooth Jaws



EI-632-10
Cross Serrated Jaws

Splinter Forceps
Splitterpinzetten
Pinzas para espinas
Pinces à échardes
Pinze per scheggie



EI-635-07
Single Use Barsewisch Anterior Chamber Forcep
Angled, With Tying Platform
Overall Length 7.5 cm (3")



EI-650-14
Straight
14 cm (5 1/2")

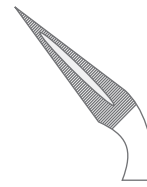

EI-651-14
Curved
13.5 cm (5 1/4")

Stieglitz Splinter Forcep



EI-655-11
Peet Splinter Forcep
Overall Length 12.5 cm (5")



EI-660-15
Straight

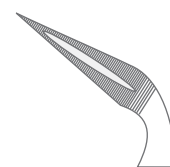

EI-661-15
Curved

Ralk Splinter Forcep
Overall Length 15 cm (6")

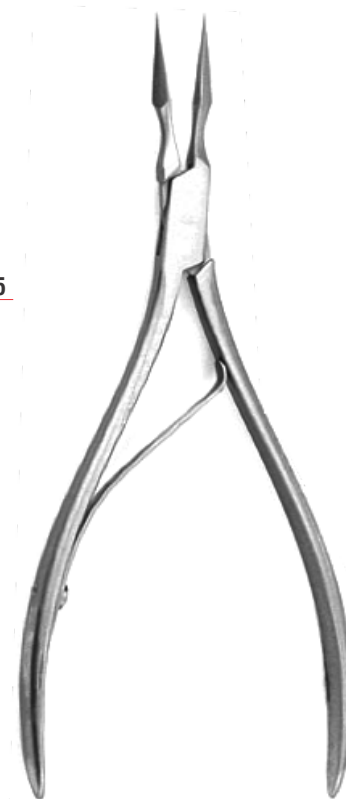

EI-664-15
Vitus Splinter Forcep
Straight
Overall Length 15 cm (6")

Micro Forceps
Mikropinzetten
Micro Pinzas
Micro-Pinces
Micro-Pinze

EVA

FORCEPS



Vitrectomy Forcep
14 cm (5 1/2")



EI-680-20
Straight, Serrated Tip 20 G

EI-680-23
Straight, Serrated Tip 23 G



EI-682-20
Straight, End Grasping Jaws
Horizontal Opening Tip 20 G

EI-682-23
Straight, End Grasping Jaws
Horizontal Opening Tip 23 G



EI-685-20
Smooth Side, Gripping Jaws
Vertical Opening Tip 20 G



EI-687-20
Membrane Peeling, Smooth
45°Angled Jaws, 20 G



EI-689-23
Asymmetrical Jaws 23 G



EI-690-23
ILM 23 G

Micro Forceps
Mikropinzetten
Micro Pinzas
Micro-Pinces
Micro-Pinze



EI-692-20
ICL Lens Cartridge Loading Forcep
Straight, 20 G
Jaws Feature a Series of Concave and Convex Surfaces

ICL® is a registered trademark of STAAR Surgical Company



EI-695-23
Alio MICS Capsulorrhexis Forcep
23 G, Curved Shaft With Short Micro-Grasping Tip Designed For Use Through a Very Small Paracentesis.

Eye Surgery Forceps
 Augen Chirurgie Pinzetten
 Ojo Pinzas Cirugia
 Pince de chirurgie oculaire
 Eye Pinze Chirurgia

EVA

FORCEPS



EI-700-01
 Straight
 10 cm (4")



EI-700-02
 Gently Curved
 10 cm (4")



EI-700-03
 Strongly Curved
 9.5 cm (3 3/4")



EI-702-01
 Straight
 10 cm (4")



EI-702-02
 Gently Curved
 10 cm (4")



EI-702-03
 Strongly Curved
 9.5 cm (3 3/4")



Graefe Eye Dressing Forcep
 0.8 mm, Serrated Tips

Graefe Dissecting Forcep
 0.8 mm, 1 x 2 Teeth

Eye Surgery Forceps
Augenchirurgie Pinzetten
Ojo Pinzas Cirugía
Pince de chirurgie oculaire
Eye Pinze Chirurgia



EI-710-07
Botvin Iris Forcep
0.5 mm, Serrated
Overall Length 7.5 cm (3 1/4")



EI-712-07
Botvin Iris Forcep
0.3 mm, 1 x 2 Teeth
Overall Length 7.5 cm (3 1/4")



EI-714-07
Gills-Colibri Corneal Forcep
Very Fine Pointed Tip, With Tying Platform
Overall Length 7.5 cm (3 1/4")



EI-716-07
Colibri Corneal Forcep
Very Delicate, 1 x 2 Teeth, 0.12 mm
Overall Length 7.5 cm (3 1/4")



EI-718-07
Harms-Colibri Corneal Forcep
Very Delicate, 1 x 2 Oblique Teeth
0.12 mm With Tying Platform
Overall Length 7.5 cm (3 1/4")



EI-718-07 T
Harms-Colibri Corneal Forcep
Very Delicate, 1 x 2 Oblique Teeth
0.12 mm With Tying Platform
Overall Length 7.5 cm (3 1/4")



Eye Surgery Forceps
 Augenchirurgie Pinzetten
 Ojo Pinzas Cirugia
 Pince de chirurgie oculaire
 Eye Pinze Chirurgia

EVA

FORCEPS



EI-720-07
Colibri Corneal Forcep
 Standard 1 x 2 Teeth
 With Tying Platform, 0.4 mm
 Overall Length 7.5 cm (3 1/4")



EI-721-07
Pierce-Colibri Corneal Forcep
 1 x 1 Teeth, 0.12 mm
 Overall Length 7.5 cm (3 1/4")



EI-722-08
Hoskin Tissue Forcep
 Straight, 1 x 1 Teeth, 0.3 mm
 Overall Length 8 cm (3 1/4")



EI-723-08
Hoskin Tissue Forcep
 Curved, 1 x 1 Teeth, 0.3 mm
 Overall Length 8 cm (3 1/4")



Eye Surgery Forceps
Augenchirurgie Pinzetten
Ojo Pinzas Cirugía
Pince de chirurgie oculaire
Eye Pinze Chirurgia



EI-724-10
Fechtner Conjunctival Forcep
Very Delicate Ø 0.8 mm
Ring Shaped Tips
With 6 mm Long Tying Platform
Overall Length 10.5 cm (4")



EI-726-11
Castroviejo-Colibri Corneal Forcep
Very Delicate 1 x 2 Teeth, 0.12 mm
Overall Length 11 cm (4 ¼")



EI-728-11
Harms-Colibri Corneal Forcep
Very Delicate 1 x 2 Teeth, 0.12 mm
With Tying Platform
Overall Length 11 cm (4 ¼")



Eye Surgery Forceps
Augenchirurgie Pinzetten
Ojo Pinzas Cirugia
Pince de chirurgie oculaire
Eye Pinze Chirurgia

EVA

FORCEPS



EI-730-08
Bonn Corneal Forcep
Very Delicate 1 x 2 Teeth 0.12 mm
Overall Length 8.5 cm (4")



EI-732-10
Bonn Corneal Forcep
Very Delicate 1 x 2 Teeth
With Tying Platform, 0.12 mm
Overall Length 10 cm (4")



EI-732-10 T
Bonn Corneal Forcep
Very Delicate 1 x 2 Teeth
With Tying Platform, 0.12 mm, Titanium
Overall Length 10 cm (4")



EI-734-08
Bonn Corneal Forcep
Very Delicate, Serrated
Overall Length 8.5 cm (3 1/4")

Eye Surgery Forceps
Augenchirurgie Pinzetten
Ojo Pinzas Cirugía
Pince de chirurgie oculaire
Eye Pinze Chirurgia



EI-736-10
McPherson Suture Tying Forcep
Straight, 1 x 2 Teeth
With Tying Platform, 0.4 mm
Overall Length 10.5 cm (4")



EI-7EI-10
McPherson Suture Tying Forcep
Angled, 1 x 2 Teeth
With Tying Platform, 0.4 mm
Overall Length 10 cm (4")



EI-740-10
Kelman-McPherson Tissue Forcep
Angled, 1 x 2 Teeth
With Tying Platform, 0.3 mm
Overall Length 10 cm (4")



Eye Surgery Forceps
Augenchirurgie Pinzetten
Ojo Pinzas Cirugia
Pince de chirurgie oculaire
Eye Pinze Chirurgia

EVA

FORCEPS

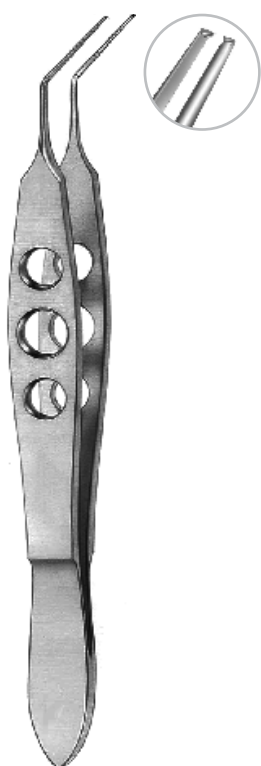

EI-742-10
Hoffer-McPherson Tissue Forcep
Very Delicate, 1 x 2 Teeth
11 mm, 0.12 mm
Overall Length 10 cm (4")



Castroviejo Suture Tying Forcep
1 x 2 Oblique Teeth With Tying Platform
Overall Length 11 cm (4 1/4")

- EI-750-01** 0.12 mm
- EI-750-03** 0.3 mm
- EI-750-05** 0.5 mm
- EI-750-09** 0.9 mm

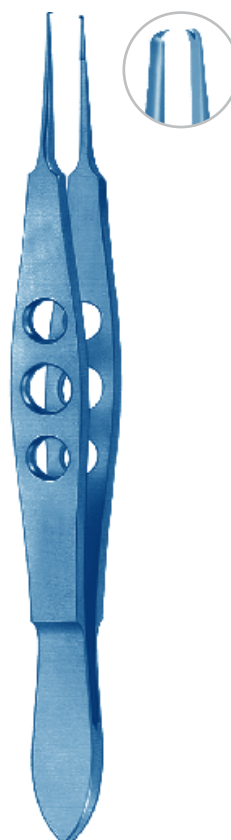

EI-750-01 T
Castroviejo Suture Tying Forcep
1 x 2 Oblique Teeth, With Tying Platform
0.12 mm, Titanium
Overall Length 11 cm (4 1/4")



Eye Surgery Forceps
Augenchirurgie Pinzetten
Ojo Pinzas Cirugía
Pince de chirurgie oculaire
Eye Pinze Chirurgia



Castroviejo Suture Tying Forcep
Angled, 1 x 2 Oblique Teeth
With Tying Platform
Overall Length 11 cm (4 1/4")

- EI-751-01** 0.12 mm
- EI-751-03** 0.3 mm
- EI-751-05** 0.5 mm
- EI-751-09** 0.9 mm

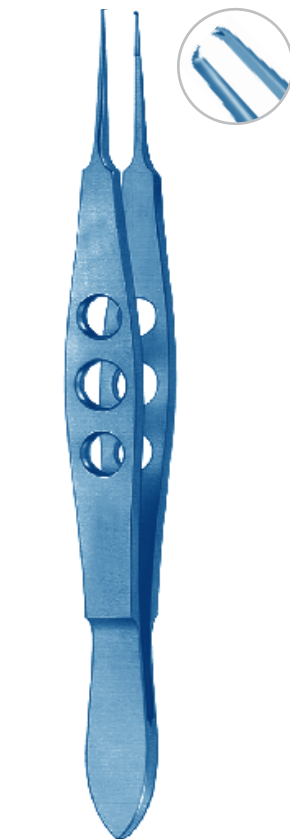

EI-751-01 T
Castroviejo Suture Tying Forcep
Angled, 1 x 2 Oblique Teeth With Tying Platform
0.12 mm, Titanium
Overall Length 11 cm (4 1/4")



TITANIUM



EI-752-05
Stern-Castroviejo Suture Tying Forcep
1 x 2 Teeth, 0.5 mm
Overall Length 11 cm (4 1/4")



Eye Surgery Forceps
Augenchirurgie Pinzetten
Ojo Pinzas Cirugia
Pince de chirurgie oculaire
Eye Pinze Chirurgia



EI-754-10
Girard Corneoscleral Forcep
1 x 2 Teeth With Tying Platform
For Right Hand, 0.12 mm
Overall Length 10.5 cm (4")



EI-756-10
Girard Corneoscleral Forcep
1 x 2 Teeth With Tying Platform
For Left Hand, 0.12 mm
Overall Length 10.5 cm (4")



Bishop-Harmon Iris Forcep
Overall Length 8.5 cm (3 1/4")



EI-758-08
0.3 mm Delicate
1 x 2 Teeth



EI-760-08
0.8 mm Standard
1 x 2 Teeth

Eye Surgery Forceps
Augenchirurgie Pinzetten
Ojo Pinzas Cirugía
Pince de chirurgie oculaire
Eye Pinze Chirurgia



EI-762-09
Bishop-Harmon Dressing Forcep
0.8 mm, Cross Serrated Jaws
Overall Length 8.5 cm (3 1/4")



EI-764-09
St. Martin's Suture Tying Forcep
0.3 mm, 1 x 2 Oblique Teeth
With 5.0 mm Tying Platform
Overall Length 9 cm (3 1/2")



EI-765-09
Paufique Suture Tying Forcep
0.5 mm, 1 x 2 Oblique Teeth
With 5.0 mm Tying Platform
Overall Length 9 cm (3 1/2")



EI-766-09
Sauer Fixation Forcep
0.3 mm, 1 x 2 Oblique Teeth
Overall Length 9 cm (3 1/2")



Eye Surgery Forceps
Augenchirurgie Pinzetten
Ojo Pinzas Cirugia
Pince de chirurgie oculaire
Eye Pinze Chirurgia

EVA

FORCEPS

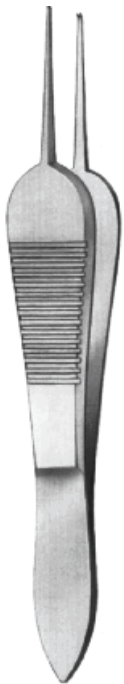

EI-768-09
Manhattan Eye & Ear Fixation Forcep
1 x 2 Teeth, 0.3 mm, With Tying Platform
Overall Length 9 cm (3 1/2")



1:2



EI-770-11
Elschnig Fixation Forcep
0.9 mm, 1 x 2 Oblique Teeth
Overall Length 11 cm (4 1/4")



1:2



EI-772-01
Graefe Fixation Forcep
4.5 mm Wide Jaws
Without Lock
Overall Length 11 cm (4 1/4")



EI-772-02
Graefe Fixation Forcep
4.5 mm Wide Jaws
With Lock
Overall Length 11 cm (4 1/4")

Eye Surgery Forceps
Augenchirurgie Pinzetten
Ojo Pinzas Cirugía
Pince de chirurgie oculaire
Eye Pinze Chirurgia



EI-774-10
Green Fixation Forcep
9.0 mm Wide Jaws
Overall Length 10.5 cm (4")



EI-774-11
Troutman Superior Rectus Forcep
Angled, 0.5 mm 1 x 2 Oblique Teeth
Overall Length 11 cm (4 1/4")



Lester Fixation Forcep
Overall Length 9.5 cm (3 3/4")



EI-776-01
0.6 mm
1 x 2 Teeth



EI-776-02
0.6 mm
2 x 3 Teeth



Eye Surgery Forceps
Augenchirurgie Pinzetten
Ojo Pinzas Cirugia
Pince de chirurgie oculaire
Eye Pinze Chirurgia

EVA

FORCEPS

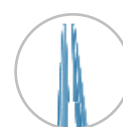

EI-7EI-01
Moody Fixation Forcep
Curved Right
Overall Length 11 cm (4 1/4")

EI-7EI-02
Moody Fixation Forcep
Curved Left
Overall Length 11 cm (4 1/4")

EI-780-10
McPherson Suture Tying Forcep
Straight, With Tying Platform
5.0 mm
Overall Length 10 cm (4")

EI-780-10 T
McPherson Suture Tying Forcep
Straight, With Tying Platform
5.0 mm Titanium
Overall Length 10 cm (4")



TITANIUM

Eye Surgery Forceps
Augenchirurgie Pinzetten
Ojo Pinzas Cirugía
Pince de chirurgie oculaire
Eye Pinze Chirurgia



EI-781-10
McPherson Suture Tying Forcep
Angled, With Tying Platform, 5 mm
Overall Length 10 cm (4")

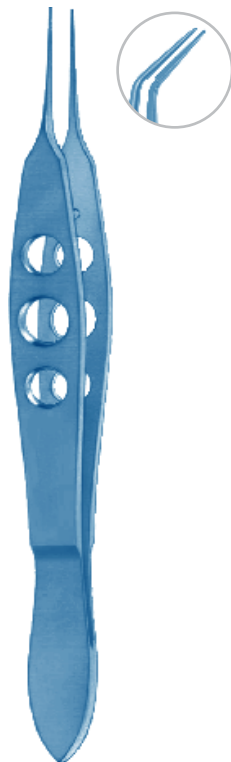

EI-781-10 T
McPherson Suture Tying Forcep
Angled, With Tying Platform, 5 mm Titanium
Overall Length 10 cm (4")



Eye Surgery Forceps
Augenchirurgie Pinzetten
Ojo Pinzas Cirugia
Pince de chirurgie oculaire
Eye Pinze Chirurgia



EI-784-10
Kelman-McPherson Suture Tying Forcep
Angled, With Tying Platform, 7.5 mm
Overall Length 10 cm (4")

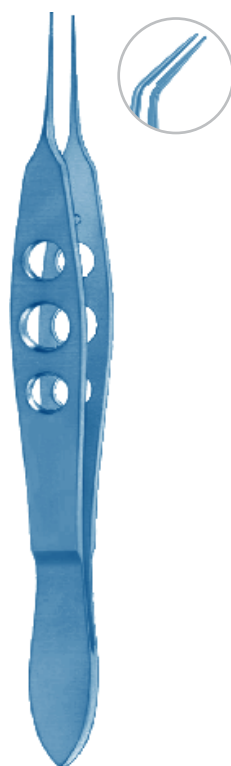

EI-784-10 T
Kelman-McPherson Suture Tying Forcep
Angled, With Tying Platform, 7.5 mm Titanium
Overall Length 10 cm (4")



EVA

FORCEPS



EI-790-10
Kurstin Flap Stretching Forcep
Disc Shaped, Serrated Jaws
Overall Length 10.5 cm (4")



EI-793-10
Buratto LASIK Flap Forcep
Curved, Disc Shaped, Serrated Jaws
Overall Length 10.5 cm (4")

Eye Surgery Forceps
Augenchirurgie Pinzetten
Ojo Pinzas Cirugía
Pince de chirurgie oculaire
Eye Pinze Chirurgia



EI-795-10
Mendez Multipurpose LASIK Forcep
Angled, Spatulated Jaws & Tip
Overall Length 10 cm (4")



EI-797-10
Kraff Capsule Tag Forcep
Angled, 11 mm, 1.5 mm
Overall Length 10.5 cm (4")



EI-801-10
Utrata Capsulorrhexis Forcep
Very Delicate Triangular Grasping Tips
Extremely Thin, 11 mm
Over Length 10.5 cm (4")

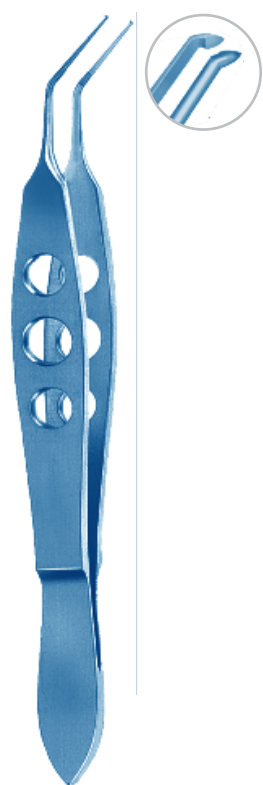

EI-801-10 T
Utrata Capsulorrhexis Forcep
Very Delicate Triangular Grasping Tips
Extremely Thin, 11 mm, Titanium
Overall Length 10.5 cm (4")



Eye Surgery Forceps
Augenchirurgie Pinzetten
Ojo Pinzas Cirugia
Pince de chirurgie oculaire
Eye Pinze Chirurgia

EVA

FORCEPS



EI-803-10
Jaffe Capsulorrhexis Forcep
Very Delicate Round Grasping Tip
Extremely Thin, 11 mm
Overall Length 10.5 cm (4")



EI-805-10
O'Gawa-Utrata Capsulorrhexis Forcep
Very Delicate, Round Grasping Tips
Extremely Thin
Overall Length 11.5 cm (4 1/2")

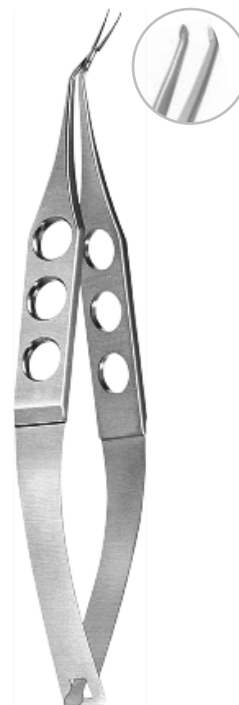

EI-807-11
Inamura Capsulorrhexis Forcep
Delicate Tapered 12 mm Long Shanks
Overall Length 11.5 cm (4 1/2")



EI-809-10
Masket Capsulorrhexis Forcep
With Very Delicate Triangle Grasping Tip & Very
Delicate Vaulted Shanks, Length 11 mm
Overall Length 11.5 cm (4 1/2")

Eye Surgery Forceps
Augenchirurgie Pinzetten
Ojo Pinzas Cirugía
Pince de chirurgie oculaire
Eye Pinze Chirurgia



EI-810-10
Jaffe Suture Tying Forcep
Straight, Very Delicate
Smooth Jaws, 6 mm
Overall Length 10.5 cm (4")



EI-811-10
Jaffe Suture Tying Forcep
Curved, Very Delicate
Smooth Jaws 6 mm
Overall Length 10.5 cm (4")



EI-816-10
Tennant Suture Tying Forcep
Straight, Round Handle With
Guide Pin Extra Delicate
Smooth Jaws, 6 mm
Overall Length 10.5 cm (4")

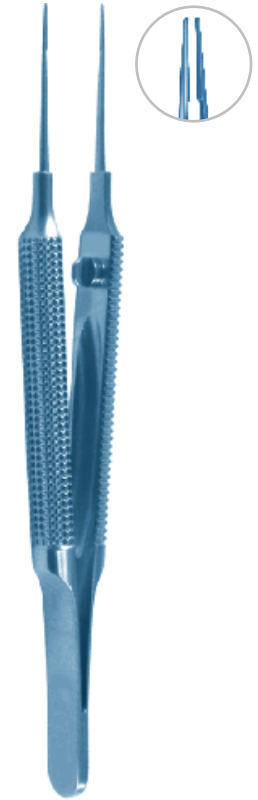

EI-816-10 T
Tennant Suture Tying Forcep
Straight, Round Handle With
Guide Pin Extra Delicate Smooth
Jaws, 6 mm
Overall Length 10.5 cm (4")



Eye Surgery Forceps
Augenchirurgie Pinzetten
Ojo Pinzas Cirugia
Pince de chirurgie oculaire
Eye Pinze Chirurgia

EVA

FORCEPS



EI-817-10
Tennant Suture Tying Forcep
Curved, Round Handle With
Guide Pin, Extra Delicate Smooth
Jaws, 6 mm
Overall Length 10.5 cm (4")



EI-817-10 T
Tennant Suture Tying Forcep
Curved, Round Handle With
Guide Pin, Extra Delicate Smooth
Jaws, 6 mm
Titanium
Overall Length 10.5 cm (4")



EI-820-10
Harms Suture Tying Forcep
Straight
Overall Length 10.5 cm (4")



EI-821-10
Harms Suture Tying Forcep
Curved
Overall Length 10.5 cm (4")



TITANIUM

Eye Surgery Forceps
Augenchirurgie Pinzetten
Ojo Pinzas Cirugía
Pince de chirurgie oculaire
Eye Pinze Chirurgia



EI-824-10
Helveston Suture Tying Forcep
Straight
Overall Length 10.5 cm (4")



EI-825-10
Fine Suture Tying Forcep
Curved
Overall Length 10.5 cm (4")

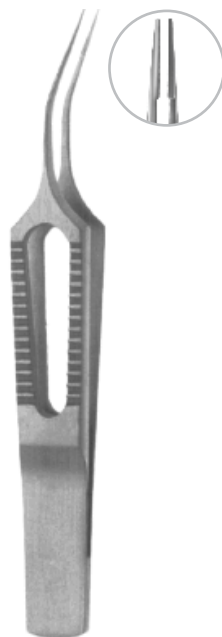

EI-827-08
Gerl Suture Tying Forcep
Smooth Jaws, Curved Shanks, 6 mm
Overall Length 8.5 cm (3 1/4")

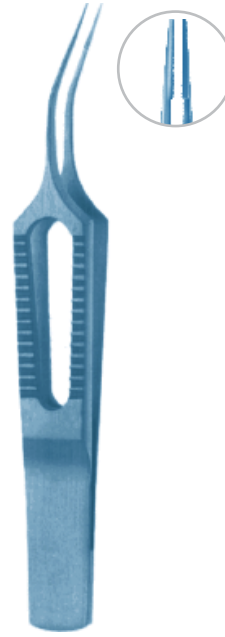

EI-827-08 T
Gerl Suture Tying Forcep
Smooth Jaws, Curved Shanks, 6 mm
Titanium
Overall Length 8.5 cm (3 1/4")



Eye Surgery Forceps
Augenchirurgie Pinzetten
Ojo Pinzas Cirugia
Pince de chirurgie oculaire
Eye Pinze Chirurgia

EVA

FORCEPS



EI-830-10
Gradle Cilia Forcep
Smooth Jaws
Overall Length 10 cm (4")



Bonacolto Conjunctival Forcep
Overall Length 10 cm (4")
EI-8EI-12
Longitudinal Serrated Jaws
With Cross Serrated Tips, 1.2 mm

EI-8EI-17
Longitudinal Serrated Jaws
With Cross Serrated Tips, 1.7 mm



EI-836-10
Lister Conjunctival Forcep
1 x 2 Teeth
Overall Length 10 cm (4")



1:2

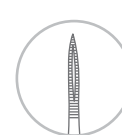

EI-838-10
Moorfield Conjunctival Forcep
Overall Length 10 cm (4")

Eye Surgery Forceps
Augenchirurgie Pinzetten
Ojo Pinzas Cirugía
Pince de chirurgie oculaire
Eye Pinze Chirurgia



Nugent Utility Forcep
Overall Length 10 cm (4")
EI-840-10
Smooth Jaws
EI-842-10
Serrated Jaws



EI-844-11
Lister Utility Forcep
Serrated Jaws, 1 x 2 Teeth
Overall Length 11 cm (4 1/4")
 1:2



EI-847-08
Scleral Plug Removing Forcep
Overall Length 8.5 cm - (3 1/2")



EI-846-10
Gold Punctal Plug Forcep
With Longitudinal Groove
Pointed Tip
Overall Length 11 cm (4 1/4")

Eye Surgery Forceps
Augenchirurgie Pinzetten
Ojo Pinzas Cirugia
Pince de chirurgie oculaire
Eye Pinze Chirurgia

EVA

FORCEPS

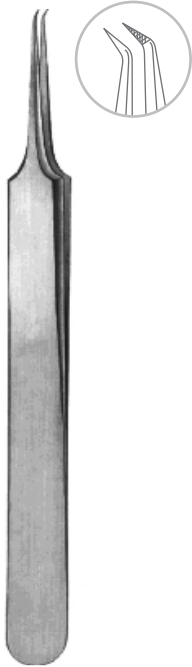

EI-848-11
Osher Iris Forcep
Very Fine Textured Jaws
Overall Length 11 cm (4 1/4")



EI-850-11
Foreign Body Forcep
Straight
Overall Length 8.5 cm (3 1/4")



EI-855-11
Jaffe Utility Forcep
Curved, Very Delicate
Smooth Jaws
Overall Length 11 cm (4 1/4")



EI-857-11
Castroviejo Capsule Forcep
Overall Length 11 cm (4 1/4")



EI-859-11
Arruga Capsule Forcep
Curved, Very Delicate
Overall Length 11 cm (4 1/4")

Eye Surgery Forceps
Augenchirurgie Pinzetten
Ojo Pinzas Cirugía
Pince de chirurgie oculaire
Eye Pinze Chirurgia



EI-861-11
Akahoshi Phaco PreChopper
Delicate Jaws With Sharp Tip
4.5 mm
Overall Length 11 cm (4 1/4")



EI-863-11
Ernest Nucleus Cracker
Extra Delicate Cross Action
Serrated Paddle Tip
Overall Length 11 cm (4 1/4")



EI-867-11
Dodick Nucleus Cracker
Cross Action, Longitudinally
Serrated Paddle Shaped Jaws
Overall Length 11 cm (4 1/4")



EI-869-10
Alfonso Nucleus Grasping Forcep
With Two Short Rows of Delicate
Interlocking Teeth
Overall Length 10.5 cm (4")

Eye Surgery Forceps
Augenchirurgie Pinzetten
Ojo Pinzas Cirugia
Pince de chirurgie oculaire
Eye Pinze Chirurgia

EVA

FORCEPS



EI-871-11
**Rosenwasser Donor
Lamella Inserting Forcep**
With Vaulted Shanks
Overall Length 11 cm (4 1/4")



EI-875-11
Dodick IOL Folding Forcep
For Short IOLs
Overall Length 11 cm (4 1/4")



EI-8EI-10
Livernois IOL Folding Forcep
Concave Jaw Surfaces, For Soft IOLs
Overall Length 11 cm (4 1/4")

Eye Surgery Forceps
Augenchirurgie Pinzetten
Ojo Pinzas Cirugía
Pince de chirurgie oculaire
Eye Pinze Chirurgia



EI-879-10
Steinert IOL Inserting Forcep
Conically Shaped Jaws
Overall Length 10 cm (4")



EI-882-10
Livernois IOL Holding Forcep
Straight, Highly Polished Round
Jaws For Holding Soft IOLs
Overall Length 10.5 cm (4")



EI-883-10
Livernois IOL Holding Forcep
Angled, Highly Polished Round
Jaws For Holding Soft IOLs
Overall Length 10.5 cm (4")

Eye Surgery Forceps
Augenchirurgie Pinzetten
Ojo Pinzas Cirugia
Pince de chirurgie oculaire
Eye Pinze Chirurgia

EVA

FORCEPS



EI-885-10
Livernois-McDonald IOL Inserting Forcep
Concave Jaws, 5.0 mm
Overall Length 10.5 cm (4")



EI-8EI-10
Faulkner Lens Holding Forcep
Round, Smooth Jaws
Overall Length 10 cm (4")



EI-889-10
Buratto IOL Inserting Forcep
Extra Delicate Highly Polished Convex Jaws
For Soft IOLs
Overall Length 10 cm (4")

Eye Surgery Forceps
Augenchirurgie Pinzetten
Ojo Pinzas Cirugía
Pince de chirurgie oculaire
Eye Pinze Chirurgia



EI-891-12
Bechert Lens Holding Forcep
Very Delicate Flat Jaws
Overall Length 12.5 cm (5")



EI-893-12
Kratz Lens Holding Forcep
Very Delicate Narrow Jaws
Overall Length 12.5 cm (5")



EI-895-11
Blaydes Lens Holding Forcep
Very Delicate Narrow Jaws
Angled 45°
Overall Length 11.5 cm (4 ½")



EI-897-12
Shepard Lens Holding Forcep
Gently Curved, Duckbill Shaped Jaws
Overall Length 12.5 cm (5")

Eye Surgery Forceps
Augenchirurgie Pinzetten
Ojo Pinzas Cirugia
Pince de chirurgie oculaire
Eye Pinze Chirurgia

EVA

FORCEPS

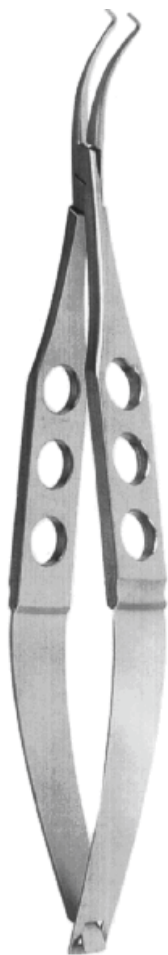

EI-899-12
Clayman Lens Holding Forcep
Gently Curved, Blades With
Delicately Angled Jaws
Overall Length 12.5 cm (5")

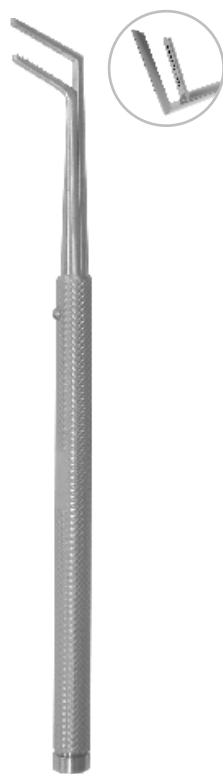

EI-900-10
Bangerter Muscle Clamp
With 10 Delicate Teeth
and Push Button
Overall Length 10 cm (4")



EI-901-01
Jameson Muscle Forcep
Right, With Slide Lock,
4 Teeth, Child Size
Overall Length 9.5 cm (3 ¾")

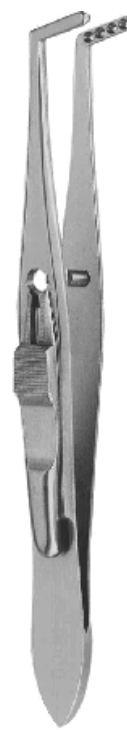

EI-901-02
Jameson Muscle Forcep
Left, With Slide Lock,
4 Teeth, Child Size
Overall Length 9.5 cm (3 ¾")

Eye Surgery Forceps
Augenchirurgie Pinzetten
Ojo Pinzas Cirugía
Pince de chirurgie oculaire
Eye Pinze Chirurgia



EI-903-01
Jameson Muscle Forcep
Right, With Slide Lock,
6 Teeth, Adult Size
Overall Length 10 cm (4")



EI-903-02
Jameson Muscle Forcep
Left, With Slide Lock,
6 Teeth, Adult Size
Overall Length 10 cm (4")



EI-905-20
Berke Ptosis Forcep
Longitudinally Grooved
Jaws, With Side Lock, 20 mm
Overall Length 11 cm (4 1/4")



EI-905-27
Berke Ptosis Forcep
Longitudinally Grooved
Jaws, With Side Lock, 27 mm
Overall Length 11 cm (4 1/4")

Eye Surgery Forceps
Augenchirurgie Pinzetten
Ojo Pinzas Cirugia
Pince de chirurgie oculaire
Eye Pinze Chirurgia

EVA

FORCEPS



EI-906-10
**Putterman-Muellers Muscle Conjunctival
Resection Ptosis Clamp**
With Slide Lock
Overall Length 10 cm (4")



EI-907-11
Watzke Sleeve Spreading Forcep
Jaw Length 10 mm
Overall Length 11.5 cm (4 1/2")



EI-908-10
Erhardt Lid Forcep
Overall Length 10.5 cm (4")

Eye Surgery Forceps
Augenchirurgie Pinzetten
Ojo Pinzas Cirugía
Pince de chirurgie oculaire
Eye Pinze Chirurgia

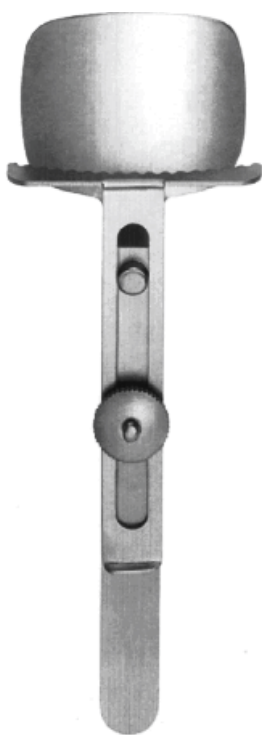

EI-910-09
Downes Lid Clamp
Overall Length 9.5 cm (3 ¾")



EI-912-08
Lambert Chalazion Forcep
Round Jaws, Ø 8.0 mm
Overall Length 9 cm (3 ½")



EI-912-12
Hunt Chalazion Forcep
Round Jaws, Ø 12.0 mm
Overall Length 9.5 cm (3 ¾")



EI-914-09
Baird Chalazion Forcep
Small, Oval Jaws, 11 x 8 mm
Overall Length 9.5 cm (3 ¾")

Ophthalmology Instruments
Ophthalmologie Instrumente
Ofthalmologia Instrumentos
Ophtalmologie Instruments
Ofthalmologia Strumenti

EVA

FORCEPS



EI-916-09
Francis Chalazion Forcep
Medium, Oval Jaws, 14 x 11 mm
Overall Length 9.5 cm (3 3/4")



Desmarres Chalazion Forcep
Overall Length 9 cm (3 1/2")

EI-918-09
Large, Oval Jaws, 20 x 13 mm

EI-919-09
Large, Oval Jaws, 25 x 13 mm



EI-920-09
Wies Chalazion Forcep
Grooved Upper Jaws
Overall Length 9.5 cm (3 3/4")



EI-921-09
Lordan Chalazion Forcep
Triangular Jaws
Overall Length 9.5 cm (3 3/4")

Eye Surgery Forceps
Augenchirurgie Pinzetten
Ojo Pinzas Cirugía
Pince de chirurgie oculaire
Eye Pinze Chirurgia



EI-922-01
Ayer Chalazion Forcep
Round Jaws, Ø 12.0 mm
Overall Length 9.5 cm (3 ¾")



EI-9EI-01
Desmarres Entropian Forcep
Right
Overall Length 10 cm (4")



EI-9EI-02
Desmarres Entropian Forcep
Left
Overall Length 10 cm (4")



EI-925-10
Collin Meibomian Gland
Expression Forcep
Ø 10 mm
Overall Length 10 cm (4")

Dissecting Forceps
Anatomische Pinzetten
Pinzas de disección
Pincès à dissection
Pinze per dissezione

EVA

FORCEPS



EI-940-17
UltraGrip™ TC Bonney Dissecting Forcep
1 x 2 Teeth
Overall Length 17.5 cm (7")

ULTRA GRIP X



EI-942-17
UltraGrip™ TC Gerald Dissecting Forcep
1 x 2 Teeth
Overall Length 17.5 cm (7")

ULTRA GRIP X



EI-944-15
UltraGrip™ TC Gillies Dissecting Forcep
1 x 2 Teeth
Overall Length 15.5 cm (6")

ULTRA GRIP X



Dissecting Forceps
Anatomische Pinzetten
Pinzas de disección
Pincès à dissection
Pinze per dissezione



ULTRA GRIP[™]

EI-946-15
UltraGrip™ TC McIndoe Dressing Forcep
Overall Length 15 cm (6")



EI-950-16
16 cm (6 ¼")



EI-950-18
18 cm (7")

ULTRA GRIP[™]

UltraGrip™ TC Semken Dissecting Forcep
1 x 2 Teeth



EI-952-16
16 cm (6 ¼")



EI-952-18
18 cm (7")

ULTRA GRIP[™]

UltraGrip™ TC Micro-Semken Dissecting Forcep
1 x 2 Teeth



ULTRA GRIP[™]

EI-956-12
UltraGrip™ TC Adson-Brown Dissecting Forcep
Overall Length 12 cm (4 ¾")



Dissecting Forceps
Anatomische Pinzetten
Pinzas de disección
Pincers à dissection
Pinze per dissezione

EVA

FORCEPS

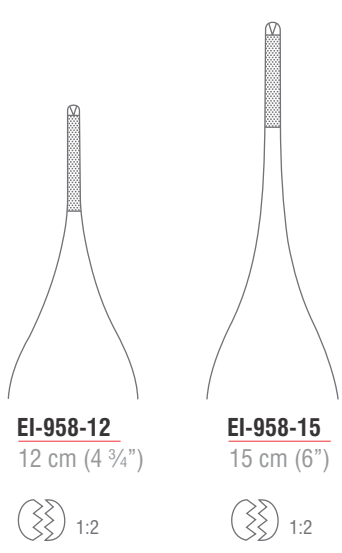

EI-958-12
12 cm (4 3/4")

EI-958-15
15 cm (6")



ULTRA GRIP[™]

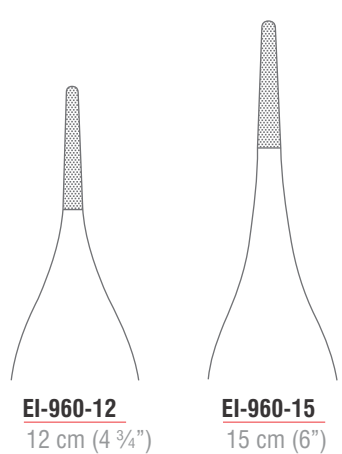

EI-960-12
12 cm (4 3/4")

EI-960-15
15 cm (6")

ULTRA GRIP[™]

UltraGrip™ TC Micro-Adson Dissecting Forcep
1 x 2 Teeth

UltraGrip™ TC Adson Dressing Forcep

Dissecting Forceps
Anatomische Pinzetten
Pinzas de disección
Pinces à dissection
Pinze per dissezione



UltraGrip™ TC Adson Dissecting Forcep
1 x 2 Teeth

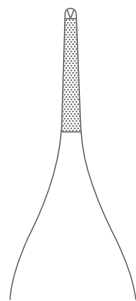

EI-962-12
12 cm (4 ¾")

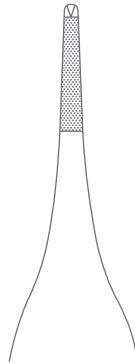

EI-962-15
15 cm (6")



ULTRA GRIP X™



UltraGrip™ TC Cushing Dressing Forcep
Straight



EI-966-17
17.5 cm (7")



EI-966-17
21 cm (8 ¼")

ULTRA GRIP X™

Dissecting Forceps
Anatomische Pinzetten
Pinzas de disección
Pincès à dissection
Pinze per dissezione



ULTRA GRIP[™]

EI-967-17
UltraGrip™ TC Cushing Dressing Forcep
Angled
Overall Length 17 cm (6 3/4")



ULTRA GRIP[™]

EI-969-17
UltraGrip™ TC Cushing-Taylor Dressing Forcep
Bayonet Shaped
Overall Length 18.5 cm (7 1/4")



EI-972-15
16 cm (6 1/4")



EI-972-18
18.5 cm (7 1/4")

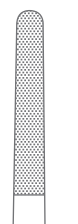

EI-972-20
20 cm (8")

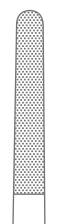

EI-972-23
23 cm (9")

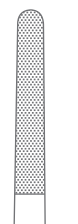

EI-972-25
25 cm (9 3/4")

ULTRA GRIP[™]

UltraGrip™ TC Potts-Smith Dressing Forcep

FORCEPS

Dissecting Forceps
Anatomische Pinzetten
Pinzas de disección
Pinces à dissection
Pinze per dissezione



EI-974-14
14.5 cm (5 ¾")



EI-974-16
16 cm (6 ¼")



EI-974-18
18 cm (7")



EI-974-20
20 cm (8")



EI-974-25
25 cm (9 ¾")



ULTRA GRIP[™]

UltraGrip™ TC Oehler Dissecting Forcep
1 x 2 Teeth



ULTRA GRIP[™]

EI-9EI-17
UltraGrip™ TC Ferris-Smith Dissecting Forcep
2 x 3 Teeth
Overall Length 17.5 cm (7")



EI-980-15
15 cm (6")



EI-980-23
23 cm (9")

ULTRA GRIP[™]



UltraGrip™ TC Wangenstein Dressing Forcep

Dissecting Forceps
Anatomische Pinzetten
Pinzas de disección
Pincès à dissection
Pinze per dissezione

EVA

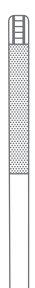

FORCEPS



		
EI-990-16	EI-990-20	EI-990-24
1.6 mm	1.6 mm	1.6 mm
16 cm (6 ¼")	20 cm (8")	24.5 cm (9 ¾")

ULTRA GRIP



		
EI-992-16	EI-992-20	EI-992-24
2.0 mm	2.0 mm	2.0 mm
16 cm (6 ¼")	20 cm (8")	24.5 cm (9 ¾")

ULTRA GRIP

UltraGrip™ TC Micro DeBakey Atraumatic Forceps

UltraGrip™ TC DeBakey Atraumatic Forceps

Dissecting Forceps
Anatomische Pinzetten
Pinzas de disección
Pincès à dissection
Pinze per dissezione



UltraGrip™ TC Jaboma Forcep
Overall Length 18 cm (7")



EI-994-18
Straight



EI-996-18
Straight
1 x 2 Teeth



EI-997-18
UltraGrip™ TC Jaboma Forcep
1 x 2 Teeth, Angled
Overall Length 18 cm (7")

Clip Applying Forceps, Vessel Clips
 Clip-Anlegepinzette, Gefäßclips
 Pinzas para aplicar clips
 Pincers pour poser les clips vasculaires, Clips vasculaires
 Pinze per applicazione clips vascolari



EI-010-14
Biemer Clamp Applying Forcep
 Without Lock
 Overall Length 14.5 cm (5 ¾")

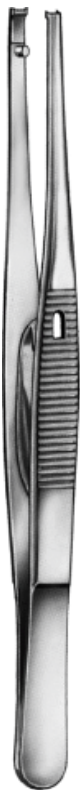

EI-012-14
Biemer Clamp Applying Forcep
 With Lock
 Overall Length 14.5 cm (5 ¾")



Biemer Vessel Clamp



EI-016-14
 14 mm
 Opening : 4 mm
 Jaw Length : 4 mm
 Closing Pressure : 30 - 40 gr



EI-018-17
 17 mm
 Opening : 7 mm
 Jaw Length : 5 mm
 Closing Pressure : 30 - 40 gr



EI-020-17
 17 mm
 Opening : 7 mm
 Jaw Length : 5 mm
 Closing Pressure : 20 - 25 gr

Vessel Clips, Approximators
 Gefäßclips, Approximatoren
 Clips vasculares, Aproximadores
 Clips vasculaires, Approximateurs
 Clip vascolari, Approssimatori



EI-024-17
Biemer-Mueller Approximator
 17 mm, Straight, Wide
 Opening : 5 mm
 Jaw Length : 9 mm
 Closing Pressure : 25 - 30 gr



EI-025-17
Biemer-Mueller Approximator
 17 mm, Angled, Wide
 Opening : 5 mm
 Jaw Length : 9 mm
 Closing Pressure : 25 - 30 gr

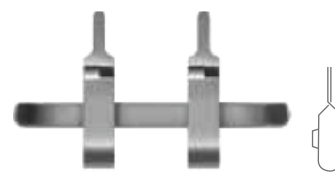

EI-026-13
Biemer-Mueller Approximator
 13 mm, Straight, Narrow
 Opening : 3 mm
 Jaw Length : 4.5 mm
 Closing Pressure : 25 - 30 gr



EI-026-17
Biemer-Mueller Approximator
 17 mm, Straight, Narrow
 Opening : 5 mm
 Jaw Length : 9 mm
 Closing Pressure : 25 - 30 gr



EI-027-13
Biemer-Mueller Approximator
 13 mm, Angled, Narrow
 Opening : 3 mm
 Jaw Length : 4.5 mm
 Closing Pressure : 25 - 30 gr



EI-027-17
Biemer-Mueller Approximator
 17 mm, Straight, Narrow
 Opening : 5 mm
 Jaw Length : 9 mm
 Closing Pressure : 25 - 30 gr



Mueller Approximator
 Overall Length 17 mm



EI-030-01
 Ø 1.0 mm
 Closing Pressure
 25 - 30 gr



EI-030-02
 Ø 2.0 mm
 Closing Pressure
 25 - 30 gr

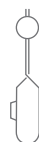

EI-030-03
 Ø 3.0 mm
 Closing Pressure
 25 - 30 gr

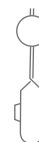

EI-030-04
 Ø 4.0 mm
 Closing Pressure
 25 - 30 gr

Approximators
Approximatoren
Aproximadores
Approximateurs
Approssimatori

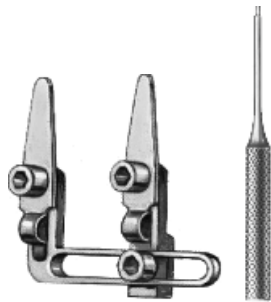

EI-040-00
Nerve Approximator
Complete with Key
Standard



EI-040-01
Key For Approximator



EI-040-02
Nerve Approximator
Approximator Only
Standard

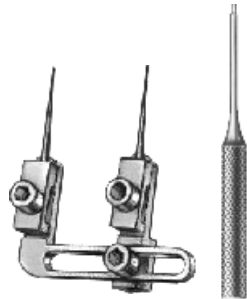

EI-044-00
Nerve Approximator
Complete with Key
Needles Exchangeable by
Mean of Key
Standard

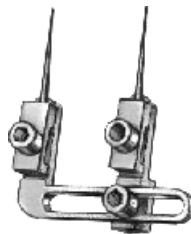

EI-044-02
Nerve Approximator
Approximator With Needles Only
Standard



EI-044-04
Spare Needle

Clip Applying Forceps, Vessel Clips
 Clip-Anlegezangen, Bulldogklemmen, Gefäßclips
 Pinzas para aplicar clips, Clips vasculares
 Pinces pour poser micro-clips, Clips vasculaires
 Pinze per applicare clips vascolari, Clip vascolari



EI-046-14
Clip Applying Forcep
 With Ratchet
 Overall Length 14.5 cm (5 3/4")



EI-049-18
Clip Applying Forcep
 Bayonet Shaped, With Ratchet
 Overall Length 18.5 cm (7 1/4")

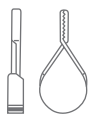

EI-050-04
 13 mm
 Jaw Size : 4.0 x 0.75 mm
 Closing Pressure : 60 gr

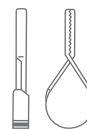

EI-050-06
 15 mm
 Jaw Size : 6.0 x 1.0 mm
 Closing Pressure : 85 gr



Mini Vessel Clip

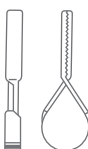

EI-050-08
 17 mm
 Jaw Size : 8.0 x 2.0 mm
 Closing Pressure : 100 gr

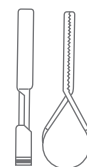

EI-050-10
 20 mm
 Jaw Size : 10.0 x 2.0 mm
 Closing Pressure : 125 gr

Vessel Clips
 Gefäßclips
 Clips vasculares
 Clips vasculaires
 Clip vascolari

"A" or "V" Pattern?

The "V" pattern is the all-purpose clamp, used on almost all veins and arteries.

The "A" pattern, available in all sizes, is designed for thick-walled vessels and slippery arteries.

The slight curve at the tips of the "A" pattern jaws provide extra security against slippage.

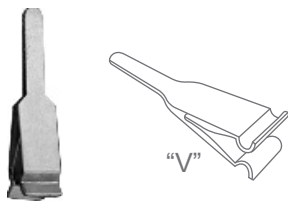

Acland Micro Vessel Clamp
 For Vessels
 Single

EI-052-08
 Overall Length: 8 mm
 Vessel Size Ø 0.4 - 1.0 mm
 Clamping Force: 10 - 14 Gram

EI-052-11
 Overall Length: 11 mm
 Vessel Size Ø 0.6 - 1.5 mm
 Clamping Force: 17 - 23 Gram

EI-052-14
 Overall Length: 14 mm
 Vessel Size Ø 0.1 - 2.25 mm
 Clamping Force: 35 - 45 Gram

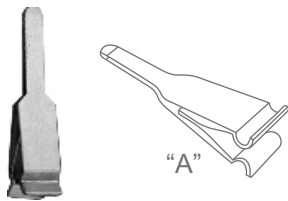

Acland Micro Vessel Clamp
 For Vessels
 Single

EI-052-17
 Overall Length: 17 mm
 Vessel Size Ø 1.5 - 3.5 mm
 Clamping Force: 60 - 75 Gram

EI-052-25
 Overall Length: 25 mm
 Vessel Size Ø 2.0 - 5.0 mm
 Clamping Force: 120 - 140Gram

EI-053-08
 Overall Length: 8 mm
 Vessel Size Ø 0.4 - 1.0 mm
 Clamping Force: 10 - 14 Gram

EI-053-11
 Overall Length: 11 mm
 Vessel Size Ø 0.6 - 1.5 mm
 Clamping Force: 17 - 23 Gram

EI-053-14
 Overall Length: 14 mm
 Vessel Size Ø 0.1 - 2.25 mm
 Clamping Force: 35 - 45 Gram

EI-053-17
 Overall Length: 17 mm
 Vessel Size Ø 1.5 - 3.5 mm
 Clamping Force: 60 - 75 Gram

EI-053-25
 Overall Length: 25 mm
 Vessel Size Ø 2.0 - 5.0 mm
 Clamping Force: 120 - 140 Gram

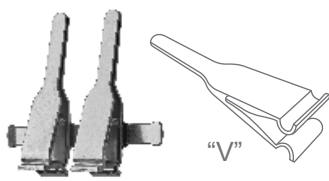

Acland Micro Vessel Clamp
 For Vessels
 Double

EI-054-08
 Overall Length: 8 mm
 Vessel Size Ø 0.4 - 1.0 mm
 Clamping Force: 10 - 14 Gram

EI-054-11
 Overall Length: 11 mm
 Vessel Size Ø 0.6 - 1.5 mm
 Clamping Force: 17 - 23 Gram

EI-054-14
 Overall Length: 14 mm
 Vessel Size Ø 0.1 - 2.25 mm
 Clamping Force: 35 - 45 Gram

EI-054-17
 Overall Length: 17 mm
 Vessel Size Ø 1.5 - 3.5 mm
 Clamping Force: 60 - 75 Gram

EI-054-25
 Overall Length: 25 mm
 Vessel Size Ø 2.0 - 5.0 mm
 Clamping Force: 120 - 140Gram

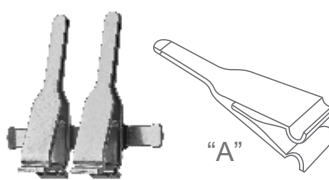

Acland Micro Vessel Clamp
 For Vessels
 Double

EI-055-08
 Overall Length: 8 mm
 Vessel Size Ø 0.4 - 1.0 mm
 Clamping Force: 10 - 14 Gram

EI-055-11
 Overall Length: 11 mm
 Vessel Size Ø 0.6 - 1.5 mm
 Clamping Force: 17 - 23 Gram

EI-055-14
 Overall Length: 14 mm
 Vessel Size Ø 0.1 - 2.25 mm
 Clamping Force: 35 - 45 Gram

EI-055-17
 Overall Length: 17 mm
 Vessel Size Ø 1.5 - 3.5 mm
 Clamping Force: 60 - 75 Gram

EI-055-25
 Overall Length: 25 mm
 Vessel Size Ø 2.0 - 5.0 mm
 Clamping Force: 120 - 140 Gram

Vessel Clips
Gefäßclips
Clips vasculares
Clips vasculaires
Clip vascolari

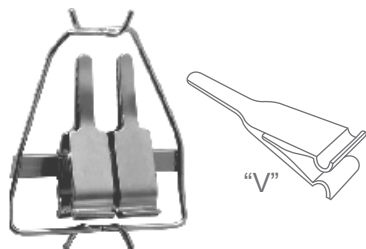

EI-056-08
Overall Length: 8 mm
Vessel Size Ø 0.4 - 1.0 mm
Clamping Force: 10 - 14 Gram

EI-056-11
Overall Length: 11 mm
Vessel Size Ø 0.6 - 1.5 mm
Clamping Force: 17 - 23 Gram

EI-056-14
Overall Length: 14 mm
Vessel Size Ø 0.1 - 2.25 mm
Clamping Force: 35 - 45 Gram

Acland Micro Vessel Clamp
For Vessels
Double, With Frame

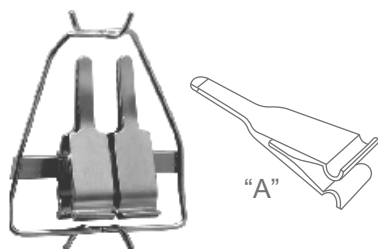

EI-057-08
Overall Length: 8 mm
Vessel Size Ø 0.4 - 1.0 mm
Clamping Force: 10 - 14 Gram

EI-057-11
Overall Length: 11 mm
Vessel Size Ø 0.6 - 1.5 mm
Clamping Force: 17 - 23 Gram

EI-057-14
Overall Length: 14 mm
Vessel Size Ø 0.1 - 2.25 mm
Clamping Force: 35 - 45 Gram

Acland Micro Vessel Clamp
For Vessels
Double, With Frame



EI-058-00
Acland Clamp Applying Forcep
Overall Length 14.5 cm (5 3/4")



Bulldog Clamps
Bulldogklemmen
Clamps Bulldog
Clamps Bulldog
Pinze Bulldog



Dieffenbach Bulldog Clamp
Overall Length 6 cm (2 1/4")

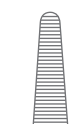

EI-060-06
Straight

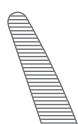

EI-061-06
Curved



Dieffenbach Bulldog Clamp



EI-062-03
Straight
3.5 cm (1 1/2")



EI-062-05
Straight
5 cm (2")



EI-063-03
Curved
3.5 cm (1 1/2")



EI-063-05
Curved
5 cm (2")



John-Hopkins Bulldog Clamp

Codes	Overall Length	Jaw Length
EI-065-35	3.5 cm (1 1/2")	12 mm
EI-065-50	5 cm (2")	17 mm
EI-065-55	5.5 cm (2 1/8")	25 mm
EI-065-65	6.5 cm (2 1/2")	30 mm
EI-065-70	7 cm (2 3/4")	33 mm
EI-065-80	8 cm (3 1/4")	42 mm
EI-065-90	9 cm (3 1/2")	52 mm



EI-067-24
John-Hopkins Clamp Applying Forcep
Overall Length 24 cm (9 1/2")

Bulldog Clamps
Bulldogklemmen
Clamps Bulldog
Clamps Bulldog
Pinze Bulldog



Diethrich Bulldog Clamp



EI-080-45
Straight
45 mm, 8 mm

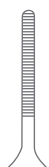

EI-080-50
Straight
50 mm, 12 mm

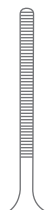

EI-080-60
Straight
60 mm, 20 mm



EI-081-40
Angled
45 mm, 8 mm

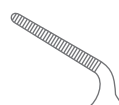

EI-081-45
Angled
50 mm, 12 mm

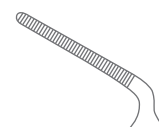

EI-081-50
Angled
60 mm, 20 mm



DeBakey-Diethrich Atrauma Bulldog Clamp

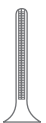

EI-084-10
Straight
45 mm, 10 mm

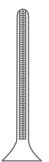

EI-084-14
Straight
50 mm, 14 mm

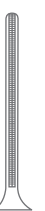

EI-084-20
Straight
60 mm, 20 mm

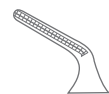

EI-085-10
Angled
35 mm, 10 mm



EI-085-14
Angled
45 mm, 14 mm

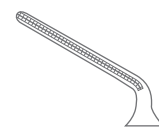

EI-085-20
Angled
50 mm, 20 mm

Bulldog Clamps
Bulldogklemmen
Clamps Bulldog
Clamps Bulldog
Pinze Bulldog

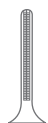

EI-084-10 T
Straight
45 mm, 10 mm

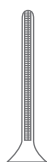

EI-084-14 T
Straight
50 mm, 14 mm

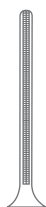

EI-084-20 T
Straight
60 mm, 20 mm

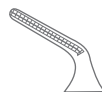

EI-085-10 T
Angled
35 mm, 10 mm



EI-085-14 T
Angled
45 mm, 14 mm

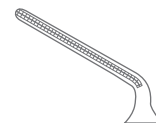

EI-085-20 T
Angled
50 mm, 20 mm

DeBakey-Diethrich Atrauma Bulldog Clamp
Titanium



TITANIUM

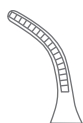

EI-0EI-10
35 mm, 10 mm

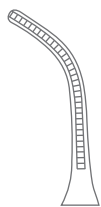

EI-0EI-20
50 mm, 10 mm



EI-089-35
35 mm, 10 mm

EI-089-40
40 mm, 10 mm

DeBakey-Diethrich Atrauma Bulldog Clamp
Curved

DeBakey-Hess Bulldog Clamp

Bulldog Clamps
Bulldogklemmen
Clamps Bulldog
Clamps Bulldog
Pinze Bulldog



Mini-Glover Vena Atrauma Bulldog Clamp
Titanium



EI-090-30 T
Straight
30 mm, 9 mm

EI-090-35 T
Straight
35 mm, 13 mm

EI-090-40 T
Straight
40 mm, 14 mm

EI-090-50 T
Straight
50 mm, 23 mm

EI-091-30 T
Gently Curved
30 mm, 9 mm

EI-091-35 T
Gently Curved
35 mm, 13 mm

EI-091-40 T
Gently Curved
40 mm, 14 mm

EI-091-50 T
Gently Curved
50 mm, 23 mm

EI-093-30 T
Strongly Curved
30 mm, 9 mm

EI-093-35 T
Strongly Curved
35 mm, 13 mm

EI-093-40 T
Strongly Curved
40 mm, 14 mm

EI-093-50 T
Strongly Curved
50 mm, 23 mm

Bulldog Clamps
Bulldogklemmen
Clamps Bulldog
Clamps Bulldog
Pinze Bulldog



Mini-Glover Arteria Atrauma Bulldog Clamp
Titanium



EI-096-30 T
Straight
30 mm, 9 mm



EI-096-35 T
Straight
35 mm, 13 mm



EI-096-40 T
Straight
40 mm, 14 mm



EI-096-50 T
Straight
50 mm, 23 mm



EI-097-30 T
Gently Curved
30 mm, 9 mm



EI-097-35 T
Gently Curved
35 mm, 13 mm



EI-097-40 T
Gently Curved
40 mm, 14 mm



EI-097-50 T
Gently Curved
50 mm, 22 mm



EI-099-30 T
Strongly Curved
30 mm, 9 mm



EI-099-35 T
Strongly Curved
35 mm, 14 mm



EI-099-40 T
Strongly Curved
40 mm, 15 mm



EI-099-50 T
Strongly Curved
50 mm, 21 mm

Haemostatic Forceps
Arterienklemmen
Pinzas hemostáticas
Pinces hémostatiques
Pinze emostatiche



Pean Haemostatic Forcep



EI-110-14
Straight
14.5 cm (5 3/4")



EI-110-16
Straight
16 cm (6 1/4")

EI-111-14
Curved
14.5 cm (5 3/4")

EI-111-16
Curved
16 cm (6 1/4")

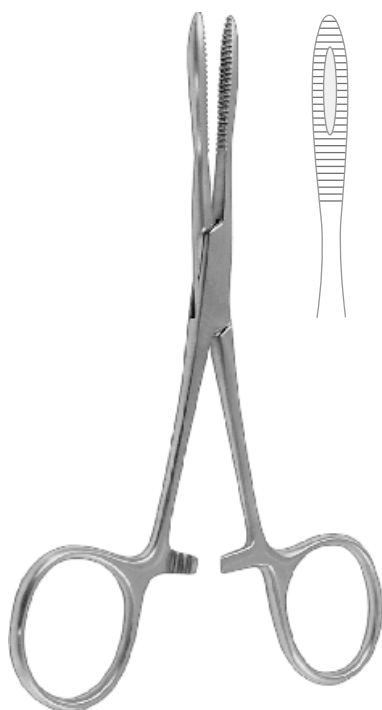

EI-112-13
Korenlein Haemostatic Forcep
Overall Length 13 cm (5")



Haemostatic Forceps
Arterienklemmen
Pinzas hemostáticas
Pinces hémostatiques
Pinze emostatiche

EVA



Spencer-Wells Haemostatic Forcep

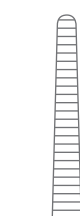

EI-114-13
13 cm (5")



EI-114-14
14.5 cm (5 3/4")



EI-114-15
15.5 cm (6")



EI-114-18
18.5 cm (7 1/4")



EI-114-20
20 cm (8")



EI-115-13
13 cm (5")



EI-115-14
14 cm (5 1/2")



EI-115-15
15 cm (6")



EI-115-18
18 cm (7")



EI-115-20
20 cm (8")



EI-120-13
Chaput Haemostatic Forcep
2 x 3 Teeth
Overall Length 12.5 cm (5")



EI-122-13
Tuffier Haemostatic Forcep
4 x 5 Teeth
Overall Length 12.5 cm (5")



Haemostatic Forceps, Organ Grasping Forceps
Arterienklemmen, Organfasszangen
Pinzas hemostáticas, Pinzas para sacar órganos
Pincés hémostatiques, Pincés pour saisir organes
Pinze emostatiche, Pinze per afferrare organi



Atrauma Organ Grasping / Haemorrhoidal Forcep



EI-126-25
25 cm (9 3/4")



EI-126-26
26 cm (10 1/4")

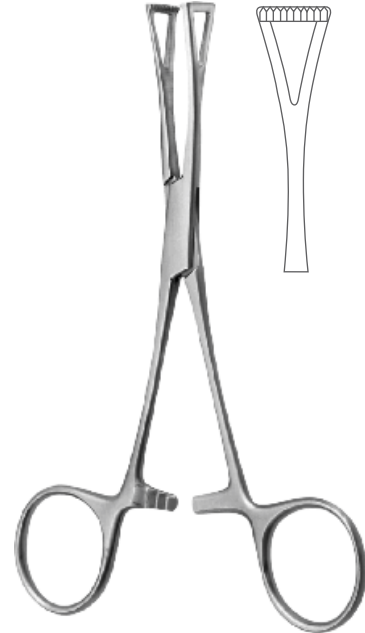

EI-128-14
Collin Organ Grasping Forcep
Overall Length 14 cm (5 1/2")



EI-130-17
Collin Tumor Grasping Forcep
Overall Length 17 cm (6 3/4")



Pennington Organ Grasping Forcep



EI-1EI-15
15.5 cm (6")

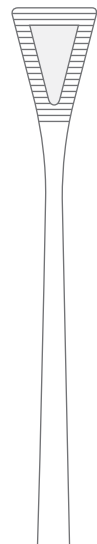

EI-1EI-20
21 cm (8 1/4")

Haemostatic Forceps
Arterienklemmen
Pinzas hemostáticas
Pinces hémostatiques
Pinze emostatiche



EI-136-15
Pratt Haemostatic Forcep
Overall Length 15 cm (6")

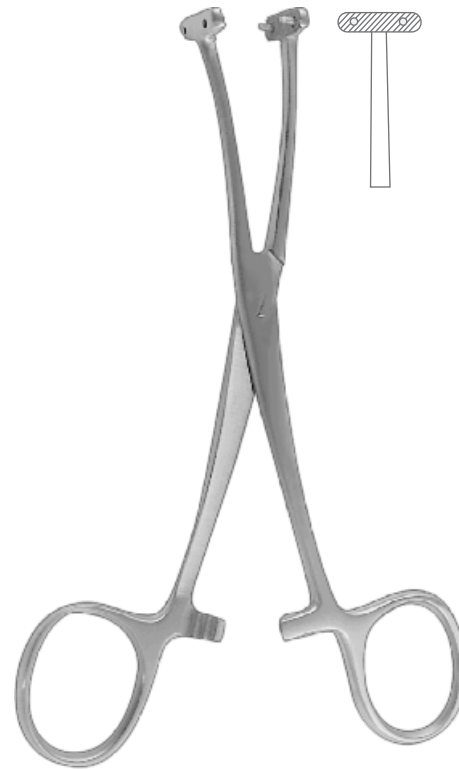

EI-138-14
Martel-Rees Facelift Forcep
Overall Length 13.5 cm (5 1/4")



Hartmann Haemostatic Forcep



EI-140-10
Straight
10 cm (4")



EI-141-10
Curved
9.5 cm (3 3/4")



EI-142-10
Straight
1 x 2 Teeth
10 cm (4")



EI-143-10
Curved
1 x 2 Teeth
9.5 cm (3 3/4")

Haemostatic Forceps
Arterienklemmen
Pinzas hemostáticas
Pincès hémostatiques
Pinze emostatiche

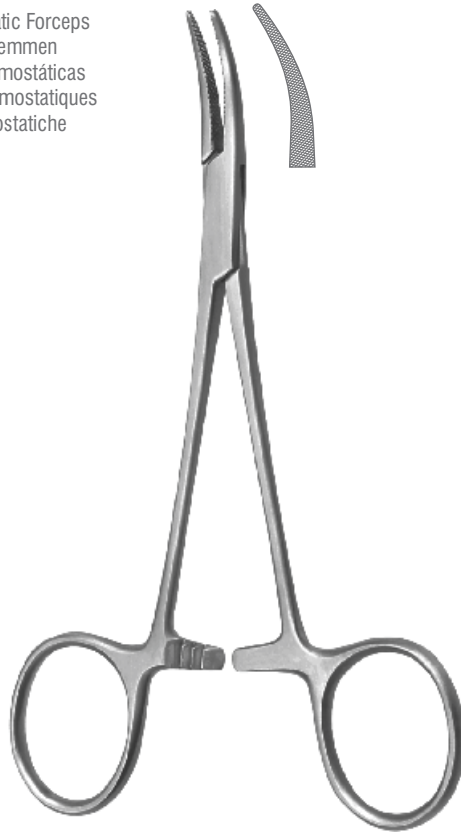

EI-146-12
Haemostatic Forcep
Cross Serrated Jaw
Overall Length 12.5 cm (5")



EI-148-08
Carrel Haemostatic Forcep
Overall Length 8.5 cm (3 1/4")



EI-150-08
Terrier Haemostatic Forcep
1 x 2 Teeth
Overall Length 8.5 cm (3 1/4")



Haemostatic Forceps
Arterienklemmen
Pinzas hemostáticas
Pincès hémostatiques
Pinze emostatiche



Halsted-Mosquito Haemostatic Forcep



EI-160-12
Straight
12.5 cm (4 3/4")



EI-160-14
Straight
14.5 cm (5 1/2")



EI-161-12
Curved
12 cm (4 3/4")



EI-161-14
Curved
14 cm (5 1/2")



EI-162-12
Straight
1 x 2 Teeth
12.5 cm (4 3/4")



EI-162-14
Straight
1 x 2 Teeth
14.5 cm (5 1/2")



EI-163-12
Curved
1 x 2 Teeth
12 cm (4 3/4")



EI-163-14
Curved
1 x 2 Teeth
14 cm (5 1/2")



Micro-Mosquito Haemostatic Forcep



EI-170-10
Straight
10 cm (4")



EI-170-12
Straight
12 cm (4 3/4")



EI-171-10
Curved
9.5 cm (3 3/4")



EI-171-12
Curved
11.5 cm (4 1/2")



EI-172-10
Straight
1 x 2 Teeth
10 cm (4")



EI-172-12
Straight
1 x 2 Teeth
12 cm (4 3/4")



EI-1EI-10
Curved
1 x 2 Teeth
10 cm (4")



EI-1EI-12
Curved
1 x 2 Teeth
12 cm (4 3/4")



Haemostatic Forceps
Arterienklemmen
Pinzas hemostáticas
Pinces hémostatiques
Pinze emostatiche



Halsted-Mosquito Haemostatic Forcep



EI-176-18
Straight
18.5 cm (7 1/4")



EI-176-21
Straight
21 cm (8 1/4")



EI-1EI-18
Curved
18 cm (7")



EI-1EI-21
Curved
20.5 cm (8")



EI-1EI-18
Straight
1 x 2 Teeth
18.5 cm (7 1/4")



EI-1EI-21
Straight
1 x 2 Teeth
21 cm (8 1/4")



EI-179-18
Curved
1 x 2 Teeth
18 cm (7")



EI-179-21
Curved
1 x 2 Teeth
21 cm (8")



Providence-Hospital Haemostatic Forcep



EI-182-14
Straight
14 cm (5 1/2")



EI-183-14
Curved
14 cm (5 1/2")

Haemostatic Forceps
Arterienklemmen
Pinzas hemostáticas
Pincers hémostatiques
Pinze emostatiche



Leriche Haemostatic Forcep



EI-184-15
Straight
15.5 cm (6")



EI-185-15
Curved
15 cm (6")



EI-186-15
Straight
1 x 2 Teeth
15.5 cm (6")



EI-1EI-15
Curved
1 x 2 Teeth
15 cm (6")



Kelly Haemostatic Forcep



EI-200-14
14.5 cm (5 3/4")



EI-201-14
14.5 cm (5 3/4")

Haemostatic Forceps
Arterienklemmen
Pinzas hemostáticas
Pinces hémostatiques
Pinze emostatiche



EI-202-16
Straight
16 cm (6 ¼")

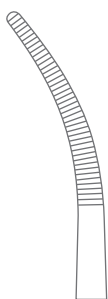

EI-203-16
Curved
15.5 cm (6")

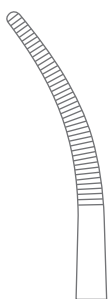

Kelly-Rankin Haemostatic Forcep



EI-210-14
Straight
14.5 cm (5 ¾")



EI-211-14
Curved
14 cm (5 ½")



EI-212-14
Straight
1 x 2 Teeth
14.5 cm (5 ¾")



EI-213-14
Curved
1 x 2 Teeth
14 cm (5 ½")



Crile Haemostatic Forcep



Haemostatic Forceps
Arterienklemmen
Pinzas hemostáticas
Pinces hémostatiques
Pinze emostatiche



EI-214-16
Straight

EI-215-16
Curved

Crile-Rankin Haemostatic Forcep
Overall Length 17 cm (6 3/4")

Haemostatic Forceps
Arterienklemmen
Pinzas hemostáticas
Pinces hémostatiques
Pinze emostatiche

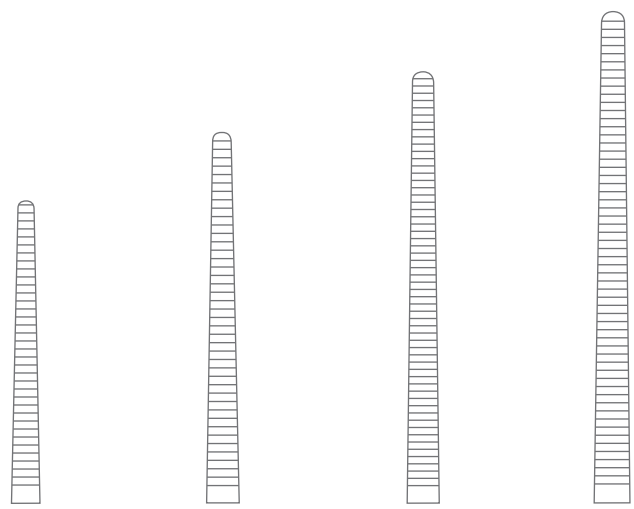

EI-220-14
14.5 cm (5 ¾")

EI-220-16
16.5 cm (6 ½")

EI-220-18
18.5 cm (7 ¼")

EI-220-20
20.5 cm (8")



Rochester-Pean Haemostatic Forcep
Straight



EI-220-22
22.5 cm (8 ¾")



EI-220-24
24.5 cm (9 ¾")



EI-220-26
26 cm (10 ¼")



EI-220-30
30.5 cm (12")

Haemostatic Forceps
 Arterienklemmen
 Pinzas hemostáticas
 Pinces hémostatiques
 Pinze emostatiche

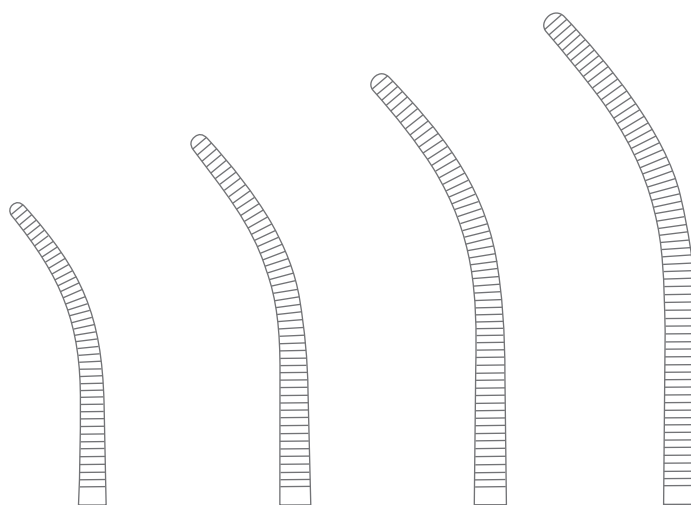

EI-221-14
 14 cm (5 1/2")

EI-221-16
 16 cm (6 1/4")

EI-221-18
 18 cm (7")

EI-221-20
 20 cm (8")



Rochester-Pean Haemostatic Forcep
 Curved

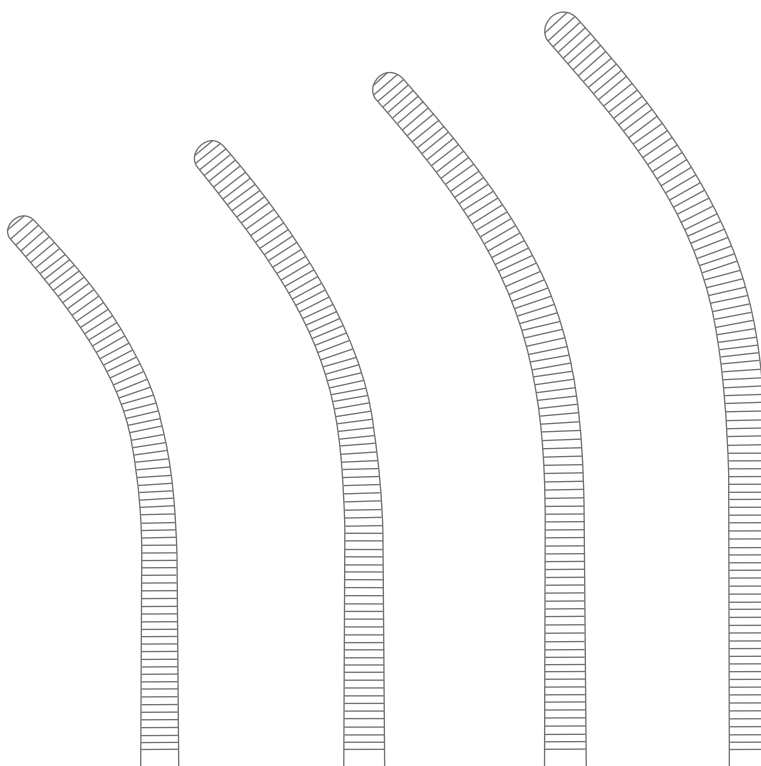

EI-221-22
 22 cm (8 3/4")

EI-221-24
 24 cm (9 1/2")

EI-221-26
 25.5 cm (10")

EI-221-30
 30 cm (11 3/4")

Haemostatic Forceps
Arterienklemmen
Pinzas hemostáticas
Pinces hémostatiques
Pinze emostatiche

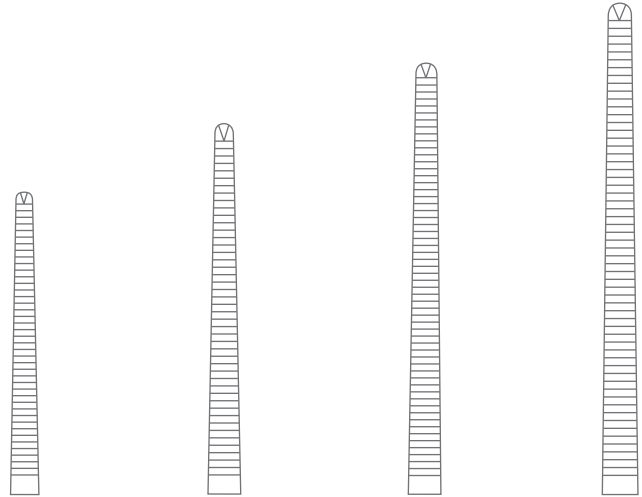

EI-230-14
14.5 cm (5 3/4")

EI-230-16
16.5 cm (6 1/2")

EI-230-18
18.5 cm (7 1/4")

EI-230-20
20.5 cm (8")



Ochsner-Kocher Haemostatic Forcep
Straight, 1 x 2 Teeth

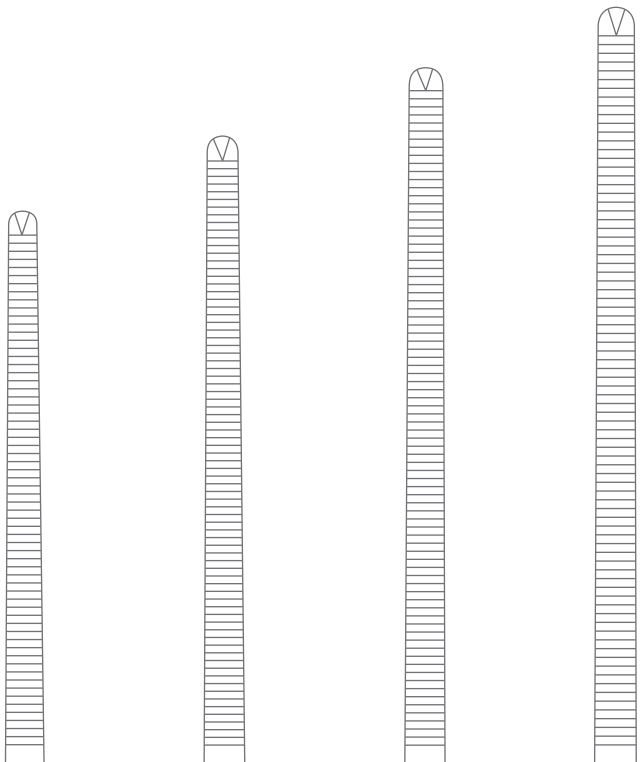

EI-230-22
22.5 cm (8 3/4")

EI-230-24
24.5 cm (9 3/4")

EI-230-26
26 cm (10 1/4")

EI-230-30
30.5 cm (12")

Haemostatic Forceps
Arterienklemmen
Pinzas hemostáticas
Pincès hémostatiques
Pinze emostatiche

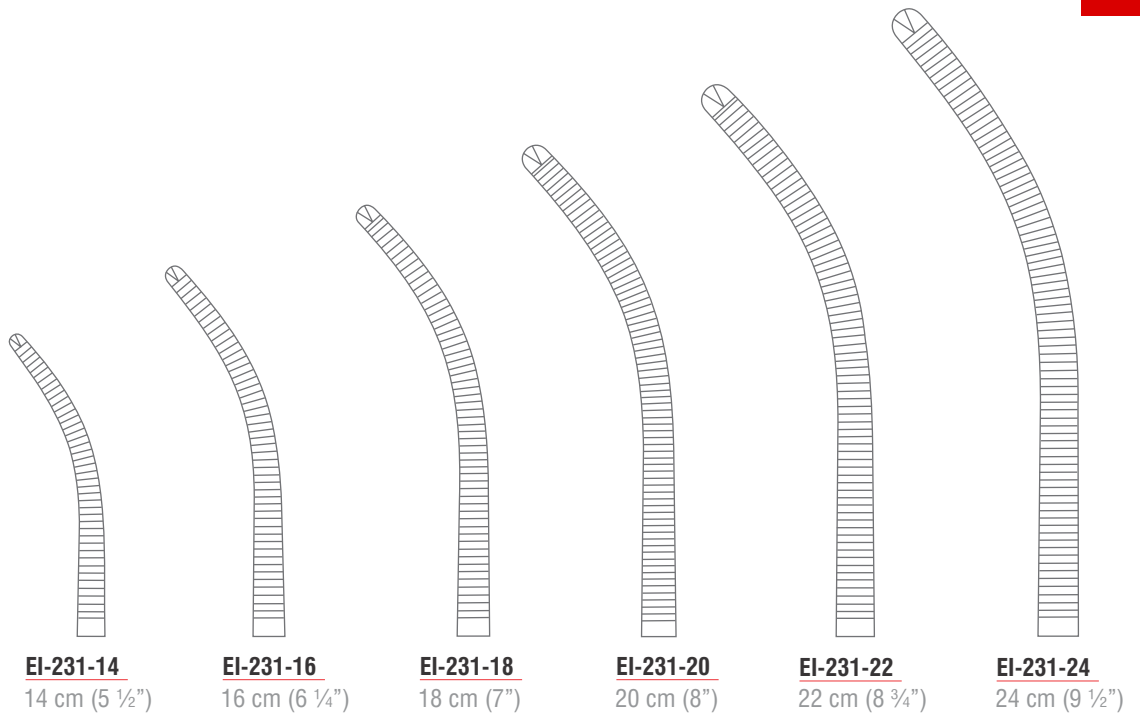

Ochsner-Kocher Haemostatic Forcep
Curved, 1 x 2 Teeth

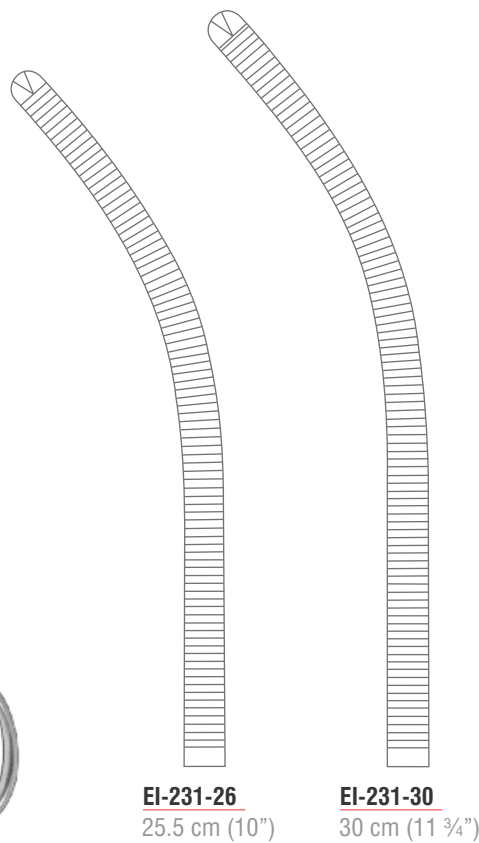

1:2

Haemostatic Forceps
Arterienklemmen
Pinzas hemostáticas
Pinces hémostatiques
Pinze emostatiche



EI-2EI-14
Straight

EI-235-14
Curved

Rochester-Ochsner Haemostatic Forcep
1 x 2 Teeth
Overall Length 14 cm (5 1/2")



EI-236-15
Straight

EI-2EI-15
Curved

Kocher Haemostatic Forcep
1 x 2 Teeth
Overall Length 15 cm (6")



Haemostatic Forceps
Arterienklemmen
Pinzas hemostáticas
Pinces hémostatiques
Pinze emostatiche



Pean-Nippon Haemostatic Forcep



EI-240-14
Straight
14.5 cm (5 ¾")



EI-240-16
Straight
16.5 cm (6 ½")



EI-240-18
Straight
18.5 cm (7 ¼")



EI-241-14
Curved
14 cm (5 ½")



EI-241-16
Curved
16 cm (6 ¼")



EI-241-18
Curved
18 cm (7")

Haemostatic Forceps
Arterienklemmen
Pinzas hemostáticas
Pinces hémostatiques
Pinze emostatiche



Kocher-Nippon Haemostatic Forcep
1 x 2 Teeth



EI-242-14
Straight
14.5 cm (5 3/4")



EI-242-16
Straight
16.5 cm (6 1/2")



EI-242-18
Straight
18.5 cm (7 1/4")



EI-243-14
Curved
14.5 cm (5 3/4")



EI-243-16
Curved
16 cm (6 1/4")



EI-243-18
Curved
18 cm (7")

Haemostatic Forceps
Arterienklemmen
Pinzas hemostáticas
Pincès hémostatiques
Pinze emostatiche



Pean (Delicate) Haemostatic Forcep



EI-246-13
Straight
13.5 cm (5 3/4")



EI-246-14
Straight
14.5 cm (5 3/4")



EI-246-17
Straight
17 cm (6 3/4")



EI-247-13
Curved
13 cm (5")



EI-247-14
Curved
14 cm (5 1/2")



EI-247-16
Curved
16.5 cm (6 1/2")

Haemostatic Forceps
Arterienklemmen
Pinzas hemostáticas
Pinces hémostatiques
Pinze emostatiche



Kocher (Delicate) Haemostatic Forcep
1 x 2 Teeth



EI-248-13
Straight
13 cm (5")



EI-248-14
Straight
14 cm (5 1/2")



EI-248-17
Straight
16 cm (6 1/4")



EI-249-13
Curved
13 cm (5")



EI-249-14
Curved
14 cm (5 1/2")



EI-249-16
Curved
16 cm (6 1/4")

Haemostatic Forceps
Arterienklemmen
Pinzas hemostáticas
Pincas hémostatiques
Pinze emostatiche



Coller Haemostatic Forcep

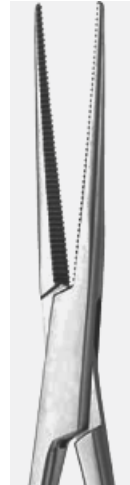

EI-260-14
Straight
14 cm (5 ½")



EI-260-16
Straight
16.5 cm (6 ½")



EI-260-18
Straight
18.5 cm (7 ¼")



EI-261-14
Curved
14 cm (5 ½")



EI-261-16
Curved
16.5 cm (6 ½")

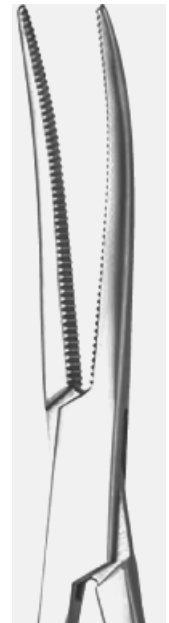

EI-261-18
Curved
18.5 cm (7 ¼")

Haemostatic Forceps
Arterienklemmen
Pinzas hemostáticas
Pinces hémostatiques
Pinze emostatiche



EI-265-18
Fraser-Kelly (Crile) Haemostatic Forcep
Curved
Overall Length 18 cm (7")



EI-268-18
Straight
19 cm (7 1/2")

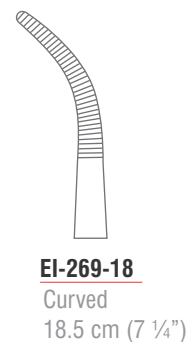

EI-269-18
Curved
18.5 cm (7 1/4")

Adson Haemostatic Forcep

Haemostatic Forceps
Arterienklemmen
Pinzas hemostáticas
Pincès hémostatiques
Pinze emostatiche



EI-271-21
Adson Haemostatic Forcep
Curved
Overall Length 21.5 cm (8 ½")



EI-275-19
Jacobson Haemostatic Forcep
Curved
Overall Length 19 cm (7 ½")

Haemostatic Forceps
Arterienklemmen
Pinzas hemostáticas
Pinces hémostatiques
Pinze emostatiche



EI-2EI-19
Dunhill Haemostatic Forcep
Straight
Overall Length 19 cm (7 ½")

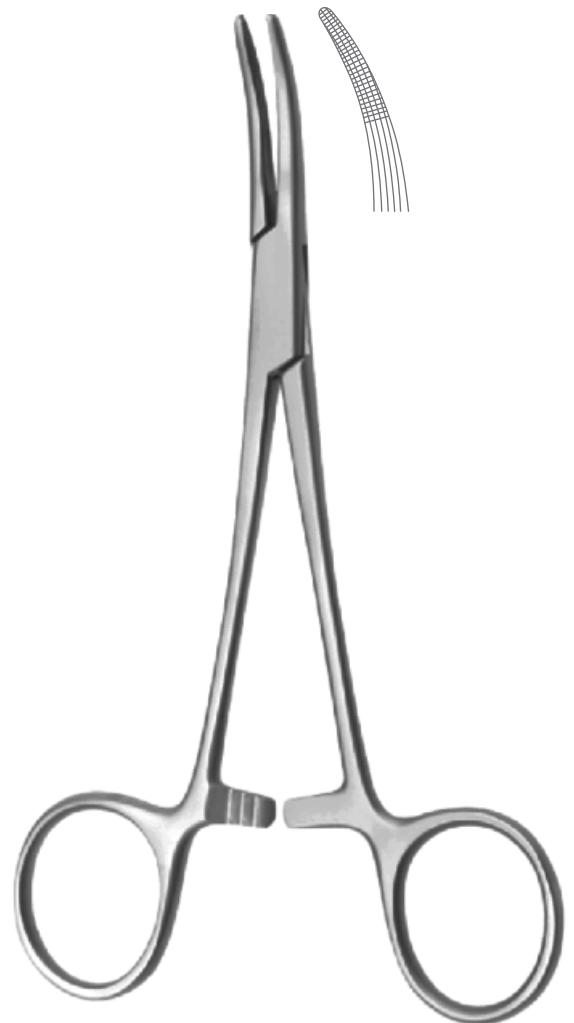

EI-279-19
Grey-Turner Haemostatic Forcep
Curved
Overall Length 18 cm (7")

Haemostatic Forceps
Arterienklemmen
Pinzas hemostáticas
Pincès hémostatiques
Pinze emostatiche

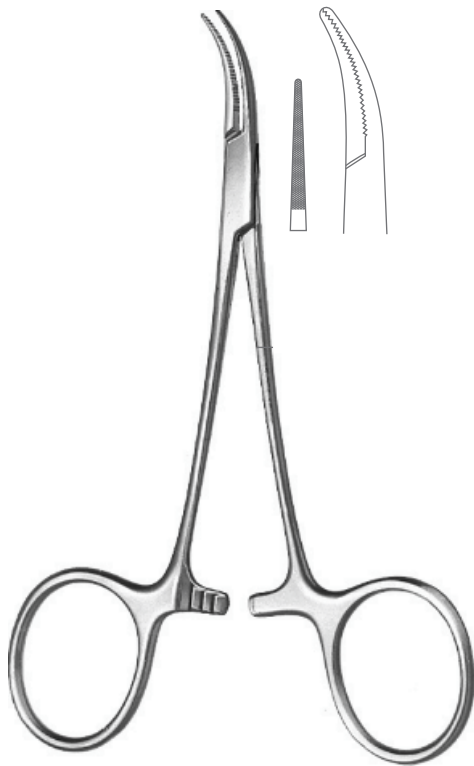

EI-281-12
Dandy-Mosquito Haemostatic Forcep
Laterally Curved, Cross Serrated
Overall Length 12 cm (4 3/4")



EI-283-14
Laterally Curved

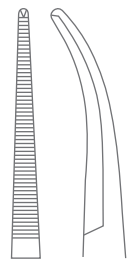

EI-285-14
Laterally Curved
1 x 2 Teeth

Haemostatic Forceps
Arterienklemmen
Pinzas hemostáticas
Pincès hémostatiques
Pinze emostatiche



EI-290-15
Straight



EI-291-15
Curved

Cairns Haemostatic Forcep
Overall Length 15 cm (6")



EI-293-14
Cairns Haemostatic Forcep
Curved to Side
Overall Length 14.5 cm (5 3/4")



EI-295-15
Moynihan Haemostatic Forcep
Curved
Overall Length 15 cm (6")

Haemostatic Forceps
Arterienklemmen
Pinzas hemostáticas
Pincès hémostatiques
Pinze emostatiche

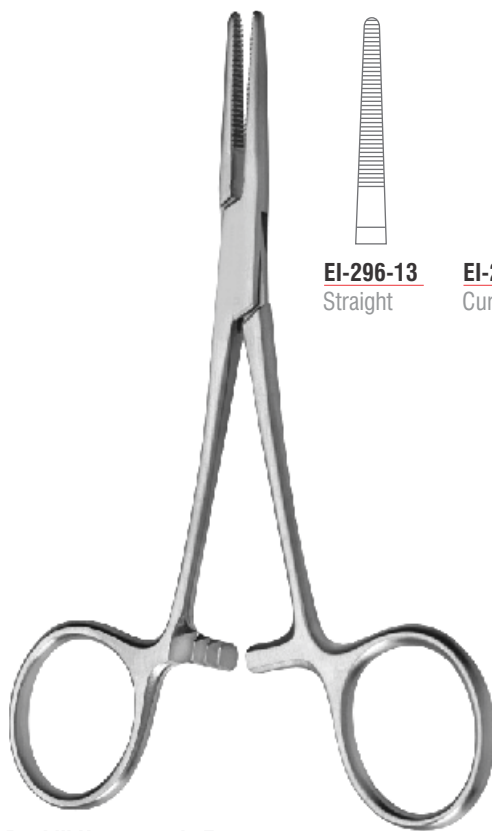

Dunhill Haemostatic Forcep
Overall Length 12.5 cm (5")



EI-296-13
Straight

EI-297-13
Curved



Lovelace Haemostatic Forcep
Straight, Cross Serrated
Overall Length 16 cm (6 1/4")



EI-300-16



EI-302-16
1 x 2 Teeth



Haemostatic Forceps
Arterienklemmen
Pinzas hemostáticas
Pinces hémostatiques
Pinze emostatiche



EI-305-20
Martin-Fuchsig Haemostatic Forcep
Curved
Overall Length 20.5 cm (8")



EI-307-18
18.5 cm (7 1/4")

EI-307-23
23 cm (9")

Nissen Haemostatic Forcep
Curved



EI-311-01
Strongly Curved
18.5 cm (7 1/4")

EI-311-02
Gently Curved
19 cm (7 1/2")

Schnidt Tonsil Haemostatic Forcep

Operating Scissors
Chirurgische Scheren
Tijeras quirúrgicas
Ciseaux chirurgicaux
Forbici per chirurgia

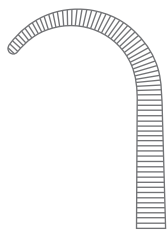

EI-315-01
Fig. 1
19.5 cm (7 ¾")

Negus Haemostatic Forcep



EI-315-02
Fig. 2
20 cm (8")

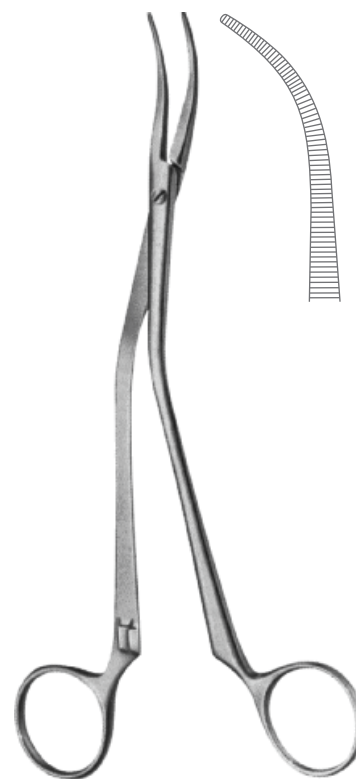

EI-317-19
Wilson Haemostatic Forcep
Curved
Overall Length 19 cm (7 ½")



EI-320-16
17 cm (6 ¾")

Rochester-Carmalt Haemostatic Forcep



EI-320-20
20.5 cm (8")



EI-321-16
16.5 cm (6 ½")



EI-321-20
20 cm (8")

Haemostatic Forceps
Arterienklemmen
Pinzas hemostáticas
Pinces hémostatiques
Pinze emostatiche



EI-331-18



EI-333-18

1 x 2 Teeth

Fickling Haemostatic Forcep

Overall Length 18 cm (7")



EI-340-15

Straight
15 cm (6")



EI-340-18

Straight
18.5 cm (7 1/4")



EI-341-15

Curved
15 cm (6")

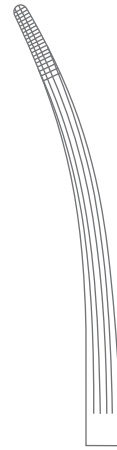

EI-341-18

Curved
18.5 cm (7 1/4")

Bainbridge Haemostatic Forcep

Longitudinally Serrated

Haemostatic Forceps
Arterienklemmen
Pinzas hemostáticas
Pincas hémostatiques
Pinze emostatiche



Collier-Anderson Haemostatic Forcep
Curved

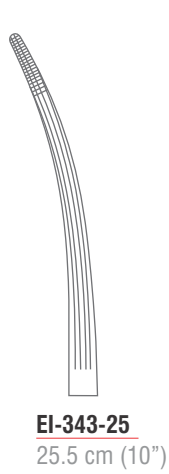

EI-343-25
25.5 cm (10")

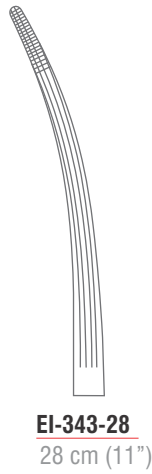

EI-343-28
28 cm (11")



Birkett Haemostatic Forcep
Overall Length 18.5 cm (7 1/4")

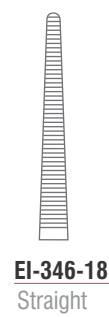

EI-346-18
Straight

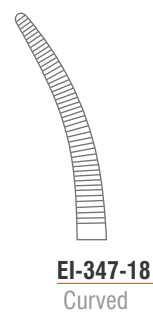

EI-347-18
Curved

Haemostatic Forceps
Arterienklemmen
Pinzas hemostáticas
Pinces hémostatiques
Pinze emostatiche



Bengolea Haemostatic Forcep



EI-350-20
Straight
21.5 cm (8 1/2")



EI-350-26
Straight
26 cm (10 1/4")



EI-351-20
Curved
21 cm (8 1/4")



EI-351-26
Curved
25.5 cm (10 ")



EI-352-20
Straight
1 x 2 Teeth
21.5 cm (8 1/2")



EI-352-26
Straight
1 x 2 Teeth
26 cm (10 1/4")

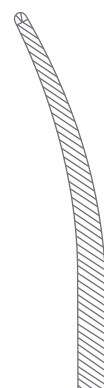

EI-353-20
Curved
1 x 2 Teeth
21 cm (8 1/4")

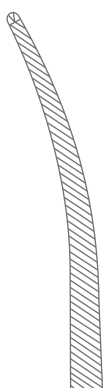

EI-353-26
Curved
1 x 2 Teeth
25.5 cm (10 ")

Operating Scissors
Chirurgische Scheren
Tijeras quirúrgicas
Ciseaux chirurgicaux
Forbici per chirurgia



Roberts Haemostatic Forcep



EI-360-22
Straight
22.5 cm (8 ¾")

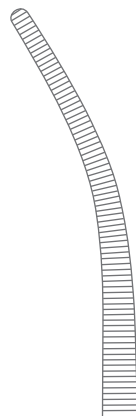

EI-361-22
Curved
21.5 cm (8 ½")



Sarot Haemostatic Forcep



EI-364-24
Straight
25 cm (9 ¾")

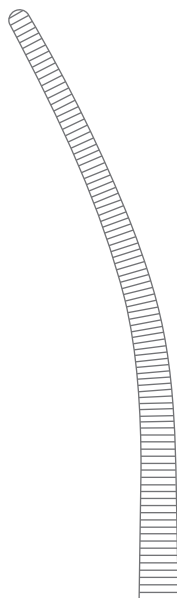

EI-365-24
Curved
24.5 cm (9 ¾")

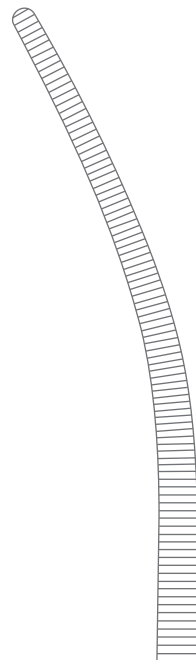

EI-365-28
Curved
28 cm (11")

Haemostatic Forceps
Arterienklemmen
Pinzas hemostáticas
Pinces hémostatiques
Pinze emostatiche



EI-371-18
18 cm (7")

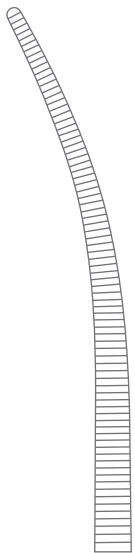

EI-371-24
24.5 cm (9 3/4")

Crafoord Haemostatic Forcep
Curved



EI-375-01
Fig. 1

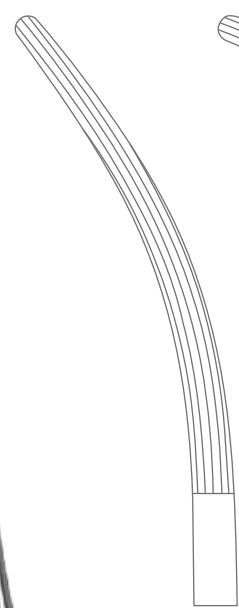

EI-375-02
Fig. 2

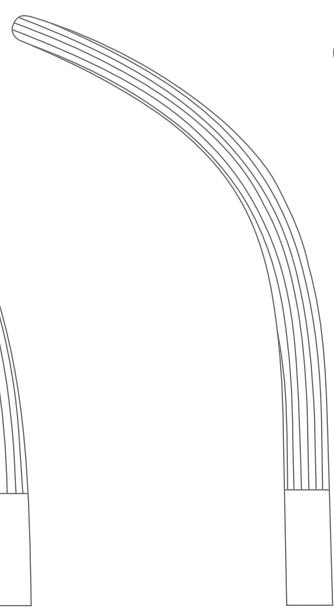

EI-375-03
Fig. 3



Crafoord-Sellors Haemostatic Forcep
Overall Length 24 cm (9 1/2")

Haemostatic Forceps
Arterienklemmen
Pinzas hemostáticas
Pinces hémostatiques
Pinze emostatiche



Bridge Haemostatic Forcep
Overall Length 27.5 cm (10 ¾")



EI-380-27
Straight



EI-381-27
Curved



Heiss Haemostatic Forcep



EI-386-20
21 cm (8 ¼")

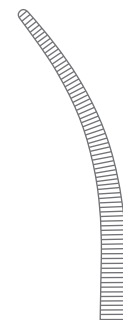

EI-3EI-20
20.5 cm (8")

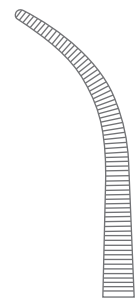

EI-389-20
20 cm (8")

Haemostatic Forceps, Dissecting and Ligature Forceps
 Arterienklemmen, Präparierklemmen
 Pinzas hemostáticas, Pinzas para preparación y ligadura
 Pinces hémostatiques, Pinces à disséquer et à ligatures
 Pinze emostatiche, Pinze per preparazioni e legature



EI-390-20
 Straight
 1 x 2 Teeth

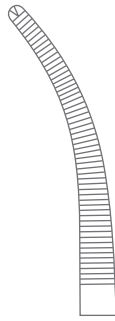

EI-391-20
 Curved
 1 x 2 Teeth

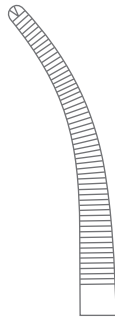

Heiss Haemostatic Forcep
 Overall Length 20 cm (8")



Overholt-Martin Dissecting and Ligature Forcep

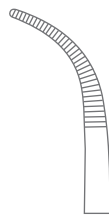

EI-401-01
 Fig. 1
 18.5 cm (7 1/4")

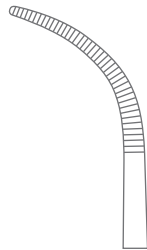

EI-401-02
 Fig. 2
 20.5 cm (8")

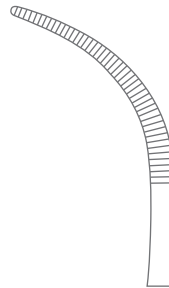

EI-401-03
 Fig. 3
 21 cm (8 1/4")



EI-401-04
 Fig. 4
 21.5 cm (8 1/2")

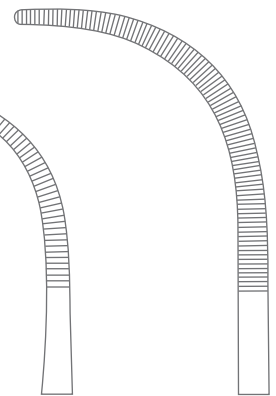

EI-401-05
 Fig. 5
 24.5 cm (9 3/4")



Dissecting and Ligature Forceps
Präparierklemmen
Pinzas para preparación y ligadura
Pinces à disséquer et à ligatures
Pinze per preparazioni e legature



EI-404-12
Dissecting and Ligature Forcep
Smooth Jaws
Overall Length 12.5 cm (5")



EI-405-14
Guys Galabin Suture Forcep
Angled to Side, Smooth Jaws
Overall Length 14 cm (5 ½")



EI-407-14
Parotid Spreading Forcep
Fine Curved
Overall Length 14 cm (5 ½")

Dissecting and Ligature Forceps
Präparierklemmen
Pinzas para preparación y ligadura
Pincès à disséquer et à ligatures
Pinze per preparazioni e legature



Adson-Baby Dissecting and Ligature Forcep
Curved

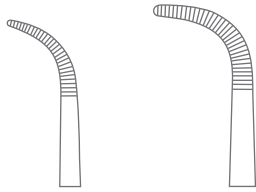

EI-411-14
14.5 cm (5 3/4")

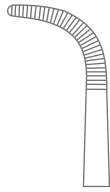

EI-411-18
18 cm (7")



EI-415-14
Overholt-Baby Dissecting and Ligature Forcep
Curved
Overall Length 14 cm (5 1/2")

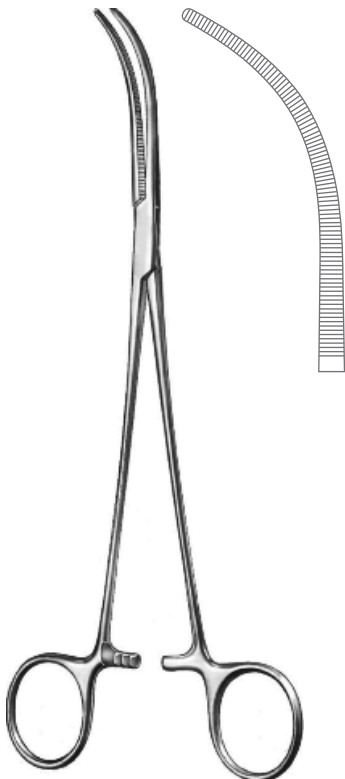

EI-417-21
Overholt-Mixter Dissecting and Ligature Forcep
Curved
Overall Length 21.5 cm (8 1/2")

Dissecting and Ligature Forceps
 Präparierklemmen
 Pinzas para preparación y ligadura
 Pincès à disséquer et à ligatures
 Pinze per preparazioni e legature

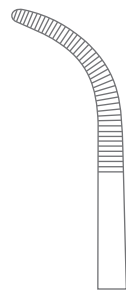

EI-421-01
 Fig. 1
 20.5 cm (8")

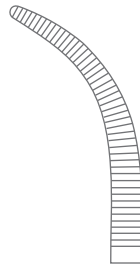

EI-421-02
 Fig. 2
 20 cm (8")

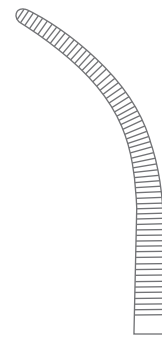

EI-421-03
 Fig. 3
 21.5 cm (8 1/2")

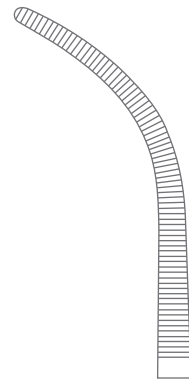

EI-421-04
 Fig. 4
 22 cm (8 3/4")

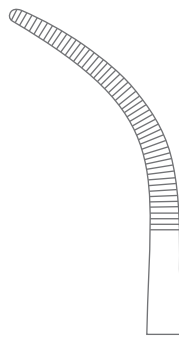

EI-421-05
 Fig. 5
 21.5 cm (8 1/2")

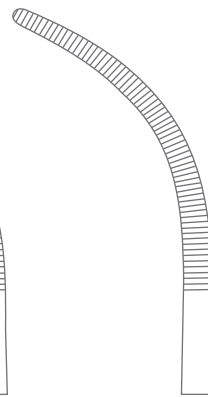

EI-421-06
 Fig. 6
 22 cm (8 3/4")



EI-421-07
 Fig. 7
 22 cm (8 3/4")

Overholt-Geissendoerfer Dissecting and Ligature Forcep

Dissecting and Ligature Forceps
 Präparierklemmen
 Pinzas para preparación y ligadura
 Pinces à disséquer et à ligatures
 Pinze per preparazioni e legature

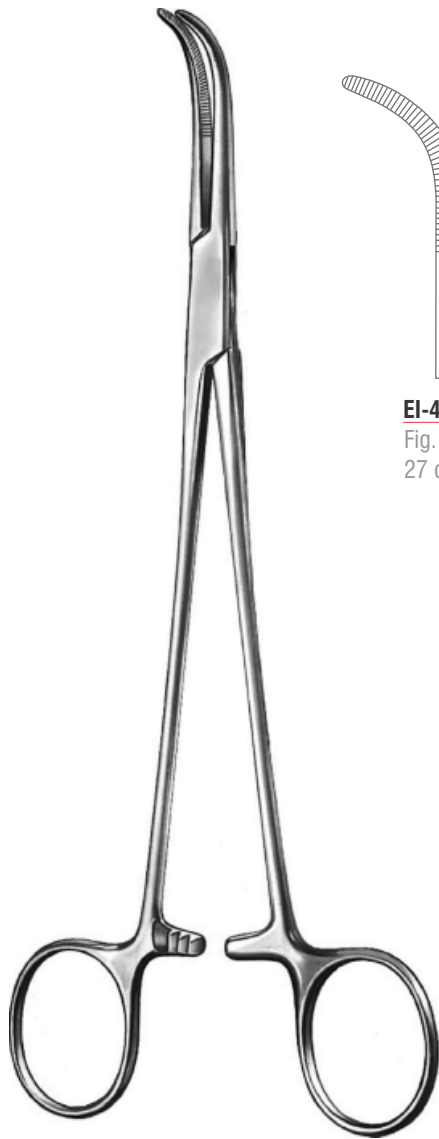

Overholt-Geissendoerfer Dissecting and Ligature Forcep

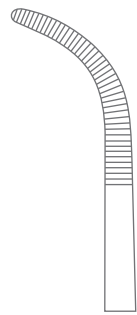

EI-4EI-01

Fig. 1
27 cm (10 3/4")

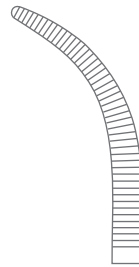

EI-4EI-02

Fig. 2
26.5 cm (10 1/2")

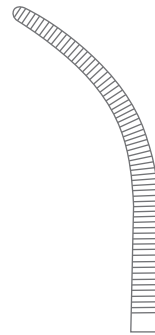

EI-4EI-03

Fig. 3
27.5 cm (10 3/4")

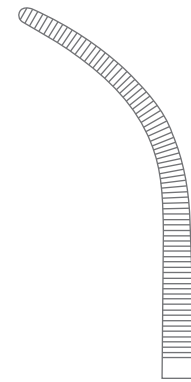

EI-4EI-04

Fig. 4
28 cm (11")

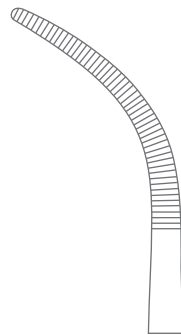

EI-4EI-05

Fig. 5
27.5 cm (10 3/4")

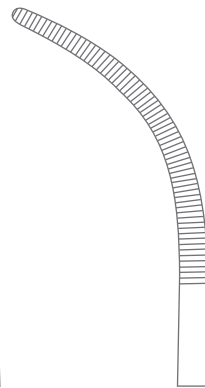

EI-4EI-06

Fig. 6
28 cm (11")



EI-4EI-07

Fig. 7
27.5 cm (10 3/4")



Dissecting and Ligature Forceps
Präparierklemmen
Pinzas para preparación y ligadura
Pinces à disséquer et à ligatures
Pinze per preparazioni e legature

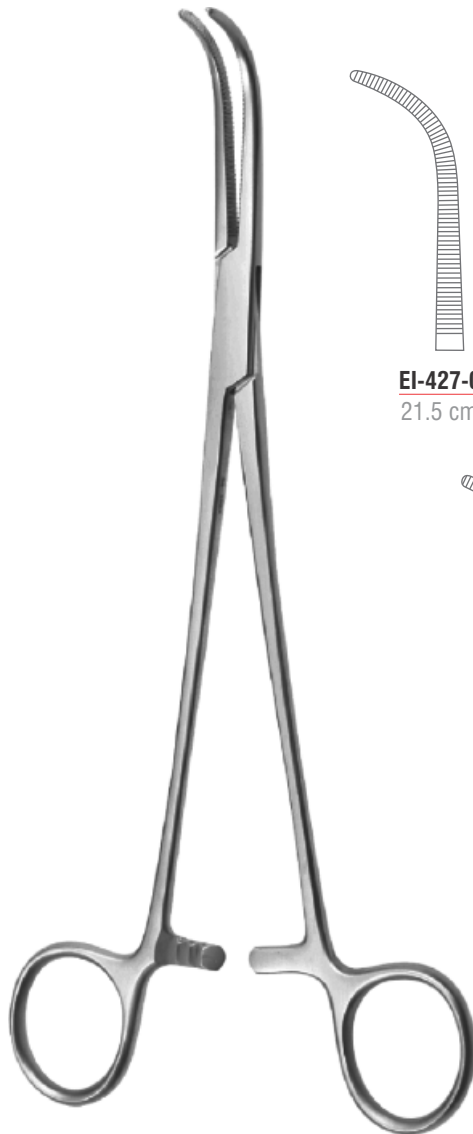

Overholt-Fine Dissecting and Ligature Forcep
Curved

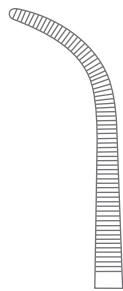

EI-427-00
21.5 cm (8 1/2")

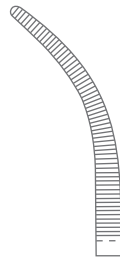

EI-427-01
21 cm (8 1/4")

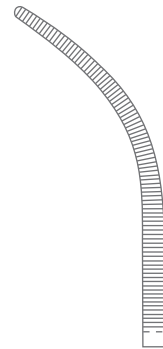

EI-427-02
22 cm (8 3/4")



EI-427-03
23 cm (9")



EI-427-06
22.5 cm (8 3/4")

Dissecting and Ligature Forceps
Präparierklemmen
Pinzas para preparación y ligadura
Pincès à disséquer et à ligatures
Pinze per preparazioni e legature



EI-429-00
29 cm (11 1/2")

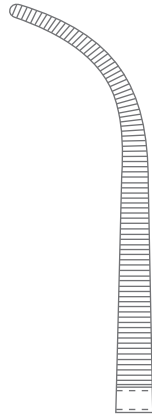

EI-429-01
29 cm (11 1/2")

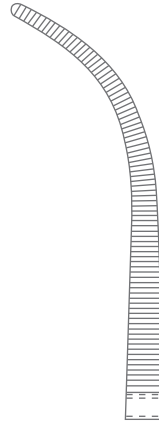

EI-429-02
30 cm (11 3/4")

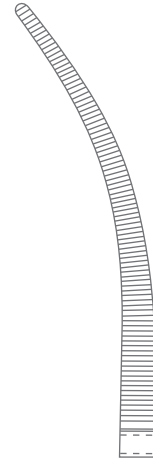

Overholt Dissecting and Ligature Forcep
Curved

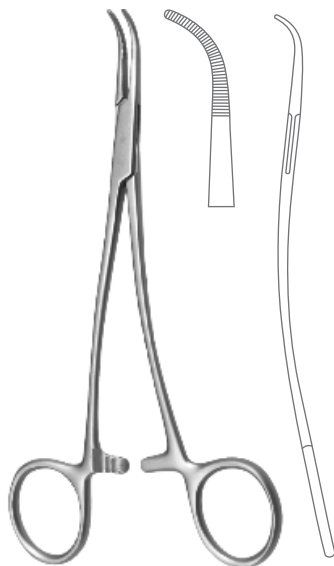

EI-431-15
Overholt-Mini Dissecting and Ligature Forcep
Curved, S Shaped
Overall Length 15 cm (6")



EI-433-20
Overholt-Mini Dissecting and Ligature Forcep
Curved
Overall Length 20 cm (8")

Dissecting and Ligature Forceps
 Präparierklemmen
 Pinzas para preparación y ligadura
 Pincès à disséquer et à ligatures
 Pinze per preparazioni e legature



Kelly Dissecting and Ligature Forcep

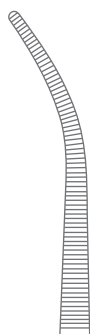

EI-441-19
 Fig. 1
 19.5 cm (7 3/4")



EI-441-22
 Fig. 1
 22.5 cm (8 3/4")



EI-441-24
 Fig. 1
 24.5 cm (9 3/4")



EI-443-19
 Fig. 2
 19 cm (7 1/2")



EI-443-22
 Fig. 2
 22 cm (8 3/4")



EI-443-24
 Fig. 2
 24 cm (9 1/2")



EI-445-19
 Fig. 3
 18.5 cm (7 1/4")



EI-445-22
 Fig. 3
 21.5 cm (8 1/2")



EI-445-24
 Fig. 3
 23.5 cm (9 1/4")

Dissecting and Ligature Forceps
Präparierklemmen
Pinzas para preparación y ligadura
Pinces à disséquer et à ligatures
Pinze per preparazioni e legature



EI-451-28
Lawrence Dissecting and Ligature Forcep
Curved
Overall Length 28 cm (11")



EI-455-28
Meeker Dissecting and Ligature Forcep
Right Angled
Overall Length 28 cm (11")



Mini-Gemini Dissecting and Ligature Forcep
Curved

EI-469-18
18 cm (7")

EI-469-22
22.5 cm (8 3/4")

EI-469-25
25 cm (9 3/4")

EI-469-28
28.5 cm (11 1/4")

Dissecting and Ligature Forceps
 Präparierklemmen
 Pinzas para preparación y ligadura
 Pincès à disséquer et à ligatures
 Pinze per preparazioni e legature

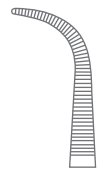
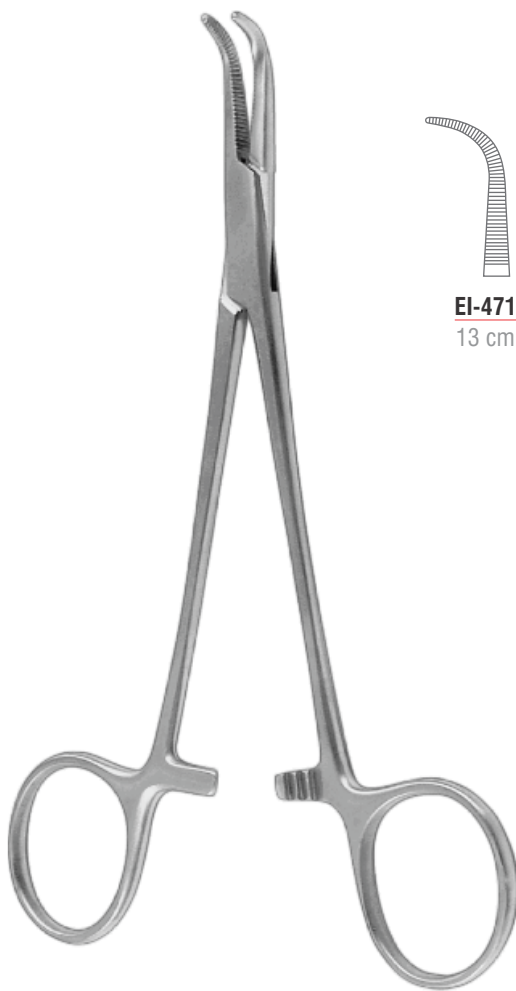

EI-471-13
13 cm (5")

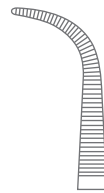

EI-471-16
16 cm (6 ¼")

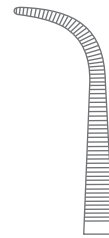

EI-471-18
18 cm (7")

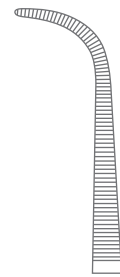

EI-471-20
21 cm (8 ¼")

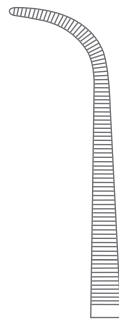

EI-471-23
23 cm (9")

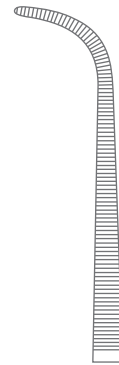

EI-471-25
25 cm (9 ¾")

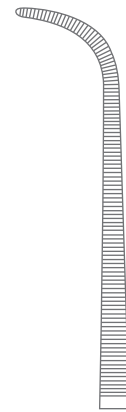

EI-471-28
28 cm (11")

Gemini Dissecting and Ligature Forcep
Curved

Dissecting and Ligature Forceps
 Präparierklemmen
 Pinzas para preparación y ligadura
 Pinces à disséquer et à ligatures
 Pinze per preparazioni e legature



Rumel Dissecting and Ligature Forcep
 Curved

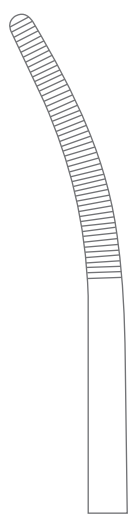

EI-475-01
 24 cm (9 1/2")

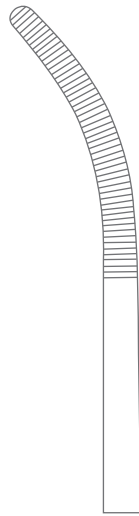

EI-475-02
 23.5 cm (9 1/2")

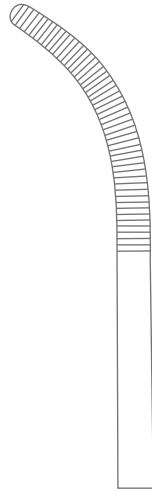

EI-475-03
 23 cm (9")

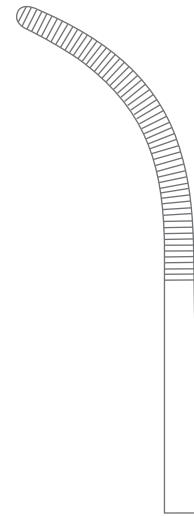

EI-475-04
 24 cm (9 1/2")

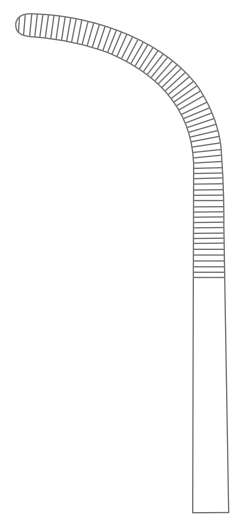

EI-475-05
 23.5 cm (9 1/4")



Dissecting and Ligature Forceps
 Präparierklemmen
 Pinzas para preparación y ligadura
 Pincès à disséquer et à ligatures
 Pinze per preparazioni e legature



EI-479-01
29.5 cm (11 1/2")

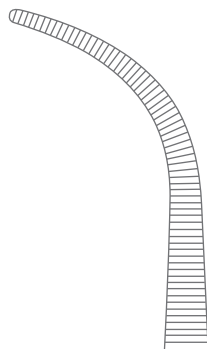
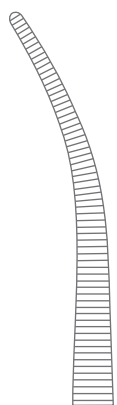

EI-479-02
28.5 cm (11 1/4")

Zenker Dissecting and Ligature Forcep
Curved



EI-481-23
Kieback Dissecting and Ligature Forcep
Curved
Overall Length 23.5 cm (9 1/4")

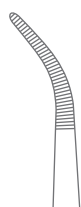
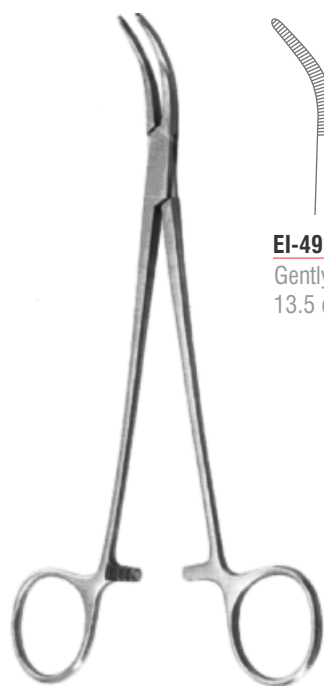

EI-491-01
Gently Curved
13.5 cm (5 1/4")

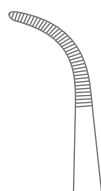

EI-491-02
Strongly Curved
13 cm (5")

Mixter-Baby Dissecting and Ligature Forcep

Dissecting and Ligature Forceps
 Präparierklemmen
 Pinzas para preparación y ligadura
 Pinces à disséquer et à ligatures
 Pinze per preparazioni e legature



EI-493-14
Mixer-Baby Dissecting and Ligature Forcep
 Curved
 Overall Length 13.5 cm (5 1/4")



EI-495-18
Mixer-Baby Dissecting and Ligature Forcep
 Curved
 Overall Length 18.5 cm (7 1/4")



Mixer Dissecting and Ligature Forcep
 Right Angled

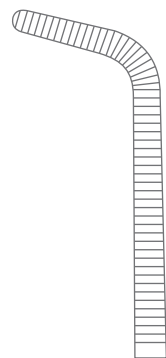

EI-497-15
 16 cm (6 1/4")

EI-497-19
 18 cm (7")



Mixer Dissecting and Ligature Forcep
 Curved

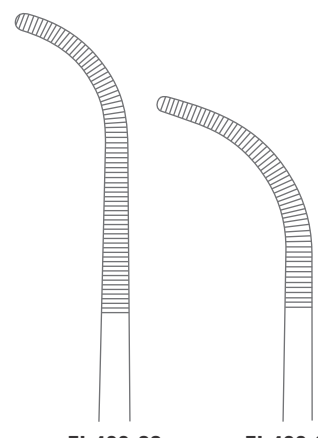

EI-499-22
 22.5 cm (8 3/4")

EI-499-23
 23 cm (9")

Dissecting and Ligature Forceps
 Präparierklemmen
 Pinzas para preparación y ligadura
 Pincès à disséquer et à ligatures
 Pinze per preparazioni e legature



EI-501-22
22.5 cm (8 ¾")

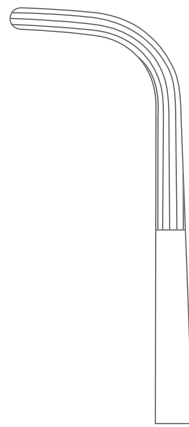

EI-501-25
26 cm (10 ¼")

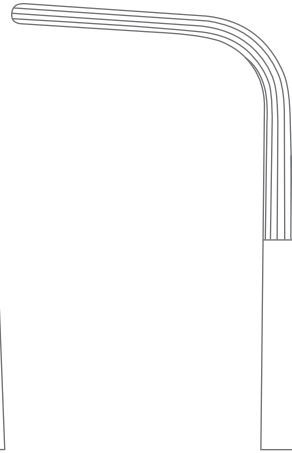

EI-501-28
28 cm (11")

Mixer Dissecting and Ligature Forcep
 Right Angled, Longitudinally Serrated



EI-505-22
Mc Quigg-Mixer Dissecting and Ligature Forcep
 Right Angled, Longitudinally Serrated
 Overall Length 23.5 cm (9 ¼")



EI-509-19
Mixer-O'Shaughnessy Dissecting and Ligature Forcep
 Curved
 Overall Length 18.5 cm (7")

Dissecting and Ligature Forceps
 Präparierklemmen
 Pinzas para preparación y ligadura
 Pinces à disséquer et à ligatures
 Pinze per preparazioni e legature



O'Shaughnessy Dissecting and Ligature Forcep
 Curved

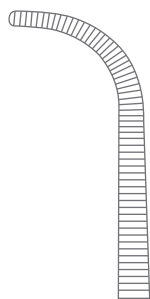

EI-511-14
 15 cm (6")

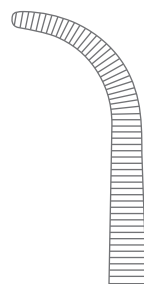

EI-511-17
 18 cm (7")



EI-511-20
 20 cm (8")

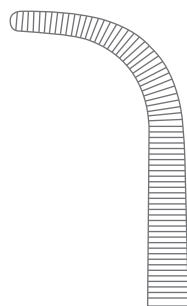

EI-511-23
 23 cm (9")

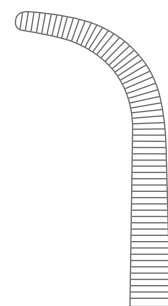

EI-511-26
 26 cm (10 ¼")

Dissecting and Ligature Forceps
Präparierklemmen
Pinzas para preparación y ligadura
Pinces à disséquer et à ligatures
Pinze per preparazioni e legature



Wickstroem Dissecting and Ligature Forcep
Right Angled

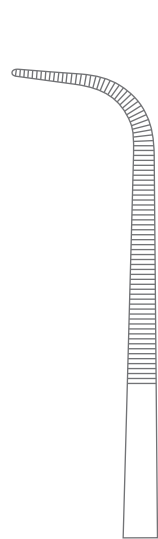

EI-517-21
21 cm (8 1/4")



EI-517-24
24.5 cm (9 3/4")



EI-519-18
Lahey Dissecting and Ligature Forcep
Curved
Overall Length 18.5 cm (7 1/4")

Dissecting and Ligature Forceps
 Präparierklemmen
 Pinzas para preparación y ligadura
 Pincès à disséquer et à ligatures
 Pinze per preparazioni e legature



EI-5EI-20
20 cm (8")

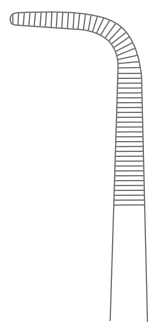

EI-5EI-25
25 cm (9 3/4")

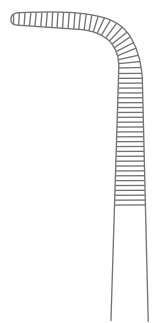

EI-5EI-27
27.5 cm (10 3/4")

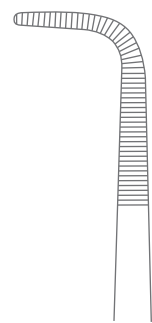

Kantrowitz Dissecting and Ligature Forcep
Right Angled

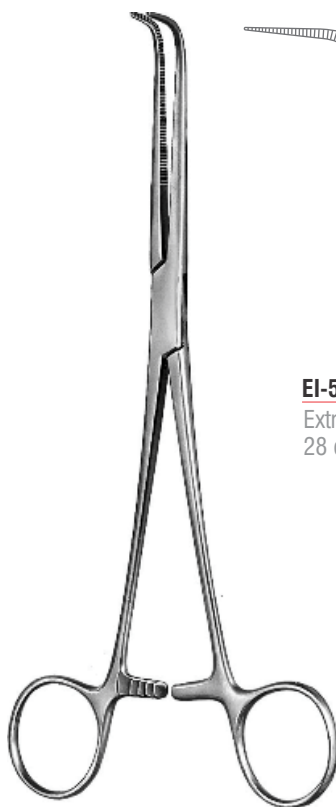

EI-527-28
Extra Delicate
28 cm (11")

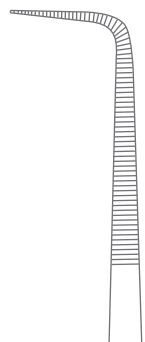

EI-529-28
Delicate
28 cm (11")

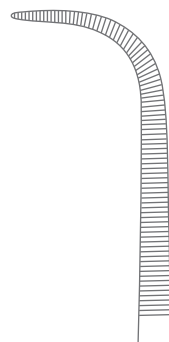

Barre Dissecting and Ligature Forcep

Dissecting and Ligature Forceps
 Präparierklemmen
 Pinzas para preparación y ligadura
 Pincès à disséquer et à ligatures
 Pinze per preparazioni e legature

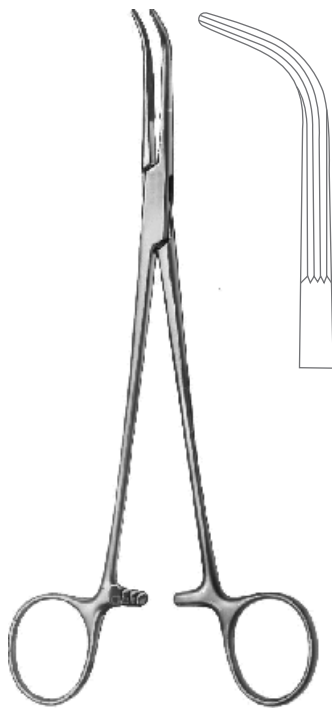

EI-535-19
Lahey (Sweet) Bile Duct Clamp
 Curved
 Overall Length 19.5 cm (7 ¾")



EI-5EI-23
Lahey Bile Duct Clamp
 Angled
 Overall Length 22.5 cm (8 ¾")



EI-539-23
Lahey Bile Duct Clamp
 Curved
 Overall Length 23 cm (9")

Dissecting and Ligature Forceps, Tangential Forceps
 Präparierklemmen, Tangentialklemmen
 Pinzas para preparación y ligadura, Pinzas tangenciales
 Pinces à disséquer et à ligatures, Pinces tangentielles
 Pinze per preparazioni e legature, Pinze tangenziali



EI-541-24
Finochietto Dissecting and Ligature Forcep
 Right Angled
 Overall Length 24 cm (9 1/2")



URO-Tangential Atrauma Occlusion Clamp

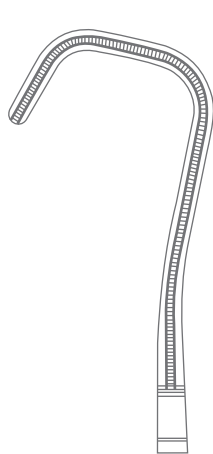

EI-551-01
 Fig. 1
 25 cm (9 3/4")

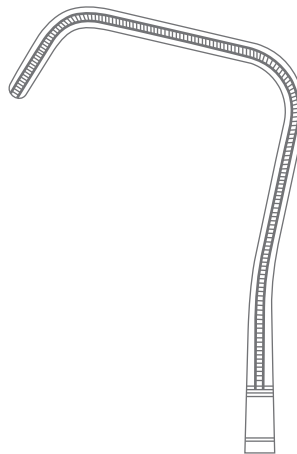

EI-551-02
 Fig. 2
 27 cm (10 3/4")



Kidney Pedicle Clamps
Nierenstielklemmen
Pinzas para pedículo renal
Pince-clamps pour pédicules rénaux
Pinze per peduncoli renali



Guyon Atrauma Kidney Pedicle Clamp
Curved

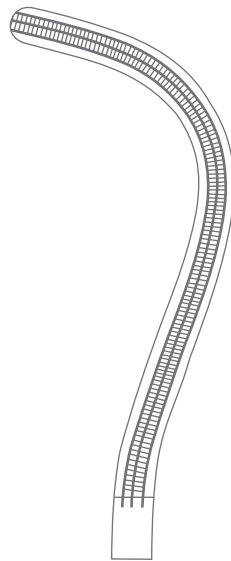

EI-561-23
23 cm (9")

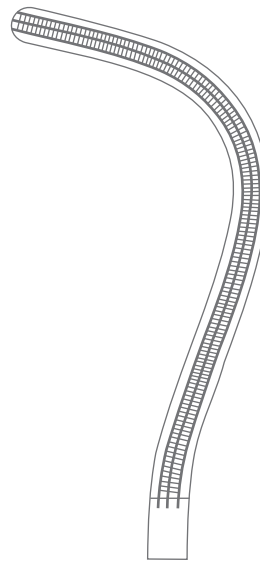

EI-561-24
24 cm (9 1/2")

Kidney Pedicle Clamps
Nierenstielklemmen
Pinzas para pedículo renal
Pince-clamps pour pédicules rénaux
Pinze per peduncoli renali

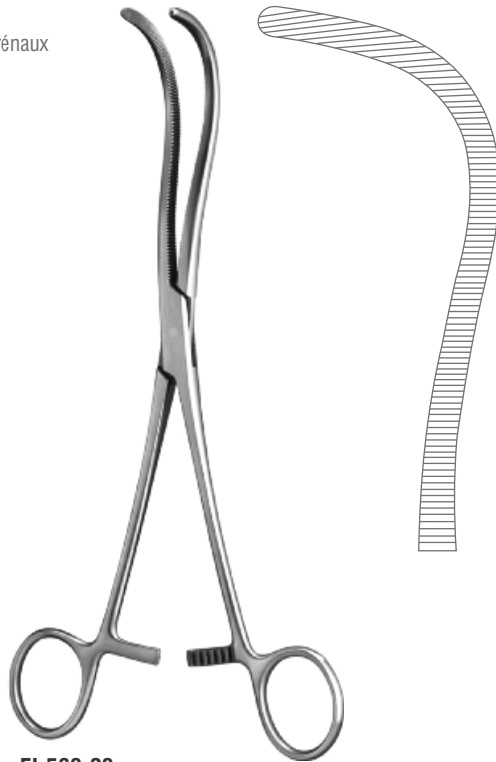

EI-563-23
Guyon Kidney Pedicle Clamp
Curved
Overall Length 24 cm (9 1/2")



Guyon Kidney Pedicle Clamp
Curved

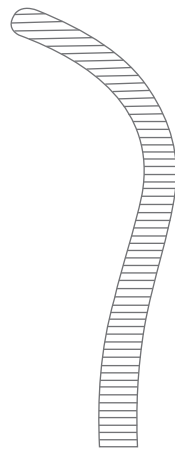

EI-565-20
19.5 cm (7 3/4")

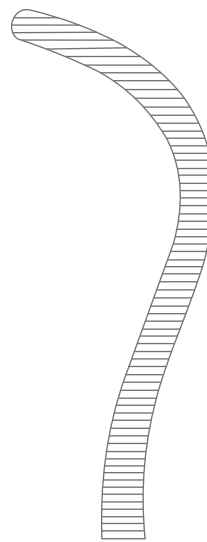

EI-565-22
21.5 cm (8 1/2")

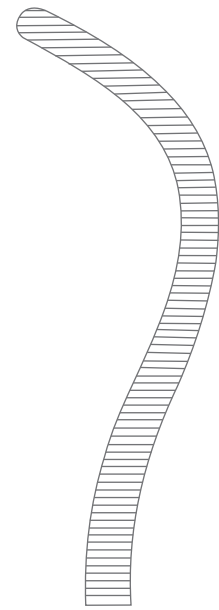

EI-565-24
24 cm (9 1/2")



Kidney Pedicle Clamps
Nierenstielklemmen
Pinzas para pedículo renal
Pince-clamps pour pédicules rénaux
Pinze per peduncoli renali

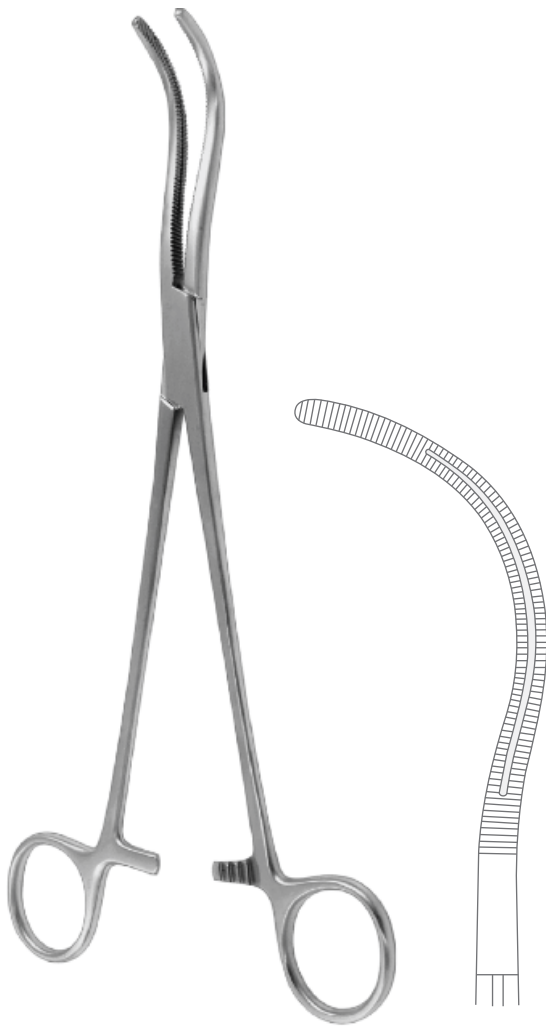

EI-569-23
Stille Kidney Pedicle Clamp
Curved, Grooved
Overall Length 23 cm (9")



EI-571-23
Herrick Kidney Pedicle Clamp
Double Angled, Longitudinally Serrated
Overall Length 23 cm (9")

Bile Duct Clamps, Dissecting and Ligature Forceps
 Gallenkanalklemmen, Präparierklemmen
 Pinzas para conducto biliar, Pinzas para preparación y ligadura
 Pincers pour les voies biliaires, Pincers à disséquer et à ligatures
 Pinze per vie biliari, Pinze per preparazioni e legature



EI-581-21
Desjardins Bile Duct Clamp
 Curved Downwards
 Overall Length 21 cm (8 1/4")



EI-583-21
Nissen Bile Duct Clamp
 Curved Downwards
 Overall Length 21.5 cm (8 1/2")



Gray Dissecting and Ligature Forcep
 Curved S Shaped

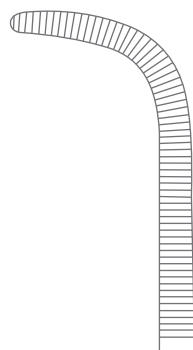

EI-591-01
 22 cm (8 3/4")

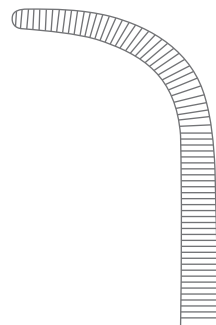

EI-591-02
 22 cm (8 3/4")

Hysterectomy Forceps
 Hysterektomieklappen
 Pinzas para histerectomia
 Pinces à hystérectomie
 Pinze per isterectomia

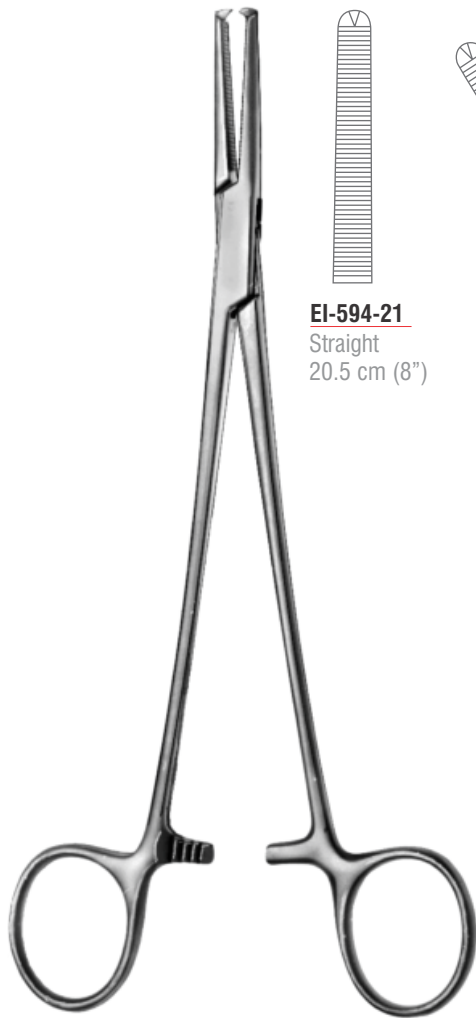

EI-594-21
 Straight
 20.5 cm (8")

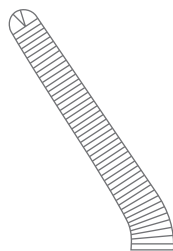

EI-595-21
 Curved
 20 cm (8")

Phaneuf Hysterectomy Forceps
 1 x 2 Teeth



EI-597-20
 Curved
 20.5 cm (8")

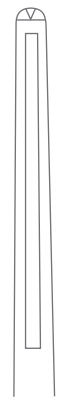

EI-598-20
 Straight
 20 cm (8")

Maingot Hysterectomy Forceps
 1 x 2 Teeth



Hysterectomy Forceps
Hysterektomieklemmen
Pinzas para histerectomía
Pinces à hystérectomie
Pinze per isterectomia



Heaney-Ballentine Hysterectomy Forcep
Overall Length 21.5 cm (8 ½")



EI-600-21
Straight



EI-601-21
Straight



EI-604-21
Heaney-Razek Hysterectomy Forcep
Straight
Overall Length 21 cm (8 ¼")

Hysterectomy Forceps
 Hysterektomieklennen
 Pinzas para histerectomia
 Pincés à hystérectomie
 Pinze per isterectomia



Heaney Hysterectomy Forcep

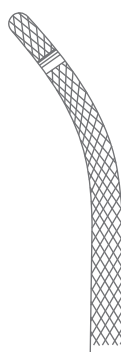

EI-607-19
 Curved, 1 Tooth
 19.5 cm (7 ¾")

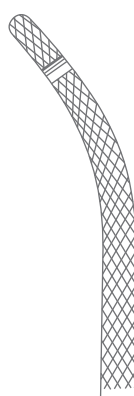

EI-607-21
 Curved, 1 Tooth
 21.5 cm (8 ½")

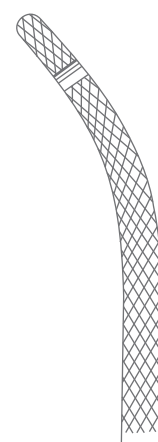

EI-607-23
 Curved, 1 Tooth
 24 cm (9 ½")

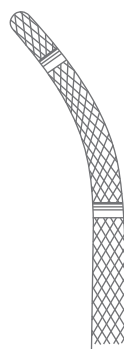

EI-609-19
 Curved, 2 Tooth
 19.5 cm (7 ¾")



EI-609-21
 Curved, 2 Tooth
 21.5 cm (8 ½")



EI-609-23
 Curved, 2 Tooth
 24 cm (9 ½")

Hysterectomy Forceps
Hysterektomieklemmen
Pinzas para histerectomía
Pinces à hystérectomie
Pinze per isterectomia



EI-617-25
Parker-Kerr Anastomosis Clamp
Curved With Longitudinally Serrated Jaws
Overall Length 25 cm (10")



Dick Atrauma Vaginal Clamp
Angled

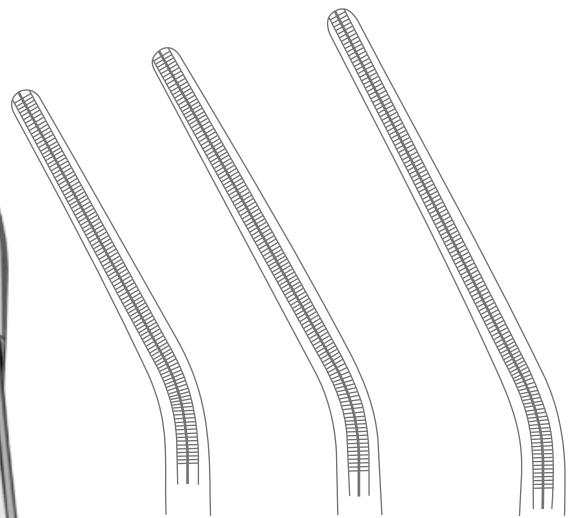

EI-621-25
25.5 cm (10")

EI-621-25
26.5 cm (10 1/2")

EI-621-25
27.5 cm (10 3/4")

Hysterectomy Forceps
Hysterektomieklennen
Pinzas para histerectomia
Pinces à hystérectomie
Pinze per isterectomia



EI-625-25
Wertheim Atrauma Vaginal Clamp
Right Angled
Overall Length 25 cm (9 3/4")



EI-629-21
Wertheim-Cullen Vaginal Clamp
Overall Length 21 cm (8 1/4")

Hysterectomy Forceps
Hysterektomieklemmen
Pinzas para histerectomía
Pincas à hysterectomie
Pinze per isterectomia



Zeppelin Hysterectomy Clamp



EI-6EI-01
Zeppelin Hysterectomy Clamp
Curved, S Shaped
Overall Length 24 cm (8 ½")



EI-630-21
Straight
21.5 cm (8 ½")

EI-630-24
Straight
24 cm (9 ½")

EI-630-30
Straight
30 cm (12")



EI-631-21
Slightly Curved
21.5 cm (8 ½")

EI-631-24
Slightly Curved
24 cm (9 ½")

EI-631-30
Slightly Curved
30 cm (12")



EI-632-21
Medium Curved
21.5 cm (8 ½")

EI-632-24
Medium Curved
24 cm (9 ½")

EI-632-30
Medium Curved
30 cm (12")

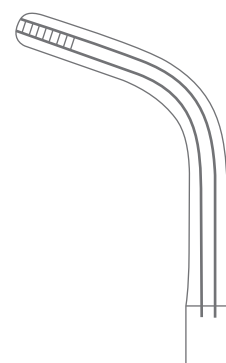

EI-633-21
Strongly Curved
21.5 cm (8 ½")

EI-633-24
Strongly Curved
24 cm (9 ½")

EI-633-30
Strongly Curved
30 cm (12")

Hysterectomy Forceps
Hysterektomieklappen
Pinzas para histerectomía
Pincers à hystérectomie
Pinze per isterectomia



EI-635-10

Fig. 1
21.5 cm (8 ½")

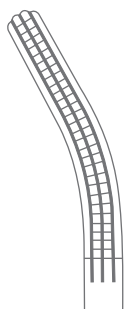
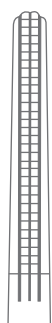

EI-635-20

Fig. 2
21 cm (8 ¼")

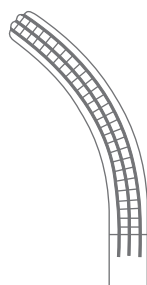

EI-635-30

Fig. 3
20.5 cm (8")

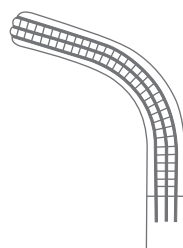

EI-635-40

Fig. 4
20 cm (8")

Heaney (Rogers) Hysterectomy Forcep



EI-6EI-10

Fig. 1
25.5 cm (10")

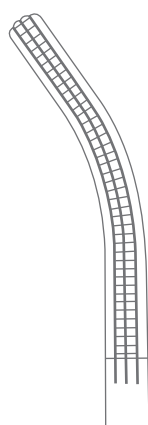

EI-6EI-20

Fig. 2
25 cm (9 ¾")

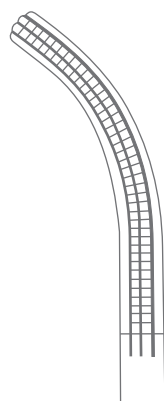

EI-6EI-30

Fig. 3
24.5 cm (9 ¾")



EI-639-22

Wertheim Hysterectomy Forcep
Angled
Overall Length 22 cm (8 ¾")

Wertheim (Rogers) Hysterectomy Forcep

Hysterectomy Forceps
Hysterektomieklemmen
Pinzas para histerectomía
Pinces à hystérectomie
Pinze per isterectomia



Second-Landau Hysterectomy Forcep
Overall Length 24 cm (9 1/2")

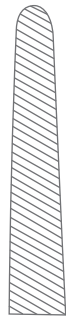

EI-642-24
Straight

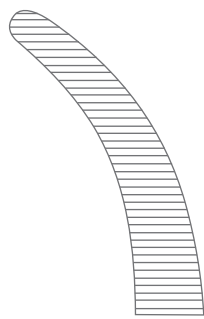

EI-643-24
Curved



Holzbach Hysterectomy Forcep
Overall Length 24.5 cm (9 3/4")



EI-646-24
Straight
1 x 2 Teeth

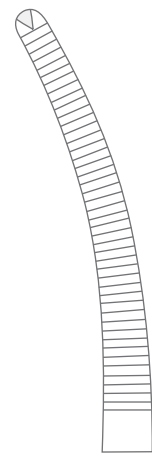

EI-647-24
Curved
1 x 2 Teeth



Hysterectomy Forceps
Hysterektomieklennen
Pinzas para histerectomia
Pinces à hystérectomie
Pinze per isterectomia



EI-648-20
Straight



EI-649-20
Curved

Gwilliam Hysterectomy Forcep
Overall Length 20 cm (8")

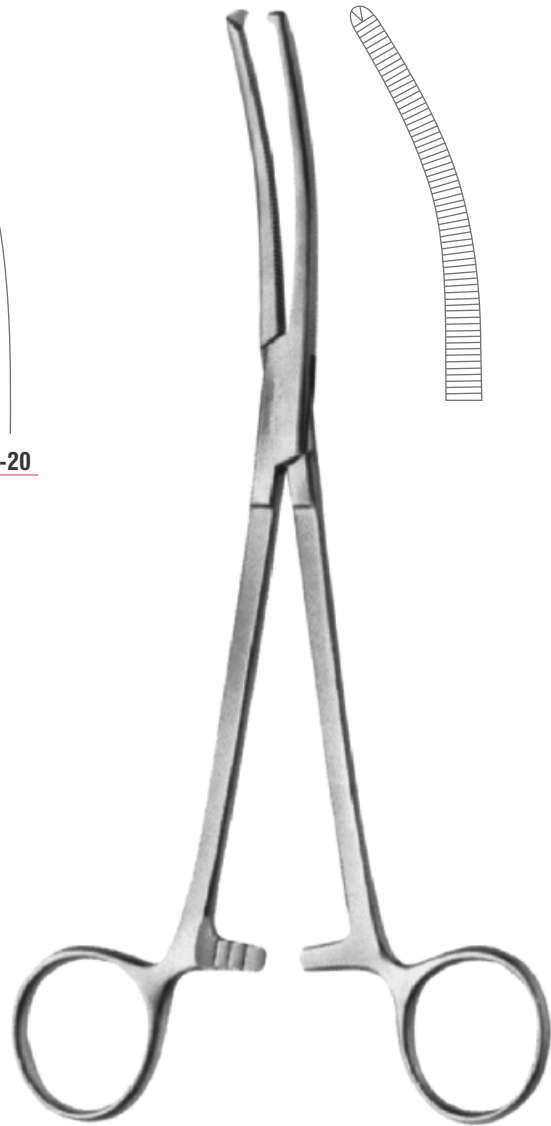

EI-651-20
Berkeley-Bonney Hysterectomy Forcep
Curved
Overall Length 20 cm (8")



Hysterectomy Forceps
Hysterektomieklemmen
Pinzas para histerectomía
Pinces à hystérectomie
Pinze per isterectomia



Kieback Hysterectomy Forcep
Overall Length 25 cm (9 3/4")

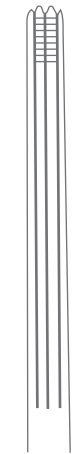

EI-654-25
Straight



EI-655-25
Curved



Burke Hysterectomy Forcep
Overall Length 25 cm (9 3/4")

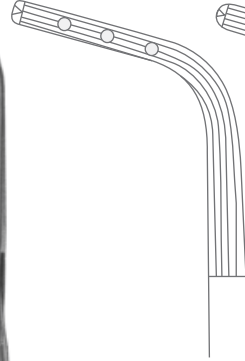

EI-657-25
Curved
Short Jaws
1 x 2 Teeth

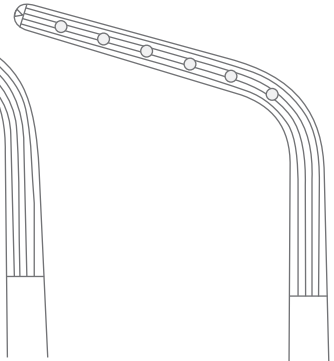

EI-659-25
Curved
Long Jaws
1 x 2 Teeth



Hysterectomy Forceps
Hysterektomieklemmen
Pinzas para histerectomía
Pinces à hystérectomie
Pinze per isterectomia



EI-661-23
Moynihan Hysterectomy Forcep
Curved
Overall Length 23 cm (9")

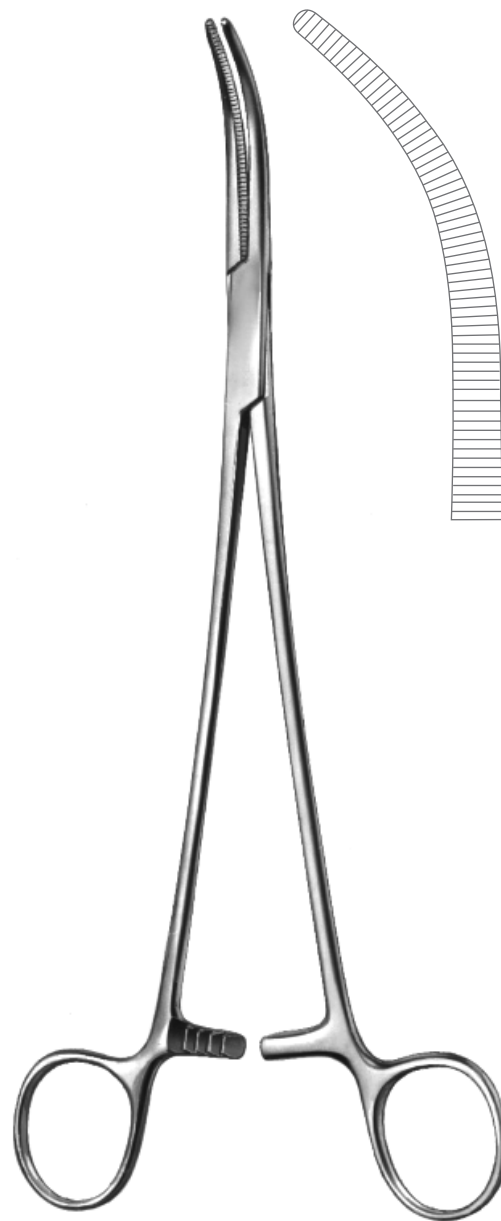

EI-663-24
Moynihan Hysterectomy Forcep
Curved
Overall Length 23.5 cm (9 1/4")

Hysterectomy Forceps
Hysterektomieklemmen
Pinzas para histerectomía
Pinces à hystérectomie
Pinze per isterectomia



EI-667-25
Wertheim Hysterectomy Forcep
Curved
Overall Length 26 cm (10 1/4")



EI-669-22
Curved
1 x 2 Teeth

EI-671-23
Curved
1 x 2 Teeth



Fergusson Angiotribe
Ophthalmologie Instrumente
Oftalmología Instrumentos
Ophthalmologie Instruments
Oftalmologia Strumenti



Fergusson Angiotribe

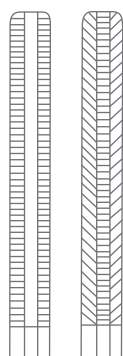

EI-680-16
Straight
16 cm (6 1/4")

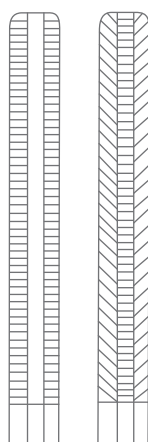

EI-680-20
Straight
20 cm (8")

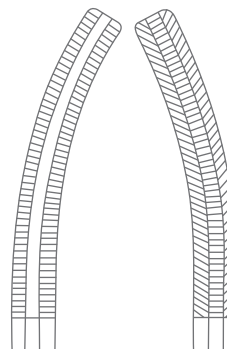

EI-681-16
Curved
16 cm (6 1/4")

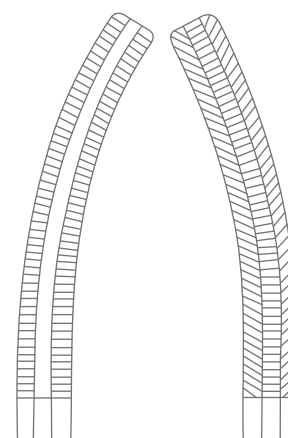

EI-681-20
Curved
20 cm (8")

Peritoneum Forceps
Peritoneumklemmen
Pinzas para peritoneo
Pince pour le péritoine
Pinze per peritoneo



EI-685-14
Mikulicz-Baby Peritoneum Forcep
Curved, 1 x 2 Teeth
Overall Length 14 cm (5 3/4")

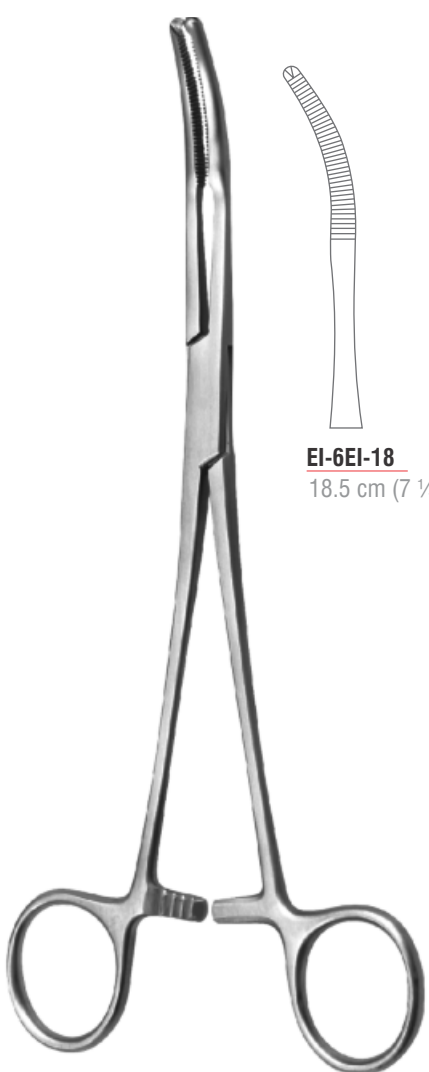

EI-6EI-18 18.5 cm (7 1/4")
EI-689-20 20 cm (8")
EI-691-20 20 cm (8")

Mikulicz Peritoneum Forcep
Curved, 1 x 2 Teeth



Peritoneum Forceps
Peritoneumklemmen
Pinzas para peritoneo
Pince pour le péritoine
Pinze per peritoneo



EI-693-24
Mikulicz Peritoneum Forcep
Curved, Longitudinal Serrations, 1 x 2 Teeth
Overall Length 24.5 cm (9 3/4")

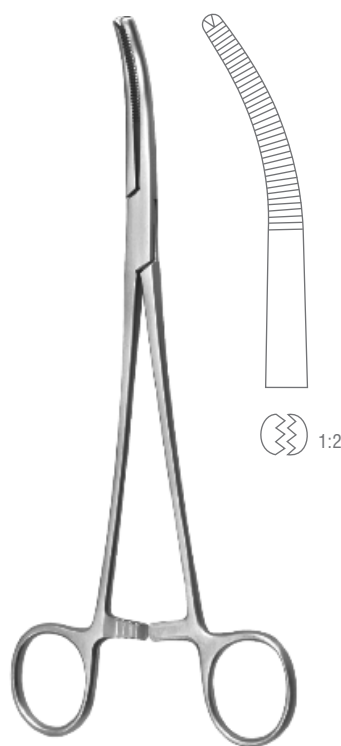

EI-693-24
Mikulicz Peritoneum Forcep
Curved, 1 x 2 Teeth
Overall Length 20.5 cm (8")

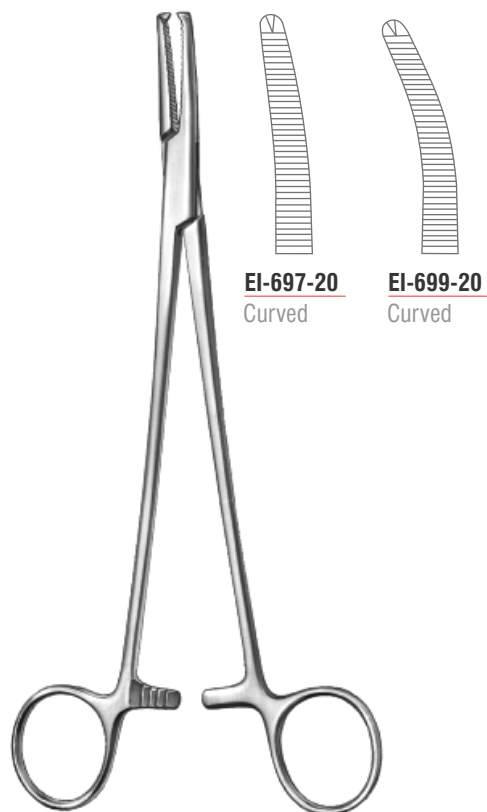

Faure Peritoneum Forcep
Overall Length 21 cm (8 1/4")

Towel Clamps
Tuchklemmen
Pinzas de campo
Pinces à champs
Pinze fissatele



EI-751-18
Doyen Towel Clamp
Overall Length 18 cm (7")



EI-755-09
Schaedel Towel Clamp
Sharp
Overall Length 9 cm (3 1/2")



Jones Towel Clamp
Sharp

EI-761-05
5.5 cm (2 1/2")

EI-761-09
8.5 cm (3 1/4")



EI-765-09
Martin-Jones Towel Clamp
Sharp, With Cable Holder
Overall Length 8.5 cm (3 1/4")



EI-769-01
For Cable Up To 5 mm

EI-769-02
For Cable Up To 13 mm

Robin Towel Clamp
With Cable Holder
Overall Length 13.5 cm (5 1/4")

Towel Clamps
Tuchklemmen
Pinzas de campo
Pincès à champs
Pinze fissatele



EI-771-11
Backhaus Towel Clamp
With Tube Holder
Overall Length 13 cm (5")



Backhaus Towel Clamp



EI-7EI-08
9 cm (3 1/2")

EI-7EI-11
11.5 cm (4 1/2")

EI-7EI-13
13 cm (5")

EI-7EI-15
16 cm (6 1/4")



EI-7EI-13
Roeder Towel Clamp
Overall Length 13.5 cm (5 1/4")



Lorna Towel Clamp
Fine Serrated, Wide Jaw

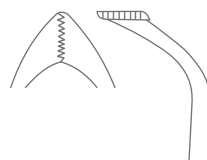

EI-781-10
9.5 cm (3 3/4")

EI-781-13
13 cm (5")

Towel Clamps
Tuchklemmen
Pinzas de campo
Pinces à champs
Pinze fissatele



EI-785-16
Bernhard Towel Clamp
Overall Length 16.5 cm (6 1/2")



EI-7EI-10
10.5 cm (4")
EI-7EI-13
13.5 cm (5 1/4")

Tohoku Towel Clamp
Blunt



EI-791-10
10 cm (4")
EI-791-13
13.5 cm (5 1/4")

Non Perforating Towel Clamp

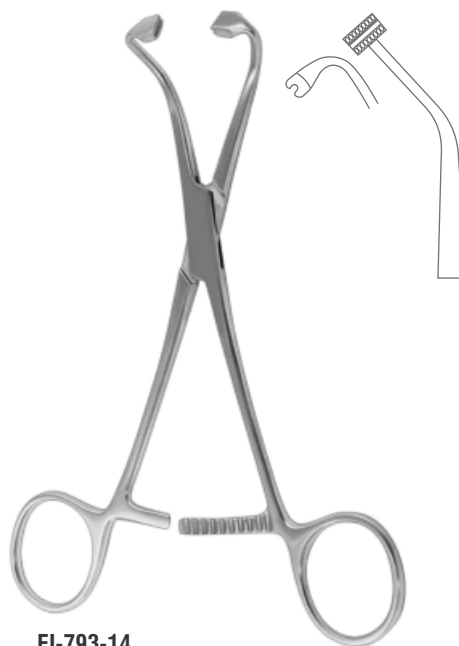

EI-793-14
Peers-Bertram Towel Clamp
With Jaw for Tube Fixation
Overall Length 16.5 cm (6 1/2")



Towel Clamps, Tubing Clamps
Tuchklemmen, Schlauchklemmen
Pinzas de campo, Pinzas para tubos
Pinces à champs, Pinces presse-tubes
Pinze fissatele, Pinze serratubi



Towel Clamp
For Paper Clothes

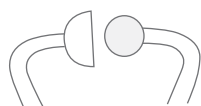

EI-795-11
11.5 cm (4 1/2")

EI-795-14
14 cm (5 1/2")



Lane Towel Clamp



EI-799-13
13 cm (5")

EI-799-15
15.5 cm (6")

EI-799-20
19.5 cm (7 3/4")



EI-801-19
Moynihan Towel Clamp
2 x 2 Teeth
Overall Length 19 cm (7 1/2")



EI-850-14
Klinikum-Berlin Tubing Clamp
Extra Long Ratchet
Overall Length 14 cm (5 1/2")



Presbyterian Tubing Clamp

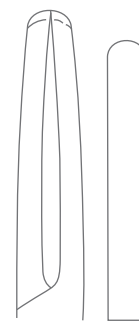

EI-852-16
16.5 cm (6 1/2")

EI-852-18
18 cm (7")

Tubing Clamps
Schlauchklemmen
Pinzas para tubos
Pincas presse-tubes
Pinze serratubi



Tubing Clamp

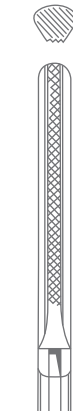

EI-860-15
15.5 cm (6")

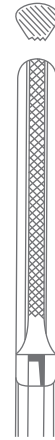

EI-860-18
19 cm (7 1/2")

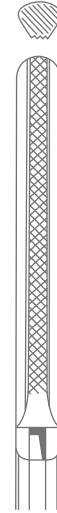

EI-860-20
20.5 cm (8")



Tubing Clamp
With Safety Guard

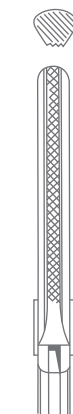

EI-862-15
15.5 cm (6")

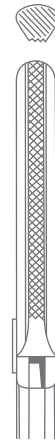

EI-862-18
19 cm (7 1/2")

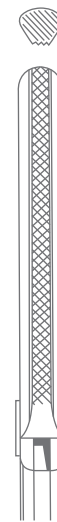

EI-862-20
20.5 cm (8")

Tube Milking Rollers
Rollenklemmen
Pinzas de rodillos
Pinces à roulette
Pinze con rotelle



EI-890-00
Brompton Tube Milking Roller
Standard



Dressing Forceps
Tupferzangen
Pinzas para tapones
Pincers à tampons
Pinze per tamponi

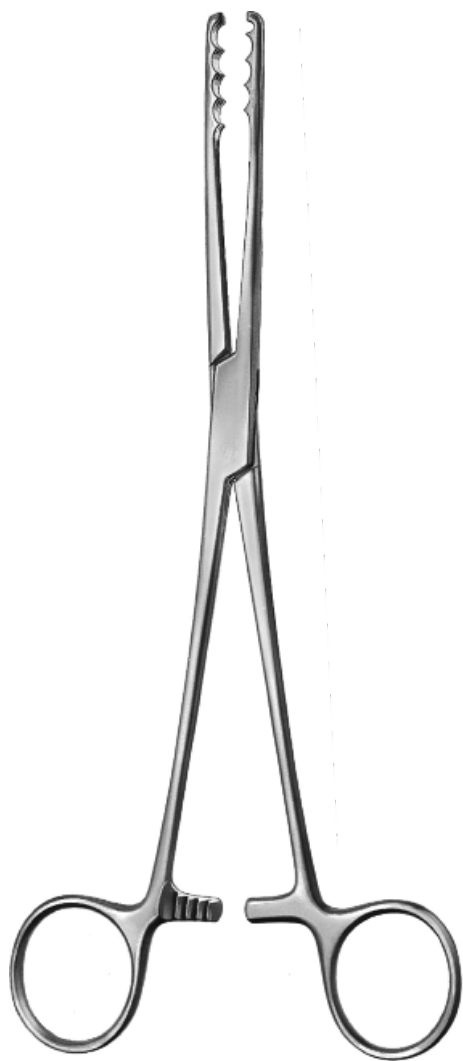

Ulrich Dressing Forcep

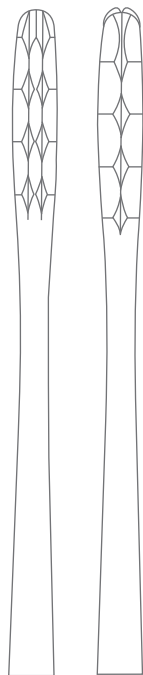

EI-100-22
Straight
22.5 cm (8 ¾")

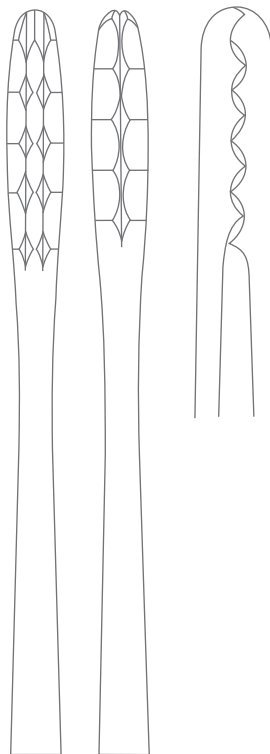

EI-100-27
Straight
26.5 cm (10 ½")



EI-101-22
Curved
22.5 cm (8 ¾")



EI-101-27
Curved
26.5 cm (10 ½")

Dressing Forceps
Tupferzangen
Pinzas para tapones
Pincas à tampons
Pinze per tamponi



EI-111-13
Bryant Dressing Forcep
Curved
Overall Length 13 cm (5")



Lister Sinus Forcep

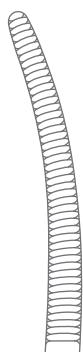

EI-120-13
Straight
13 cm (5")



EI-120-16
Straight
16 cm (6 1/4")



EI-120-18
Straight
18 cm (7")



EI-121-18
Curved
18 cm (7")

EVA

COTTON SWAB AND DRESSING FORCEPS



Dressing Forceps
Tupferzangen
Pinzas para tapones
Pinces à tampons
Pinze per tamponi



Martin Dressing Forcep

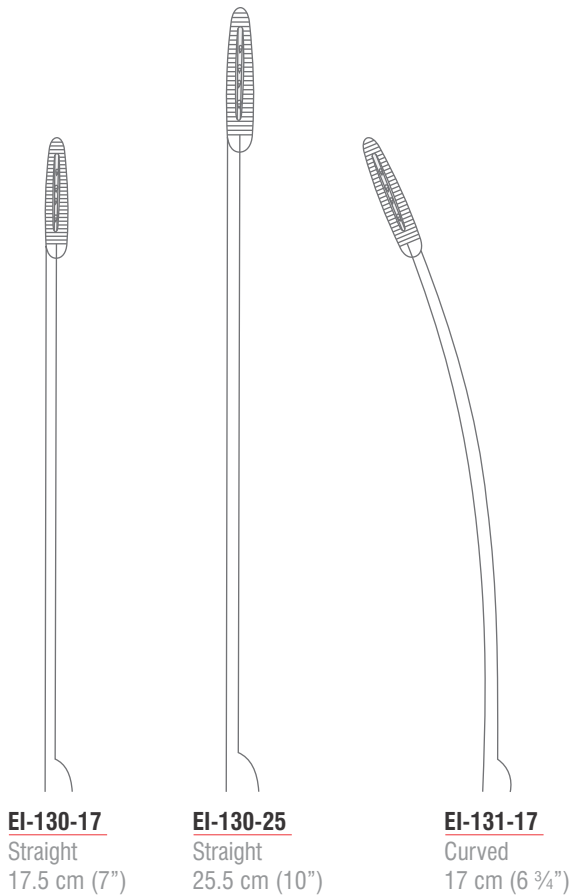

EI-130-17
Straight
17.5 cm (7")

EI-130-25
Straight
25.5 cm (10")

EI-131-17
Curved
17 cm (6 3/4")

Dressing Forceps
Tupferzangen
Pinzas para tapones
Pincès à tampons
Pinze per tamponi

EVA

COTTON SWAB AND DRESSING FORCEPS



Gross-Maier Dressing Forcep



EI-150-20
Straight
With Ratchet
20.5 cm (8")

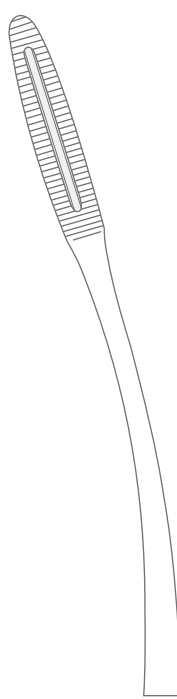

EI-151-20
Curved
With Ratchet
20 cm (8")



EI-152-20
Straight
Without Ratchet
20.5 cm (8")

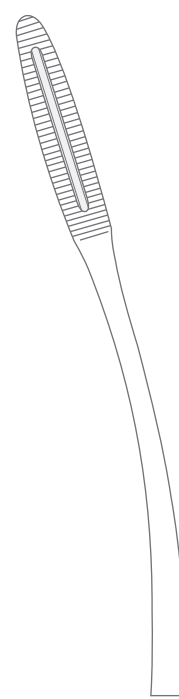

EI-153-20
Curved
Without Ratchet
20.5 cm (8")

EI-150-22
Straight
With Ratchet
22 cm (8 3/4")

EI-151-22
Curved
With Ratchet
21.5 cm (8 1/2")

EI-152-22
Straight
Without Ratchet
22 cm (8 3/4")

EI-153-22
Curved
Without Ratchet
22 cm (8 3/4")

EI-150-27
Straight
With Ratchet
26.5 cm (10 1/2")

EI-151-27
Curved
With Ratchet
26 cm (10 1/4")

EI-152-27
Straight
Without Ratchet
26.5 cm (10 1/2")

EI-153-27
Curved
Without Ratchet
26.5 cm (10 1/2")



Dressing Forceps
Tupferzangen
Pinzas para tapones
Pinces à tampons
Pinze per tamponi



Pelkmann Foreign Body Forcep
Overall Length 26 cm (10 1/4")

EI-160-26
Straight

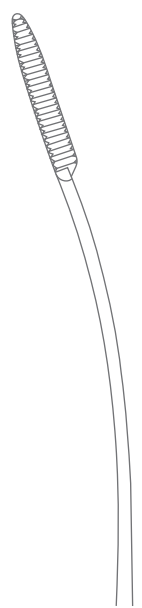

EI-161-26
Curved



Duplay Sponge Holding Forcep
Overall Length 21 cm (8 1/4")

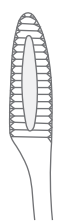

EI-164-21
Straight

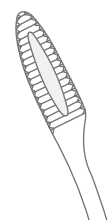

EI-165-21
Curved

Dressing Forceps
Tupferzangen
Pinzas para tapones
Pincès à tampons
Pinze per tamponi

EVA

COTTON SWAB AND DRESSING FORCEPS

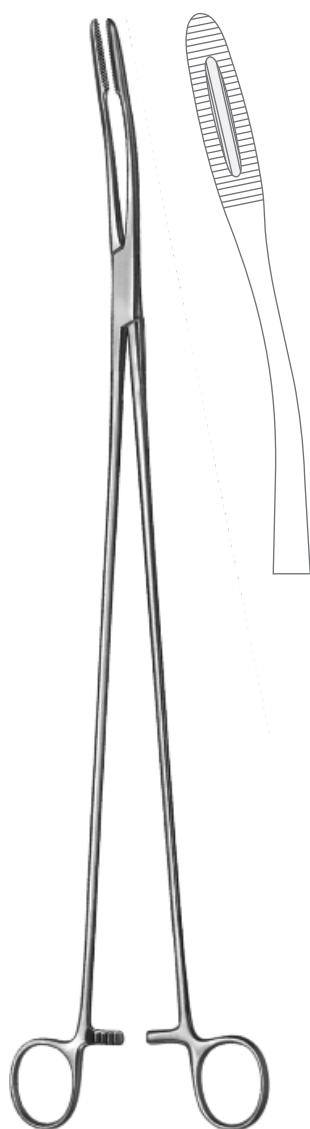

EI-171-40
Tunneling Forcep
Curved
Overall Length 39.5 cm (15 ½")

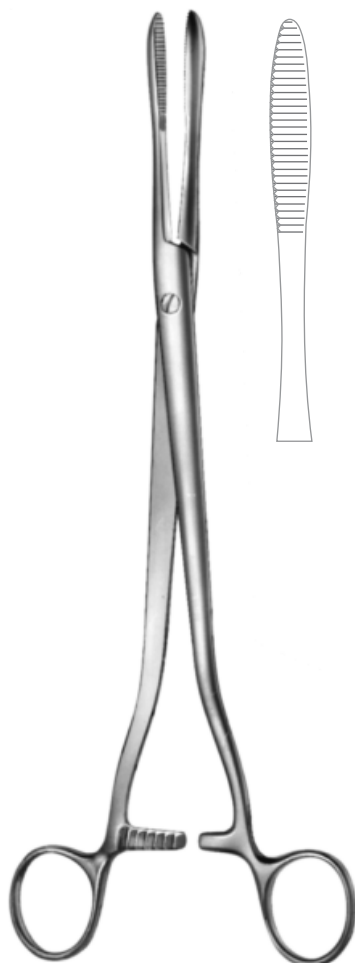

EI-180-25
Collin Dressing Forcep
Straight
Overall Length 25.5 cm (10")

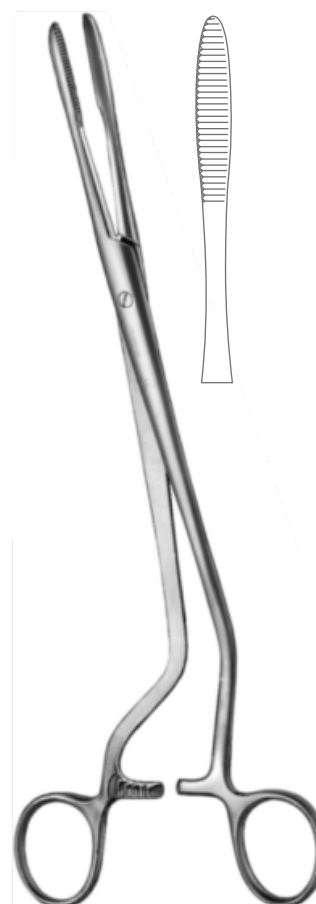

EI-191-25
Cheron Dressing Forcep
Straight
Overall Length 23.5 cm (9 ¼")

Dressing Forceps
Tupferzangen
Pinzas para tapones
Pinces à tampons
Pinze per tamponi



EI-196-21
Emmet Dressing Forcep
Straight
Overall Length 21 cm (8 1/4")

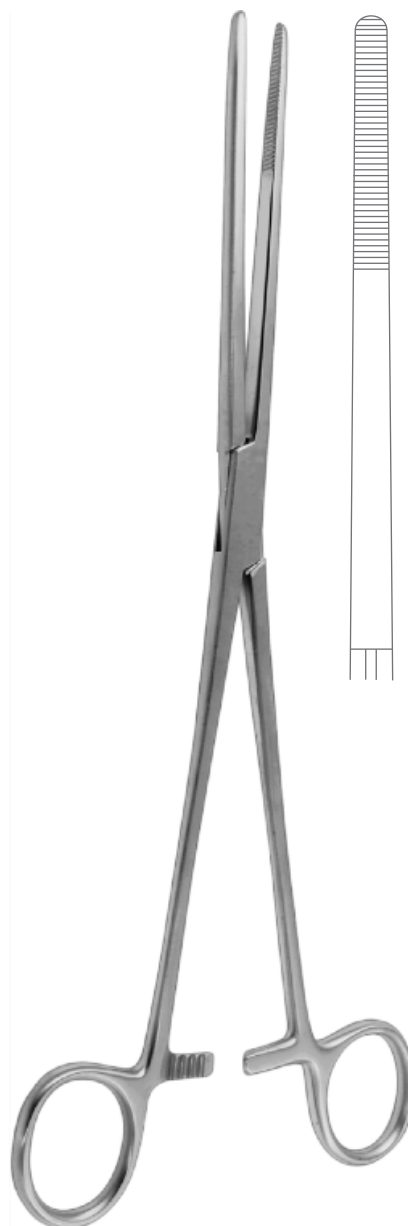

EI-200-26
Bozemann Sponge Holding Forcep
Straight
Overall Length 26 cm (10 1/4")

Dressing Forceps
Tupferzangen
Pinzas para tapones
Pinces à tampons
Pinze per tamponi

EVA

COTTON SWAB AND DRESSING FORCEPS

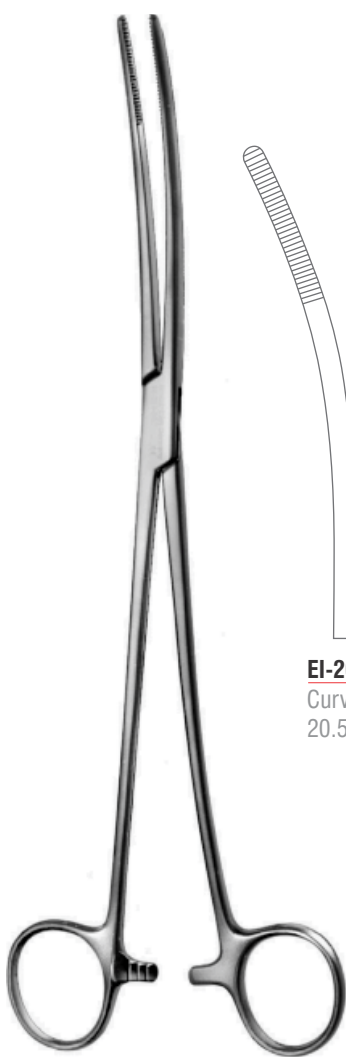

EI-201-20
Curved
20.5 cm (8")

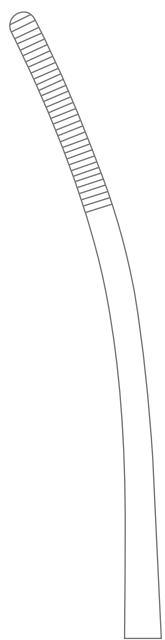

EI-201-26
Curved
26.5 cm (10 1/2")

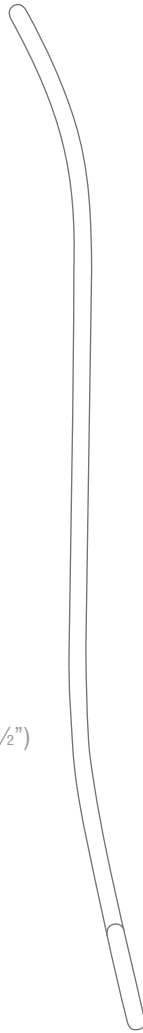

EI-203-26
Bozemann-Douglas Sponge Holding Forcep
Curved, S Shaped
Overall Length 26 cm (10 1/4")



Dressing Forceps
Tupferzangen
Pinzas para tapones
Pinces à tampons
Pinze per tamponi



EI-220-20
Heywood-Smith Sponge Holding Forcep
Straight
Overall Length 20 cm (8")



EI-222-21
Heywood-Smith Sponge Holding Forcep
Straight
Overall Length 21 cm (8 1/4")

Dressing Forceps
Tupferzangen
Pinzas para tapones
Pincès à tampons
Pinze per tamponi

EVA

COTTON SWAB AND DRESSING FORCEPS



EI-231-24
Mcclintock Ovum Forcep
Overall Length 24 cm (9 ½")



EI-250-24
Bergmann Sponge Holding Forcep
Straight
Overall Length 24 cm (9 ½")

Dressing Forceps
Tupferzangen
Pinzas para tapones
Pinces à tampons
Pinze per tamponi



Foerster Sponge Holding Forcep



EI-300-25
Straight
Smooth Jaws
25 cm (9 3/4")

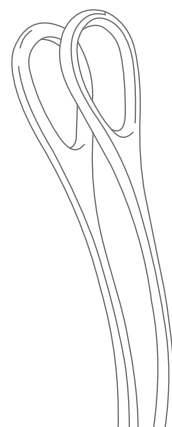

EI-301-25
Curved
Smooth Jaws
25 cm (9 3/4")

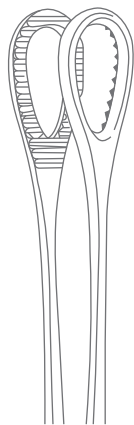

EI-350-18
Straight
18 cm (7")

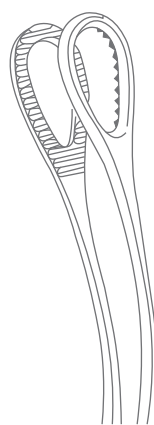

EI-351-18
Curved
18 cm (7")

EI-350-20
Straight
20.5 cm (8")

EI-351-20
Curved
20.5 cm (8")

EI-350-25
Straight
25 cm (9 3/4")

EI-351-25
Curved
24.5 cm (9 3/4")

Dressing Forceps
Tupferzangen
Pinzas para tapones
Pincers à tampons
Pinze per tamponi

EVA

COTTON SWAB AND DRESSING FORCEPS



Foerster Sponge Holding Forcep



EI-360-25
Straight
25 cm (9 3/4")

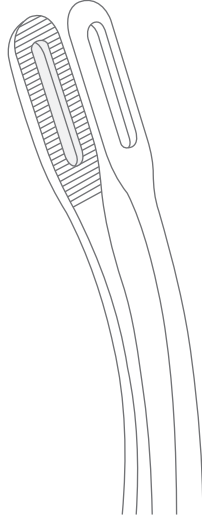

EI-361-25
Curved
24.5 cm (9 3/4")

Operating Scissors
Chirurgische Scheren
Tijeras quirúrgicas
Ciseaux chirurgicaux
Forbici per chirurgia

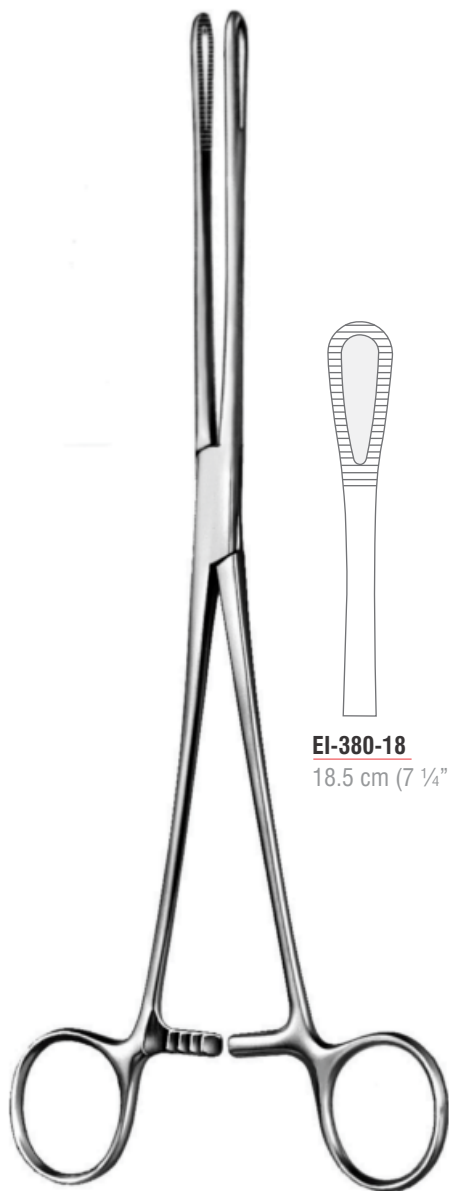

Rampley Sponge Holding Forcep
Straight



EI-380-18
18.5 cm (7 1/4")

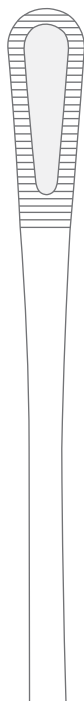

EI-380-25
24.5 cm (9 3/4")

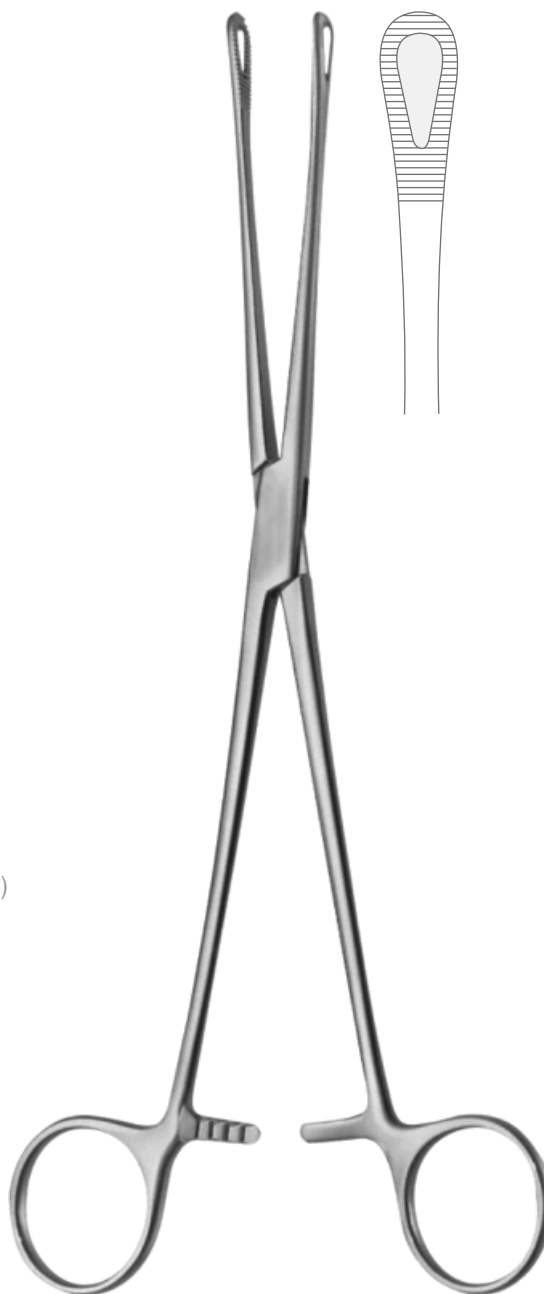

EI-384-24
Bonney Sponge Holding Forcep
Straight
Overall Length 24.5 cm (9 1/2")



Micro Hooklets, Skin Hooks
 Mikrohäkchen, Hauthäkchen
 Micro Ganchitos, Ganchitos de piel
 Micro Crochetes, Crochetes pour le peau
 Micro Divaricatori, Divaricatori per pelle



EI-012-01
Fig. 1

EI-012-02
Fig. 2

Gillies Skin Hook
Overall Length 18 cm (7")



EI-014-15
Kilner Skin Hook
Sharp
Overall Length 14.5 cm (5 3/4")



EI-016-01
Sharp
13 cm (5")

EI-016-02
Blunt
13 cm (5")

EI-016-03
Sharp
18 cm (7")

EI-016-04
Blunt
18 cm (7")

Frazier Delicate Hook

Micro Hooklets, Skin Hooks
 Mikrohäkchen, Hauthäkchen
 Micro Ganchitos, Ganchitos de piel
 Micro Crochetes, Crochetes pour le peau
 Micro Divaricatori, Divaricatori per pelle



KleineEI-Kutz Delicate Hook
 Overall Length 16 cm (6 1/4")



Graefe Delicate Hook
 Overall Length 15 cm (6")



Skin Hook
 Overall Length 16 cm (6 1/4")

Skin Hooks, Hooklets
 Hauthäkchen, Wundhäkchen
 Ganchitos de piel, Ganchitos
 Crochetes pour le peau, Crochetes
 Divaricatori per pelle, Divaricatori



EI-030-16
O'Connor Skin Hook
 Sharp
 Overall Length 16 cm (6 1/4")



EI-0EI-15
Joseph Mucus Hook
 Sharp
 Overall Length 15.5 cm (6")



EI-036-16
Cottle Nasal Hook
 Sharp
 Overall Length 17 cm (6 3/4")



EI-038-01
 Fig. 1

EI-038-02
 Fig. 2

EI-038-03
 Fig. 3

Cottle Nasal Hook
 Sharp
 Overall Length 14.5 cm (5 3/4")

Nerve Hooks
Nervhaken
Ganchos para nervios
Crochets à nerfs
Uncini per nervi



Cushing Nerve Hook
Blunt

EI-040-01

Fig. 1
19 cm (7 1/2")

EI-042-01

Fig. 1
28 cm (11")



EI-040-02

Fig. 2
19.5 cm (7 3/4")

EI-042-02

Fig. 2
28.5 cm (11")



Graefe Nerve Hook
Blunt
Overall Length 14 cm (5 1/2")



EI-048-01

Fig. 1



EI-048-02

Fig. 2



EI-048-03

Fig. 3

Nerve Hooks
Nervhaken
Ganchos para nervios
Crochets à nerfs
Uncini per nervi



Crile Nerve Hook



EI-050-14
Angled 90°
Ø 1.4 mm
14.5 cm (5 ¾")



EI-050-20
Angled 90°
Ø 1.4 mm
20 cm (8")



EI-052-20
Angled 30°
Ø 1.4 mm
20.5 cm (8")



EI-054-02
EIF Nerve & Vessel Hook
With Sharp Cutting Edge
Tip Size 2.0 mm
Overall Length 24 cm (9 ½")



EI-056-25
Drake Nerve & Vessel Hook
Calibrated
Overall Length 25.5 cm (10")

Skin Hooks, Hooklets
Hauthäkchen, Wundhäkchen
Ganchitos de piel, Ganchitos
Crochetes pour le peau, Crochetes
Divaricatori per pelle, Divaricatori



Guthrie Skin Retractor
Sharp
Overall Length 15.5 cm (6")



EI-060-01
2.0 mm



EI-060-02
3.0 mm



EI-062-13
Rollet Fine Wound Retractor
2 Sharp Prongs, 4.5 mm
Overall Length 13 cm (5")



EI-064-01
7.0 mm
4 Sharp
Prongs



EI-064-02
7.0 mm
4 Blunt
Prongs

Skin Hooks, Hooklets
 Hauthäkchen, Wundhäkchen
 Ganchitos de piel, Ganchitos
 Crochetes pour le peau, Crochetes
 Divaricatori per pelle, Divaricatori



EI-066-13
4 Sharp Prongs

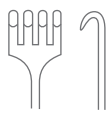

EI-068-13
4 Blunt Prongs



EI-070-01
9 mm



EI-070-02
10 mm

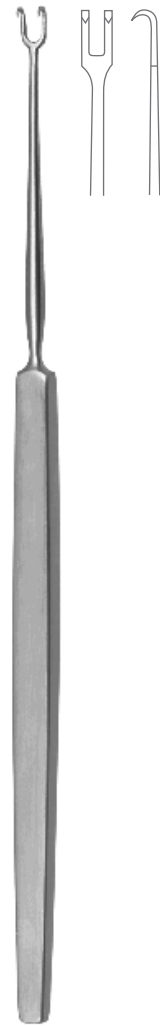

EI-072-15
Freer Mucus Hook
Sharp, 3.2
Overall Length 15 cm (6")

Skin Hooks, Hooklets
 Hauthäkchen, Wundhäkchen
 Ganchitos de piel, Ganchitos
 Crochetes pour le peau, Crochetes
 Divaricatori per pelle, Divaricatori



Joseph Mucus Hook
 Overall Length 16.5 cm (6 1/2")



EI-074-02
 2.0 mm



EI-074-05
 5.0 mm



EI-074-07
 7.0 mm



EI-074-10
 10.0 mm



EI-076-10
Kilner Alar Hook
 Sharp
 Overall Length 8 cm (3 1/4")

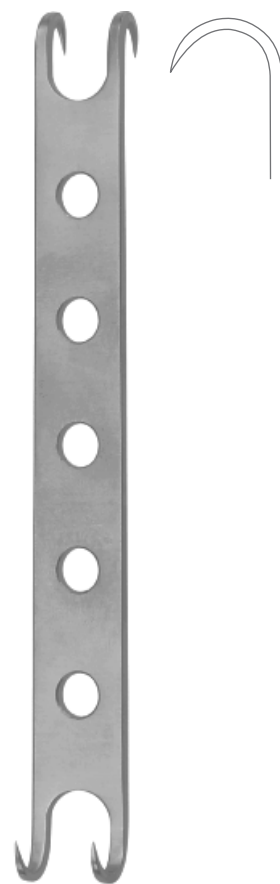

EI-0EI-12
Converse Alar Hook
 Sharp
 Overall Length 11.5 cm (4 1/2")

Hooklets
Wundhäkchen
Ganchitos
Crochetes
Divaricatori



EI-080-14
Cottle Alar Hook
4 Semi Sharp Prongs
Overall Length 14 cm (5 ½")

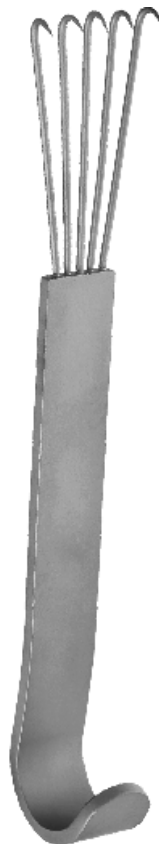

EI-082-05
Anderson Claw Retractor
5 Sharp Prongs
Overall Length 12 cm (4 ¾")



EI-084-18
Tissue Picker
2 Twisted Sharp Prongs, Ø 1.8 mm
Overall Length 18.5 cm (7 ¼")

Hooklets
Wundhäkchen
Ganchitos
Crochetes
Divaricatori



Wound Retractor
Small Curved
Overall Length 16.5 cm (6 1/2")



Hooklets
Wundhäkchen
Ganchitos
Crochetes
Divaricatori



Wound Retractor
Flexible Prongs
Overall Length 16 cm (6 ¼")



EI-104-02
Sharp



EI-104-03
Sharp



EI-104-04
Sharp



EI-105-02
Blunt



EI-105-03
Blunt



EI-105-04
Blunt



Wound Retractor
Overall Length 16.5 cm (6 ½")



EI-108-01
Sharp



EI-108-02
Blunt

Hooklets
Wundhäkchen
Ganchitos
Crochetes
Divaricatori



EI-110-12
Moldestad Vessel Hook
Overall Length 12 cm (4 3/4")

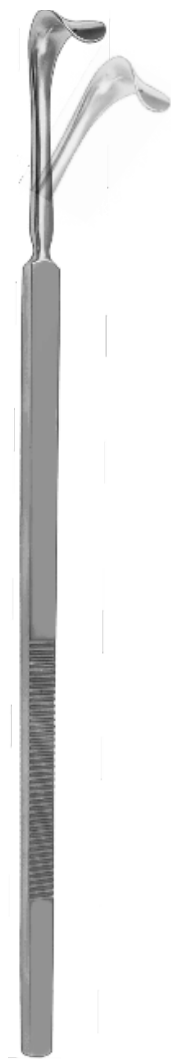

Kirclin Lid Retractor
Malleable
Overall Length 13 cm (5 1/4")



EI-118-05
8 x 5 mm



EI-118-07
9 x 7 mm



EI-118-10
9 x 10 mm



EI-118-12
9 x 12 mm

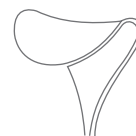

EI-118-15
10 x 15 mm

Hooklets
Wundhäkchen
Ganchitos
Crochetes
Divaricatori

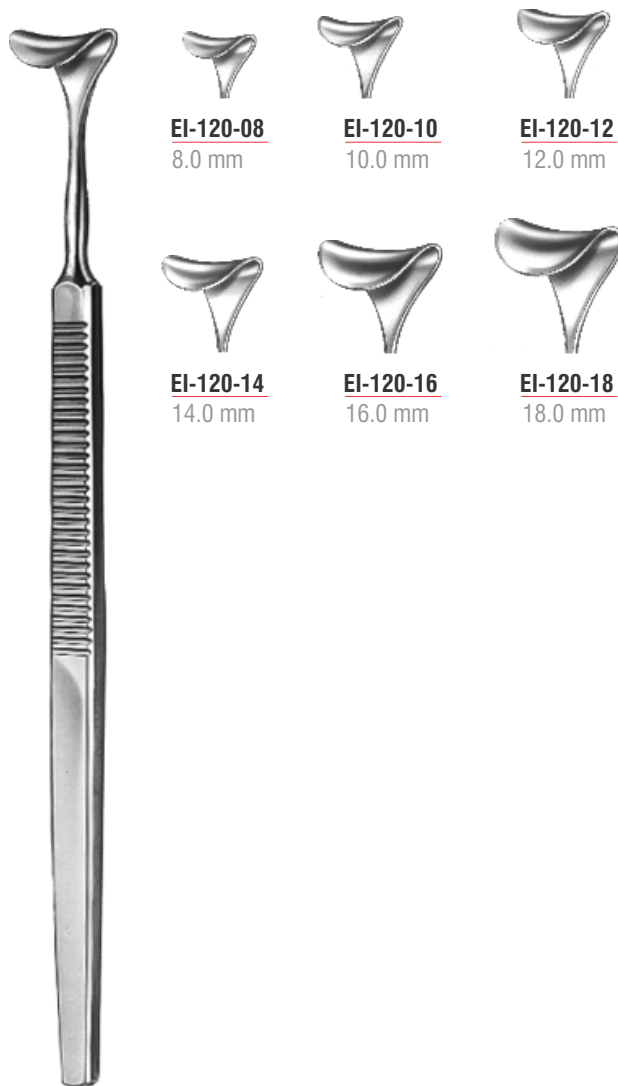

Desmarres Lid Retractor
Overall Length 16 cm (6 ¼")

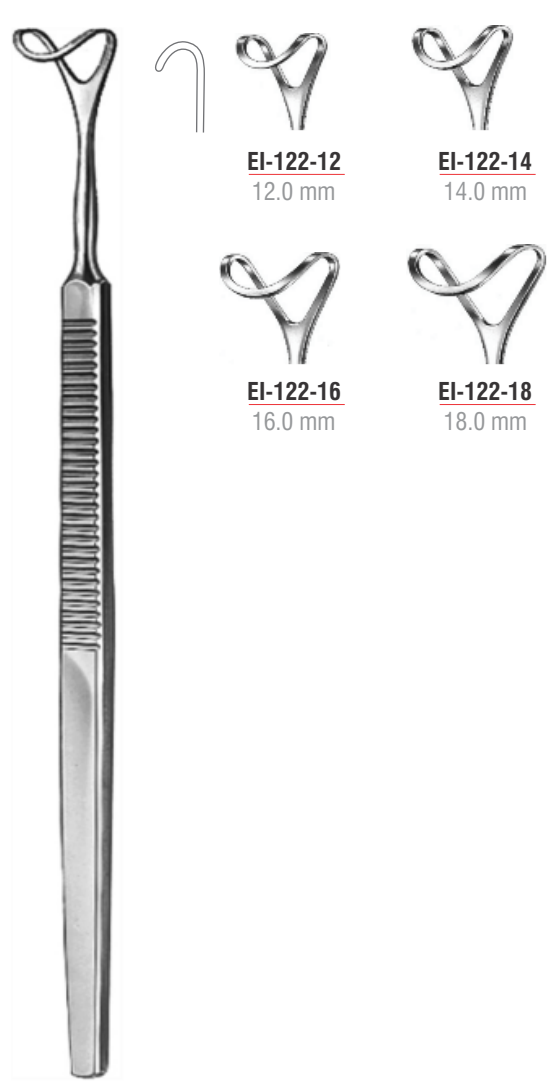

Lid Retractor
Hollow Blade
Overall Length 16 cm (6 ¼")

Hooklets
Wundhäkchen
Ganchitos
Crochetes
Divaricatori



EI-124-14
Masing Lid Retractor
12.0 mm
Overall Length 14 cm (5 1/2")



Mini-Langenbeck Retractor
Overall Length 16 cm (6 1/4")



EI-130-10
10 x 6 mm



EI-130-17
17 x 5 mm



EI-130-20
20 x 6 mm



EI-130-22
22 x 8 mm

Hooklets
Wundhäkchen
Ganchitos
Crochetes
Divaricatori



EI-132-16
16 x 6 mm

EI-132-24
24 x 6 mm

Langenbeck-Green Retractor
Overall Length 16 cm (6 1/4")



EI-1EI-16
Mannerfelt Modified Tendon Hook
Overall Length 16 cm (6 1/4")



EI-136-16
Wound Retractor
Two Blunt Prongs
14 x 8 mm
Overall Length 16 cm (6 1/4")

Hooklets
Wundhäkchen
Ganchitos
Crochetes
Divaricatori



Wound Retractor
Large Curved
Overall Length 16.5 cm (6 1/2")



EI-140-01
Sharp Prong



EI-140-02
Sharp Prongs
7.5 mm

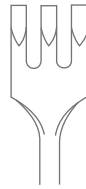

EI-140-03
Sharp Prongs
10.0 mm

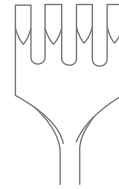

EI-140-04
Sharp Prongs
14.0 mm



EI-141-01
Sharp Blunt



EI-141-02
Blunt Prongs
7.5 mm



EI-141-03
Blunt Prongs
10.0 mm

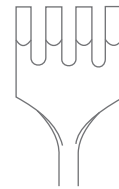

EI-141-04
Blunt Prongs
14.0 mm

Hooklets
Wundhäkchen
Ganchitos
Crochetes
Divaricatori



Meyerding Retractor
Overall Length 17.5 cm (7")



EI-150-01
Blunt
18 x 7 mm

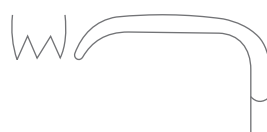

EI-150-02
Toothed
16 x 5 mm



EI-150-03
Toothed
17 x 4 mm

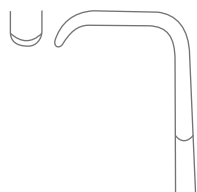

EI-150-04
Blunt
10 x 3 mm

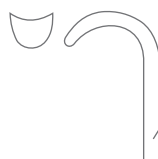

EI-150-05
Saddle Shaped
7 x 4 mm

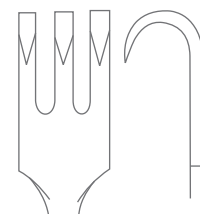

EI-150-06
3 Sharp Prongs
10 x 4 mm

Hooklets
Wundhäkchen
Ganchitos
Crochetes
Divaricatori



Senn-Green Retractor
Overall Length 15 cm (6")



EI-156-01
Fig. 1
20 x 6 mm



EI-156-02
Fig. 2
10 x 6 mm



EI-158-14
Ragnell-Davis Retractor
8 x 4 mm - 15 x 5.5 mm
Overall Length 14 cm (5 1/2")

Hooklets
Wundhäkchen
Ganchitos
Crochetes
Divaricatori



EI-160-16
Kilner Retractor
Sharp, 13 x 5 mm
Overall Length 16 cm (6 1/2")



Senn-Miller Retractor
Overall Length 16 cm (6 1/2")

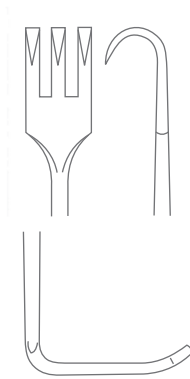

EI-162-16
Sharp
20 x 7 mm

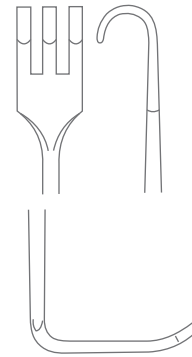

EI-163-16
Blunt
20 x 7 mm

Hooklets
Wundhäkchen
Ganchitos
Crochetes
Divaricatori



EI-170-20
Cushing Retractor/Saddle Hook
Overall Length 20.5 cm (8")

Saddle Hooks
Sattelhäkchen
Ganchos en forma de silla
Ecarteurs sous forme de selle
Divaricatori a forma di sella



EI-172-08
8.0 mm



EI-172-10
10.0 mm



EI-172-12
12.0 mm



EI-172-14
14 mm



EI-172-16
16 mm



EI-172-18
18 mm

Cushing Retractor/Saddle Hook
Overall Length 20.5 cm (8")



EI-174-08
8.0 mm



EI-174-10
10.0 mm



EI-174-12
12.0 mm



EI-174-14
14 mm



EI-174-16
16 mm



EI-174-18
18 mm

Cushing Retractor/Saddle Hook
Overall Length 24 cm (9 1/2")

Saddle Hooks, Vein Hooks
 Sattelhäkchen, Venenhäkchen, Wundhäkchen
 Ganchos en forma de silla, Ganchitos para venas
 Ecarteurs sous forme de selle, Ecarteurs pour veines
 Divaricatori a forma di sella, Divaricatori per venia



Gil-Vernet Retractor/Saddle Hook
 Overall Length 24 cm (9 1/2")



EI-176-08
 8.0 mm



EI-176-11
 11.0 mm



EI-176-15
 15.0 mm



EI-176-17
 17.0 mm



EI-176-20
 20.0 mm



EI-176-23
 23.0 mm



Brom Vein Hook
 Overall Length 19.5 cm (7 3/4")



EI-1EI-01



EI-1EI-02

Vein Hooks
Wundhäkchen
Ganchitos para venas
Ecarteurs pour veines
Divaricatori per venia



EI-180-01
Smooth

EI-180-02
Toothed

Strandell-Stille Retractor
Overall Length 19 cm (7 3/4")



EI-184-08
Kaye-Millard Retractor
Sharp
Overall Length 8 cm (3")



EI-190-01
2 Prongs
13 x 6 mm

EI-190-02
3 Prongs
12 x 11 mm

EI-190-03
4 Prongs
15 x 11 mm

Klapp Retractor
Blunt
Overall Length 17.5 cm (7")

Retractors
Wundhaken, Wundhäkchen
Separadores
Ecarteurs
Divaricatori



Volkmann Retractor
Hollow Handle
Overall Length 21.5 cm (8 1/2")

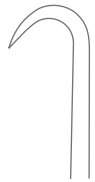

EI-200-01
Sharp
1 Prong



EI-200-02
Sharp
2 Prongs



EI-200-03
Sharp
3 Prongs

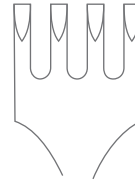

EI-200-04
Sharp
4 Prongs

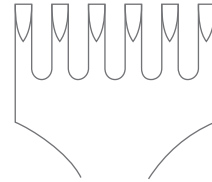

EI-200-06
Sharp
6 Prongs



EI-201-01
Blunt
1 Prong



EI-201-02
Blunt
2 Prongs



EI-201-03
Blunt
3 Prongs

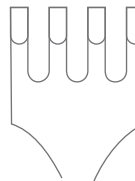

EI-201-04
Blunt
4 Prongs

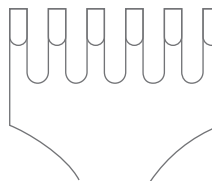











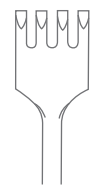
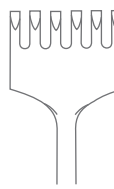

EI-201-06
Blunt
6 Prongs

Retractors
Wundhaken, Wundhäkchen
Separadores
Ecarteurs
Divaricatori

EVA

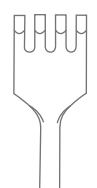
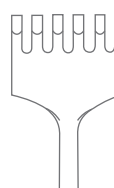
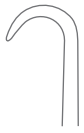
RETRACTORS

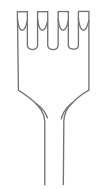
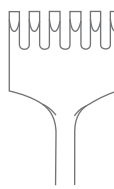

					
Sharp	EI-210-01 1 Prong	EI-210-02 2 Prongs	EI-210-03 3 Prongs	EI-210-04 4 Prongs	EI-210-06 6 Prongs
					
Blunt	EI-211-01 1 Prong	EI-211-02 2 Prongs	EI-211-03 3 Prongs	EI-211-04 4 Prongs	EI-211-06 6 Prongs
					
Semi Sharp	EI-212-01 1 Prong	EI-212-02 2 Prongs	EI-212-03 3 Prongs	EI-212-04 4 Prongs	EI-212-06 6 Prongs

Volkman Retractor
Overall Length 22 cm (8 3/4")

Retractors
Wundhaken, Wundhäkchen
Separadores
Ecarteurs
Divaricatori

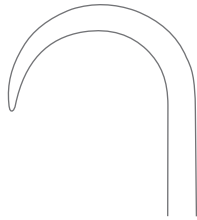

EI-214-01
Volkmann Retractor
Sharp, 1 Prong
Overall Length 21.5 cm (8 1/2")

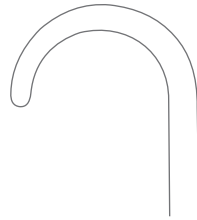

EI-215-01
Volkmann Retractor
Blunt, 1 Prong
Overall Length 21.5 cm (8 1/2")

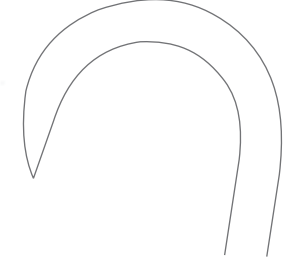

EI-218-01
Volkmann Retractor
Sharp, 1 Prong
Overall Length 21.5 cm (8 1/2")

Retractors
 Wundhaken, Wundhäkchen
 Separadores
 Ecarteurs
 Divaricatori

EVA

RETRACTORS



	Sharp									
		EI-220-01	EI-220-02	EI-220-03	EI-220-04	EI-220-06	EI-220-08			
		1 Prong	2 Prongs	3 Prongs	4 Prongs	6 Prongs	8 Prongs			
		Blunt								
			EI-221-01	EI-221-02	EI-221-03	EI-221-04	EI-221-06	EI-221-08		
			1 Prong	2 Prongs	3 Prongs	4 Prongs	6 Prongs	8 Prongs		
				Semi Sharp						
					EI-222-01	EI-222-02	EI-222-03	EI-222-04	EI-222-06	EI-222-08
					1 Prong	2 Prongs	3 Prongs	4 Prongs	6 Prongs	8 Prongs

Kocher Retractor
 Overall Length 22 cm (8 3/4")

Retractors
Wundhaken, Wundhäkchen
Separadores
Ecarteurs
Divaricatori



Murphy Retractor
Overall Length 19.5 cm (7 ¾")



EI-224-03
Sharp
3 Prongs



EI-224-04
Sharp
4 Prongs



EI-225-03
Blunt
3 Prongs



EI-225-04
Blunt
4 Prongs

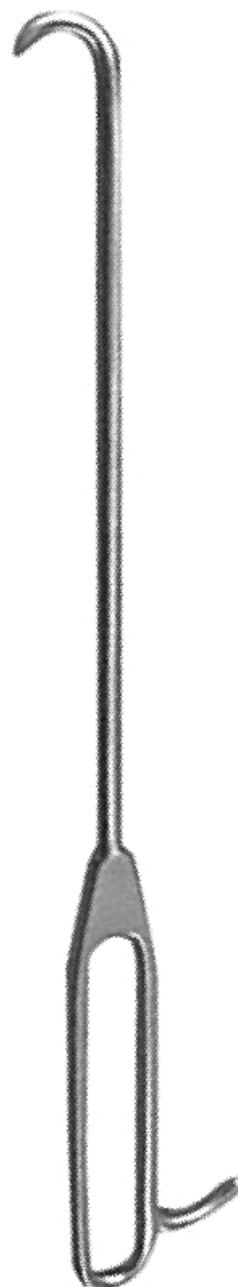

EI-226-27
Lambotte Bone Hook
Overall Length 27 cm (10 ½")

Retractors
Wundhaken, Wundhäkchen
Separadores
Ecarteurs
Divaricatori

EVA

RETRACTORS

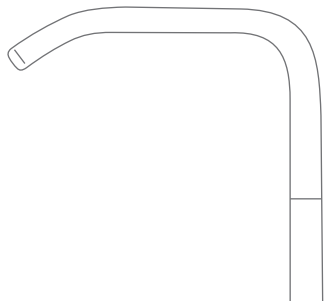

EI-231-03
Blunt
36 x 30 mm
3 Prongs

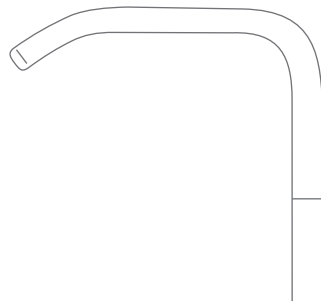

EI-231-04
Blunt
36 x 60 mm
4 Prongs

Ollier Retractor
Overall Length 23 cm (9")

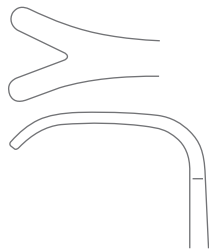

EI-235-02
Wassmund Retractor
33 x 21 mm
Overall Length 20.5 cm (8")

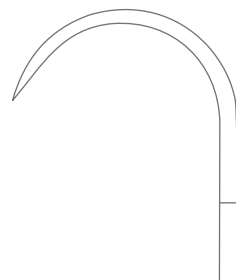

EI-238-08
Sharp, 8 Prongs
40 x 30 mm

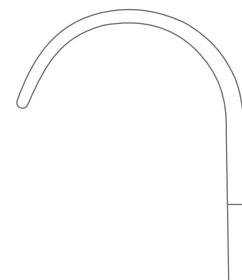

EI-239-08
Blunt, 8 Prongs
40 x 30 mm

Koerte Retractor
Overall Length 24.5 cm (9 3/4")

Retractors
Wundhaken, Wundhäkchen
Separadores
Ecarteurs
Divaricatori



Israel Retractor
Overall Length 25.5 cm (10")



EI-241-04
Blunt, 4 Prongs
40 x 40 mm

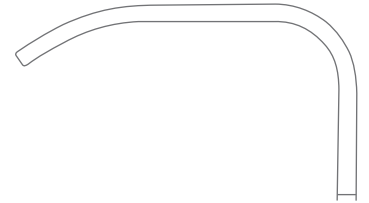

EI-243-05
Blunt, 5 Prongs
45 x 50 mm

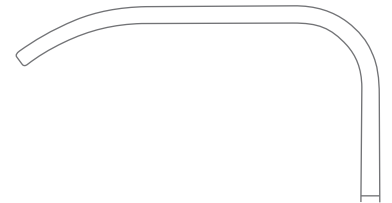

EI-245-06
Blunt, 6 Prongs
50 x 60 mm

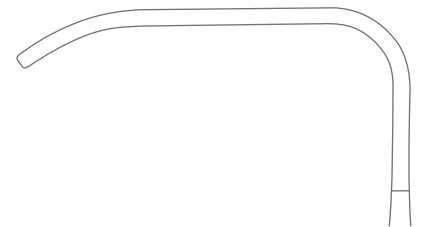

EI-247-07
Blunt, 7 Prongs
70 x 70 mm



Retractors
Wundhaken, Wundhäkchen
Separadores
Ecarteurs
Divaricatori

EVA

RETRACTORS



Langenbeck Retractor
Overall Length 22.5 cm (8 3/4")

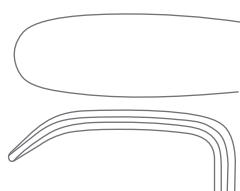

EI-251-01
30 x 11

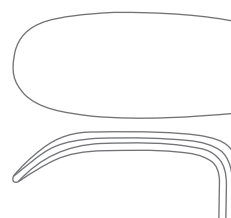

EI-251-02
30 x 14

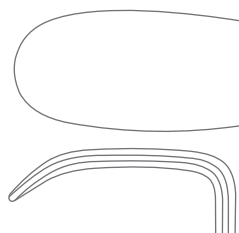

EI-251-03
30 x 16

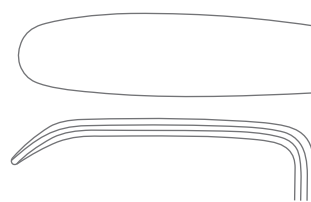

EI-251-04
40 x 11

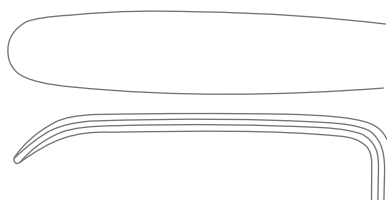

EI-251-05
50 x 11

Retractors
Wundhaken, Wundhäkchen
Separadores
Ecarteurs
Divaricatori



Langenbeck Retractor
Hollow Handle
Overall Length 22.5 cm (8 ¾")

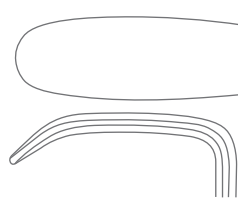

EI-253-01
30 x 11

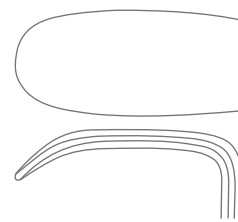

EI-253-02
30 x 14

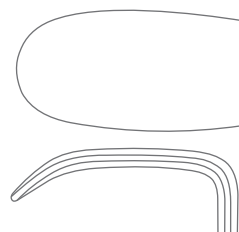

EI-253-03
30 x 16

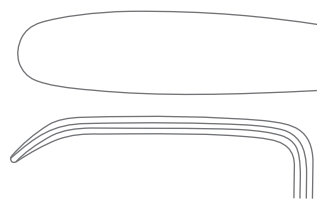

EI-253-04
40 x 11

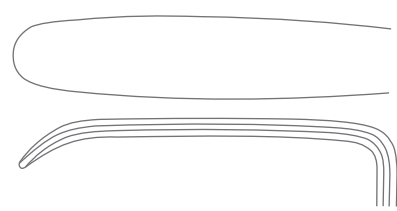

EI-253-05
50 x 11

Retractors
Wundhaken, Wundhäkchen
Separadores
Ecarteurs
Divaricatori

EVA

RETRACTORS



EI-255-00
Langenbeck Retractor
33 x 14
Overall Length 22.5 cm (8 ¾")



Langenbeck Retractor
Overall Length 21 cm (8 ¼")



EI-257-01
55 x 20 mm

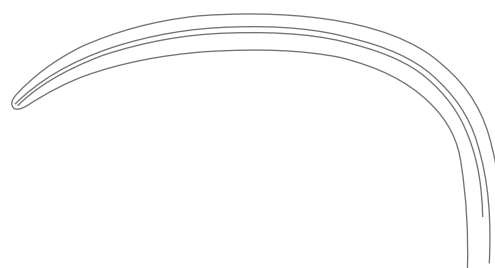

EI-257-02
60 x 20 mm



EI-257-03
63 x 20 mm

Retractors
Wundhaken, Wundhäkchen
Separadores
Ecarteurs
Divaricatori

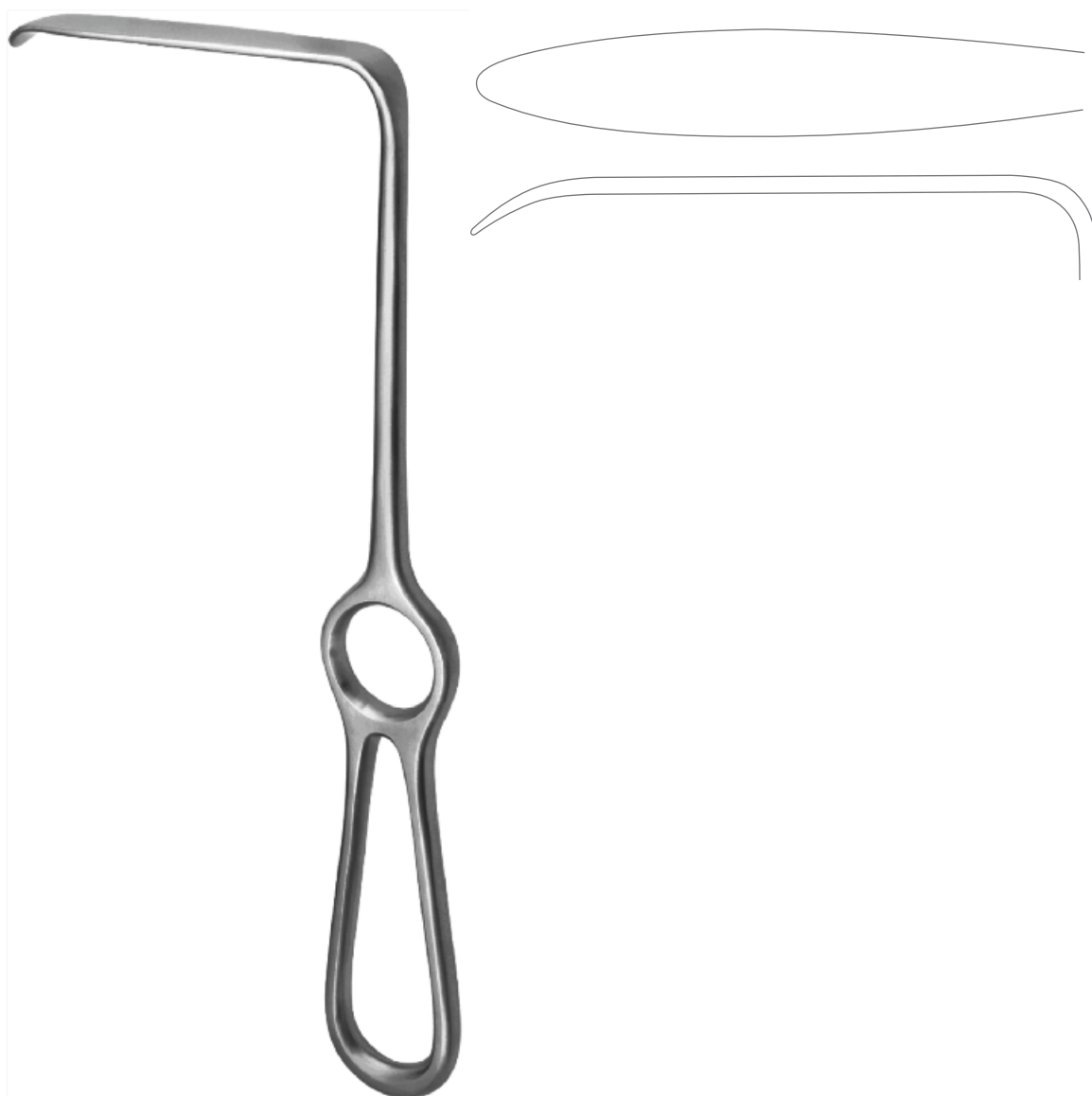

EI-259-22
Langenbeck Retractor
85 x 15 mm
Overall Length 22.5 cm (8 ¾")

Retractors
Wundhaken, Wundhäkchen
Separadores
Ecarteurs
Divaricatori

EVA

RETRACTORS

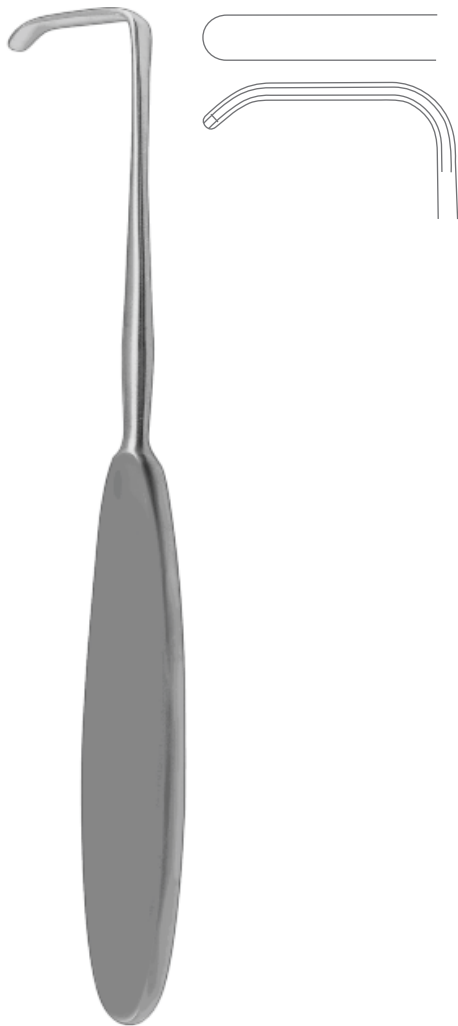

EI-271-19
Lahey Retractor
31 x 6 mm
Overall Length 19.5 cm (7 ¾")



EI-275-20
Little Retractor
13 x 15 mm
Overall Length 20 cm (8")

Retractors
Wundhaken, Wundhäkchen
Separadores
Ecarteurs
Divaricatori



Kocher Retractor
Overall Length 23 cm (9")

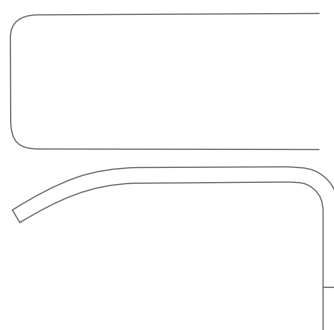

EI-281-18
41 x 18 mm

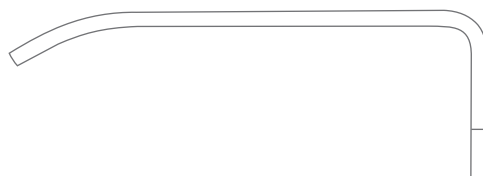

EI-281-20
61 x 20 mm

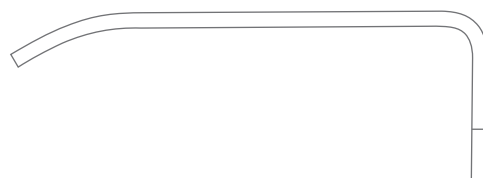

EI-281-25
61 x 25 mm

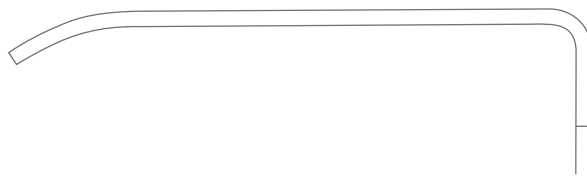

EI-281-30
75 x 30 mm



EI-281-40
75 x 40 mm

Retractors
Wundhaken, Wundhäkchen
Separadores
Ecarteurs
Divaricatori

EVA

RETRACTORS



Kocher-Langenbeck Retractor
Overall Length 21.5 cm (8 1/2")

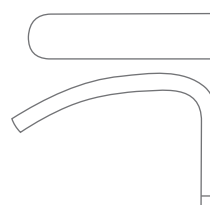

EI-291-01
25 x 6 mm

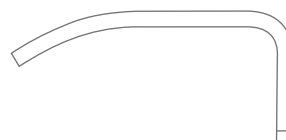

EI-291-02
35 x 8 mm

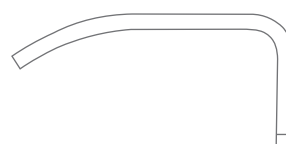

EI-291-03
35 x 11 mm

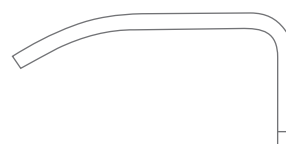

EI-291-04
35 x 15 mm

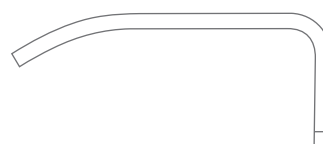

EI-291-05
40 x 11 mm



EI-291-06
55 x 11 mm



EI-291-07
70 x 14 mm



EI-291-08
80 x 12 mm



EI-291-09
80 x 16 mm

Retractors
Wundhaken, Wundhäkchen
Separadores
Ecarteurs
Divaricatori



Kocher-Langenbeck Retractor
Overall Length 21.5 cm (8 1/2")

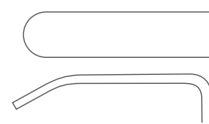

EI-293-01
25 x 10 mm



EI-293-02
40 x 13 mm



EI-293-03
60 x 13 mm



EI-293-04
40 x 18 mm



EI-293-05
60 x 18 mm



EI-293-06
85 x 18 mm



EI-293-07
60 x 25 mm



EI-293-08
85 x 25 mm

Retractors
Wundhaken, Wundhäkchen
Separadores
Ecarteurs
Divaricatori

EVA

RETRACTORS

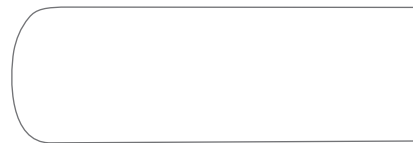

EI-295-01
45 x 15 mm

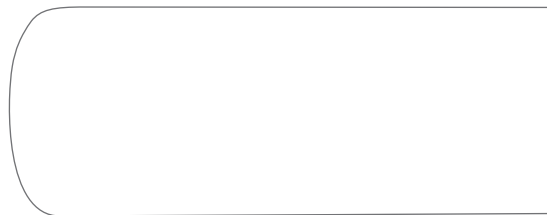

EI-295-02
60 x 23 mm

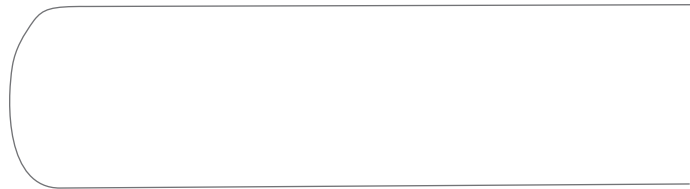

EI-295-02
72 x 20 mm

Sauerbruch Retractor
Overall Length 22.5 cm (8 3/4")

Retractors
Wundhaken, Wundhäkchen
Separadores
Ecarteurs
Divaricatori



Kirsch Retractor
Overall Length 21 cm (8 1/4")

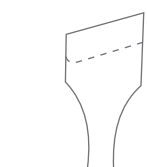

EI-297-01

Left
60 x 11 mm

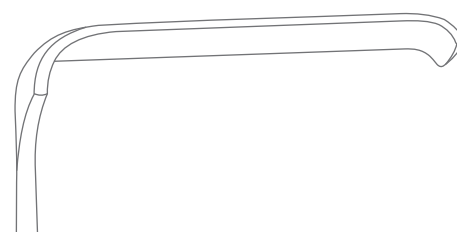

EI-297-02

Right
60 x 11 mm

Retractors
Wundhaken, Wundhäkchen
Separadores
Ecarteurs
Divaricatori

EVA

RETRACTORS



Zenker Retractor

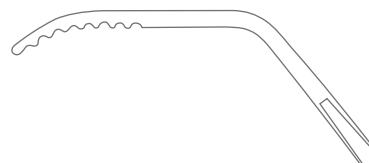

EI-301-01
35 x 8 mm
25 cm (9 3/4")

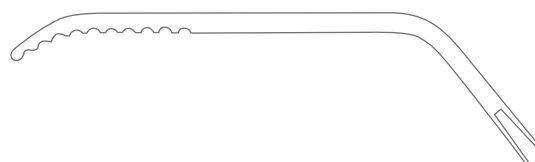

EI-301-02
60 x 12 mm
26.5 cm (10 1/2")



EI-301-03
75 x 12 mm
27.5 cm (10 3/4")

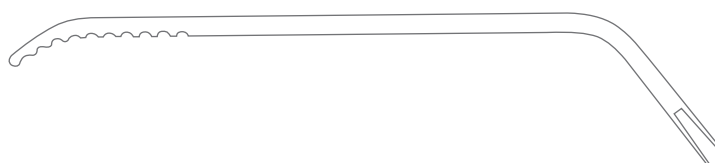

EI-301-04
85 x 20 mm
28.5 cm (11 1/4")

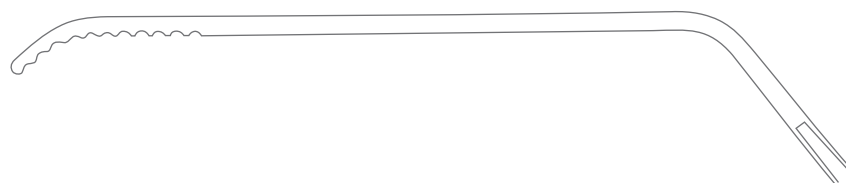

EI-301-05
100 x 25 mm
30.5 cm (12")

Retractors
Wundhaken, Wundhäkchen
Separadores
Ecarteurs
Divaricatori



Cloward Retractor
Overall Length 18.5 cm (7 ¼")

EI-303-18
18 mm

EI-303-20
20 mm

EI-303-23
23 mm



Koenig Retractor
Overall Length 18 cm (7")



EI-305-01
13 x 13 mm



EI-305-02
12 x 16 mm

Retractors
Wundhaken, Wundhäkchen
Separadores
Ecarteurs
Divaricatori

EVA

RETRACTORS



EI-305-17
Cushing-Kocher Retractor
10 x 10 mm
Overall Length 17.5 cm (7")

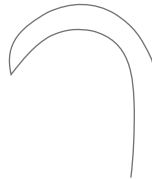

EI-321-01
22 x 12 mm



EI-321-02
24 x 14 mm

Kocher Retractor
Overall Length 21.5 cm (8 1/2")

Retractors
Wundhaken, Wundhäkchen
Separadores
Ecarteurs
Divaricatori



Kocher Retractor
Overall Length 22 cm (8 1/2")

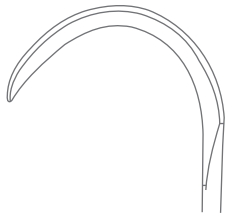

EI-331-01
42 x 10 mm



EI-331-02
42 x 15 mm

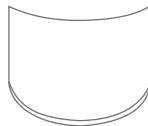

EI-331-03
43 x 20 mm



EI-335-20
Schoenborn Retractor
13 x 6 mm
Overall Length 20 cm (8")



EI-3EI-20
Wound Retractor
Double Ended, 20 x 19 mm
Overall Length 20.5 cm (8")

Retractors
Wundhaken, Wundhäkchen
Separadores
Ecarteurs
Divaricatori

EVA

RETRACTORS



EI-341-23
Dissecting Hook
For Longitudinal
Dissection of Vessels
Overall Length 23.5 cm (9 1/2")



EI-351-21
Durham Retractor
16 x 25 mm
Overall Length 21.5 cm (8 1/2")



Middeldorf Retractor

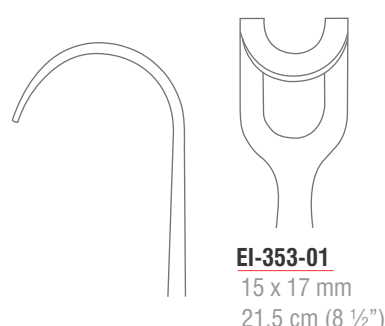

EI-353-01
15 x 17 mm
21.5 cm (8 1/2")

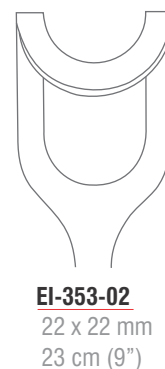

EI-353-02
22 x 22 mm
23 cm (9")

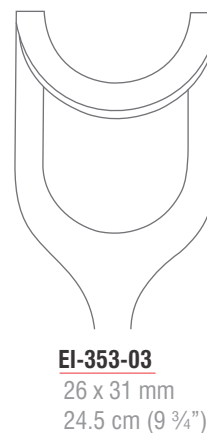

EI-353-03
26 x 31 mm
24.5 cm (9 3/4")

Retractors
Wundhaken, Wundhäkchen
Separadores
Ecarteurs
Divaricatori



Middeldorf Retractor

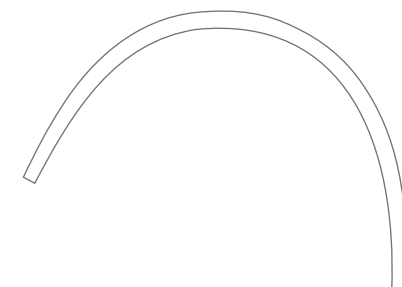

EI-355-01
48 x 45 mm
27 cm (10 3/4")

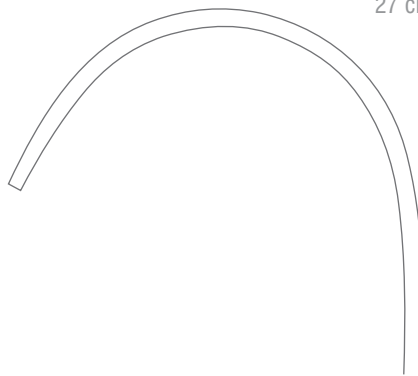

EI-355-02
52 x 50 mm
27 cm (10 3/4")

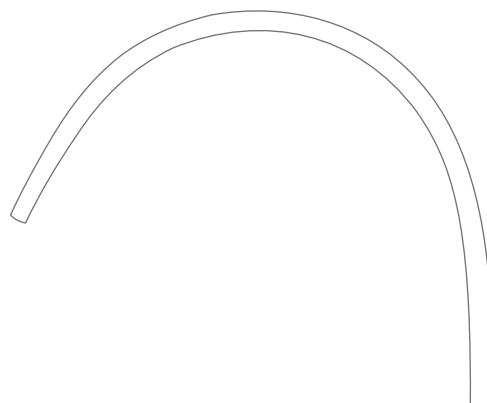

EI-355-03
60 x 70 mm
28 cm (11")

Retractors
Wundhaken, Wundhäkchen
Separadores
Ecarteurs
Divaricatori

EVA

RETRACTORS

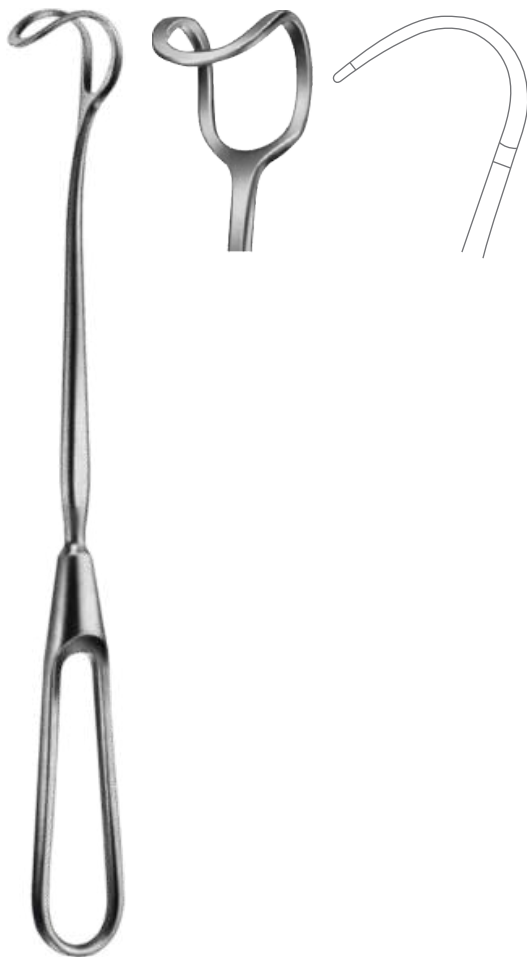

EI-357-22
Greene Retractor
22 x 22 mm
Overall Length 22.5 cm (8 3/4")



EI-361-20
Buchs Retractor
38 x 18 mm
Overall Length 20.5 cm (8")

Retractors
Wundhaken, Wundhäkchen
Separadores
Ecarteurs
Divaricatori



EI-363-21
Kraemer Retractor
66 x 10 mm
Overall Length 21 cm (8 1/4")



EI-365-21
Caspar Retractor
67 x 17 mm
Overall Length 21 cm (8 1/4")



Dockhorn Retractor
Overall Length 21 cm (8 1/4")

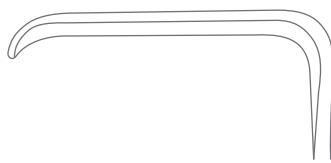

EI-367-01
40 x 12 mm

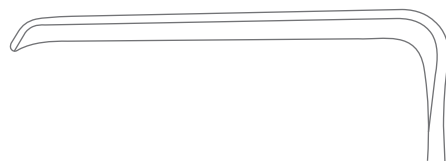

EI-367-02
55 x 14 mm

Retractors
Wundhaken, Wundhäkchen
Separadores
Ecarteurs
Divaricatori

EVA

RETRACTORS



EI-369-18
Cloward Old Style Retractor
18 mm
Overall Length 18 cm (7")



EI-3EI-01
115 x 22 mm

EI-3EI-02
115 x 27 mm

EI-371-25
Martin Retractor
110 x 27 mm
Overall Length 26 cm (10 1/4")

Simon Retractor
Overall Length 28 cm (11")

Retractors
Wundhaken, Wundhäkchen
Separadores
Ecarteurs
Divaricatori



EI-375-18
164 x 30 mm



EI-375-16
160 x 30 mm



EI-375-14
144 x 30 mm



EI-375-13
130 x 30 mm



EI-375-12
124 x 30 mm



EI-375-10
104 x 25 mm

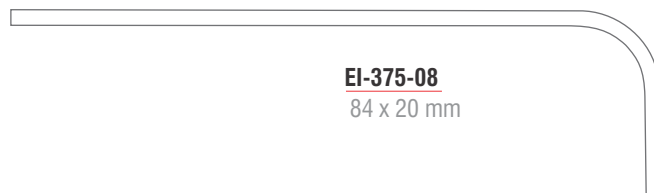

EI-375-08
84 x 20 mm



Brunner Retractor
Overall Length 25.5 cm (10")

Retractors
Wundhaken, Wundhäkchen
Separadores
Ecarteurs
Divaricatori

EVA

RETRACTORS



EI-3EI-18
182 x 30 mm

EI-3EI-16
162 x 30 mm

EI-3EI-14
140 x 25 mm

EI-3EI-12
122 x 30 mm

EI-3EI-10
102 x 20 mm

EI-3EI-08
82 x 20 mm

Brunner Retractor
Overall Length 25.5 cm (10")

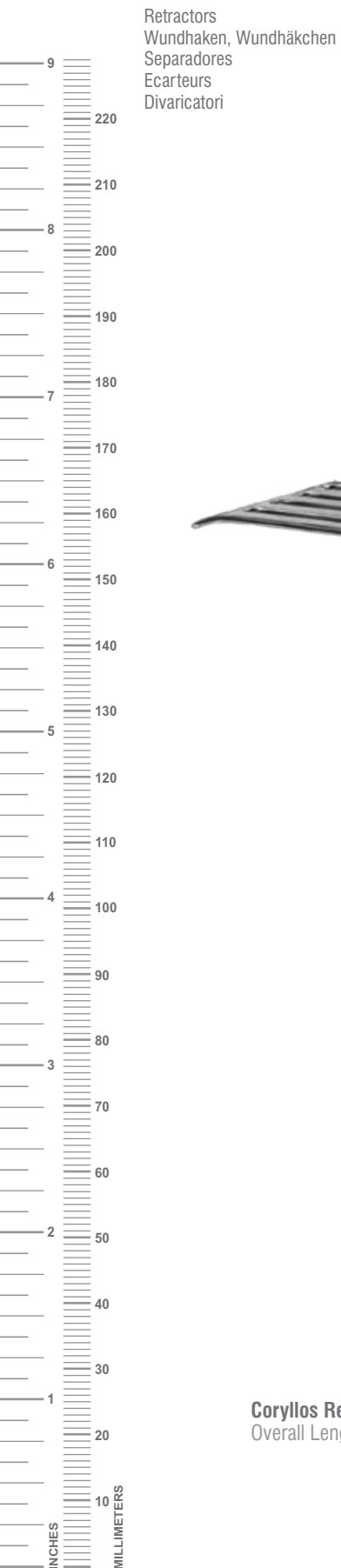

Coryllos Retractor
Overall Length 24 cm (9 1/2")



Retractors
Wundhaken, Wundhäkchen
Separadores
Ecarteurs
Divaricatori

EVA

RETRACTORS



Davidson Scapula Retractor

EI-385-01
80 x 45 mm
19 cm (7 ½")

EI-385-02
80 x 95 mm
18.5 cm (7 ¼")

EI-3EI-25
Sauerbruch Retractor
127 x 38 mm
Overall Length 25.5 cm (10")



EI-400-00
Set of Fig. 1 & Fig. 2

EI-400-01
Fig. 1
28 x 20 mm-36 x 28 mm

EI-400-02
Fig. 2
49 x 38 mm-63 x 49 mm

Richardson-Eastman Retractor

Retractors
Wundhaken, Wundhäkchen
Separadores
Ecarteurs
Divaricatori



Richardson Retractor



EI-403-01
25 x 21 mm
23.5 cm (9 1/4")

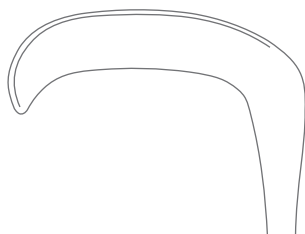

EI-403-02
30 x 29 mm
24 cm (9 1/2")

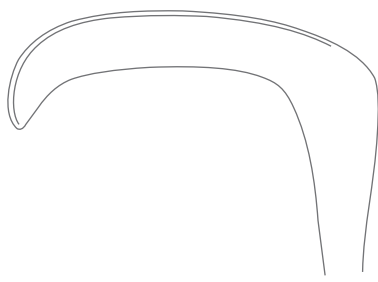

EI-403-03
30 x 29 mm
24 cm (9 1/2")



EI-405-24
Richardson Retractor
48 x 22 mm
Overall Length 24 cm (9 1/2")

Retractors
Wundhaken, Wundhäkchen
Separadores
Ecarteurs
Divaricatori

EVA

RETRACTORS



Kelly Retractor
Overall Length 26 cm (10 1/4")



EI-409-01
50 x 40 mm

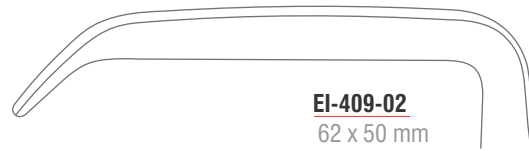

EI-409-02
62 x 50 mm

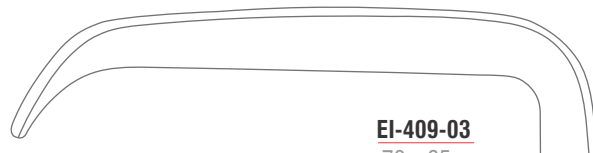

EI-409-03
70 x 65 mm



EI-409-04
90 x 76 mm

Retractors
Wundhaken, Wundhäkchen
Separadores
Ecarteurs
Divaricatori

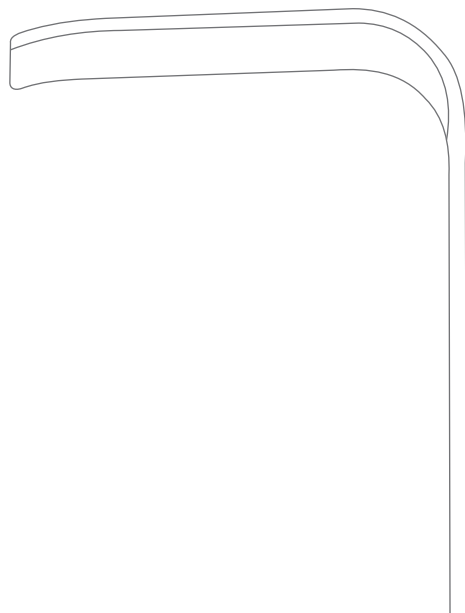

EI-413-21
Tuffier Retractor
58 x 64 mm
Overall Length 21.5 cm (8 ½")



EI-415-01
70 x 40 mm

EI-415-02
70 x 50 mm

EI-415-03
70 x 65 mm

Morris Retractor
Overall Length 24.5 cm (9 ¾")

Retractors
Wundhaken, Wundhäkchen
Separadores
Ecarteurs
Divaricatori

EVA

RETRACTORS



EI-416-01
32 x 51 mm, 38 x 51 mm

EI-416-02
44 x 51 mm, 51 x 51 mm

EI-416-03
64 x 51 mm, 38 x 51 mm

Morris Retractor
Double Ended
Overall Length 21.5 cm (8 1/2")

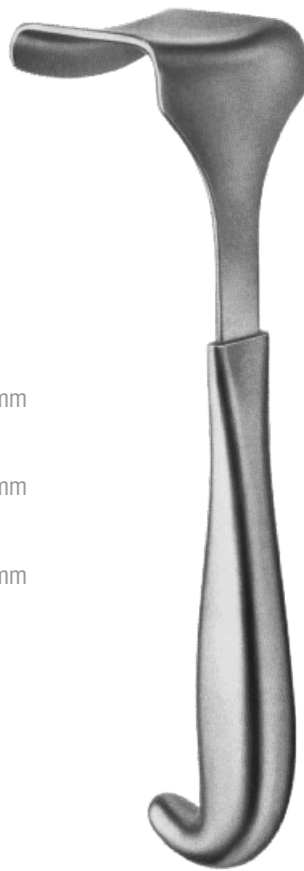

EI-417-20
Tudor-Edwards Retractor
55 x 47 mm
Overall Length 20.5 cm (8")

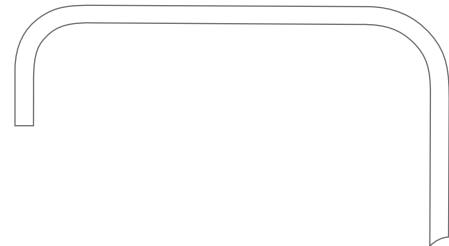

Retractors
Wundhaken, Wundhäkchen
Separadores
Ecarteurs
Divaricatori

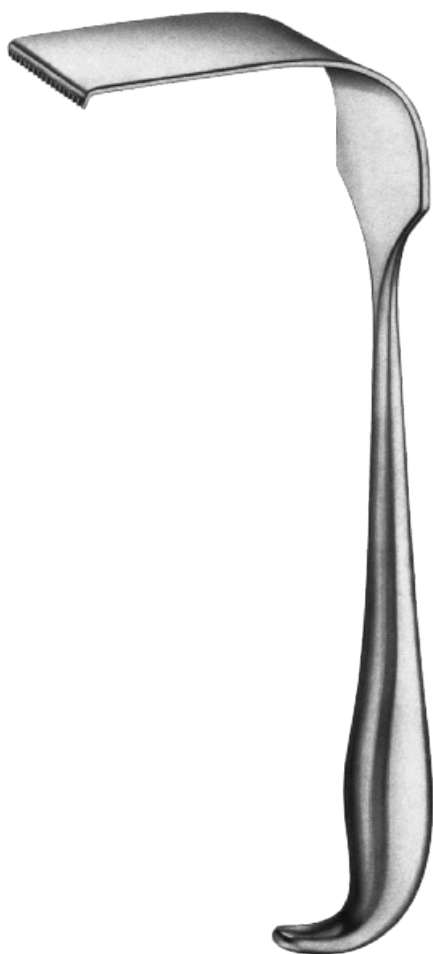

Meyerding Retractor



EI-419-01
52 x 16 mm
23 cm (9")

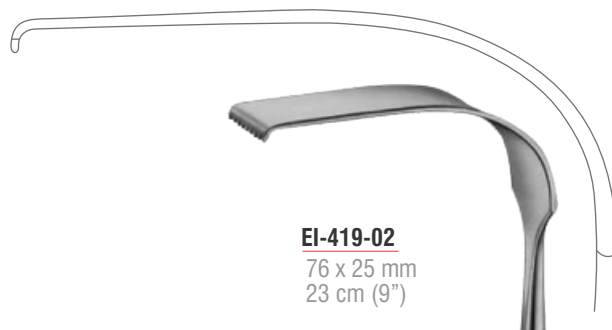

EI-419-02
76 x 25 mm
23 cm (9")

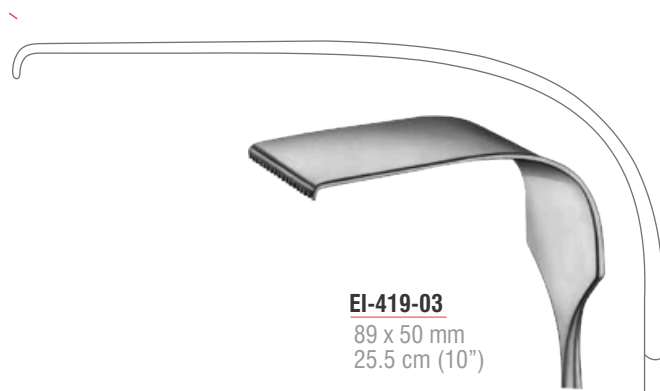

EI-419-03
89 x 50 mm
25.5 cm (10")

Retractors
Wundhaken, Wundhäkchen
Separadores
Ecarteurs
Divaricatori

EVA

RETRACTORS

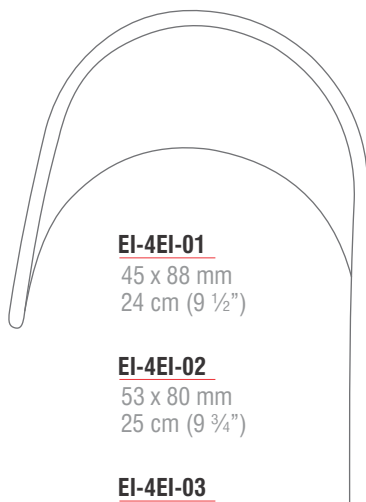

EI-4EI-01
45 x 88 mm
24 cm (9 1/2")

EI-4EI-02
53 x 80 mm
25 cm (9 3/4")

EI-4EI-03
78 x 82 mm
25 cm (9 3/4")

Doyen Retractor

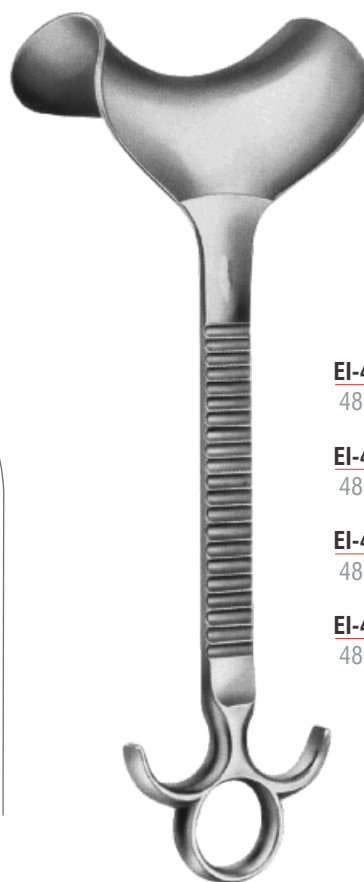

EI-431-01
48 x 90 mm

EI-431-02
48 x 105 mm

EI-431-03
48 x 120 mm

EI-431-04
48 x 135 mm

Doyen Retractor
Overall Length 28 cm (11")



645 Grams

EI-431-10
Chain With Weight
For use with EI-431-01 to EI-431-04
Overall Length 79 cm (31")

Retractors
Wundhaken, Wundhäkchen
Separadores
Ecarteurs
Divaricatori



EI-435-22
Kocher Retractor
73 x 25 mm
Overall Length 24 cm (9 1/2")



Kocher Retractor
Overall Length 25 cm (9 3/4")

EI-4EI-01
80 x 45 mm

EI-4EI-02
80 x 55 mm

EI-4EI-03
80 x 65 mm

Retractors
Wundhaken, Wundhäkchen
Separadores
Ecarteurs
Divaricatori

EVA

RETRACTORS



Doyen-Stille Retractor
Overall Length 26 cm (10 1/4")

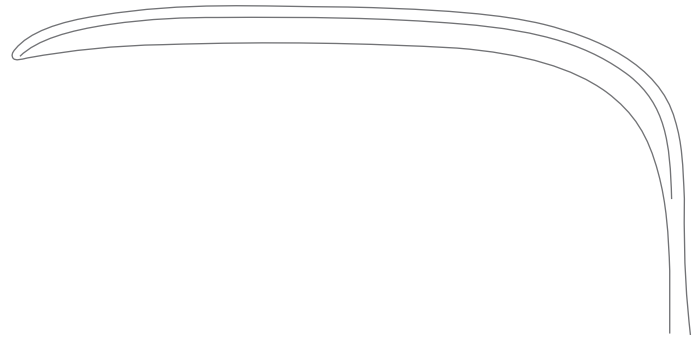

EI-441-01
87 x 28 mm

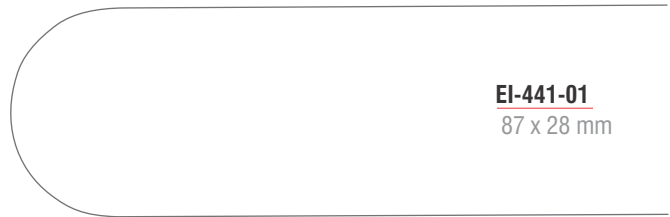

EI-441-02
97 x 31 mm

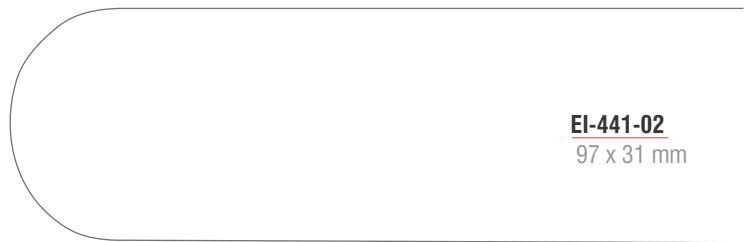

EI-441-03
117 x 52 mm

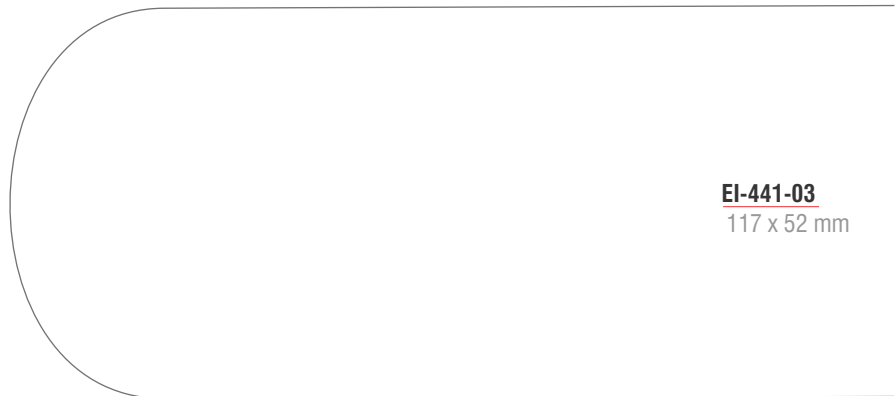

Retractors
Wundhaken, Wundhäkchen
Separadores
Ecarteurs
Divaricatori



Fritsch Retractor

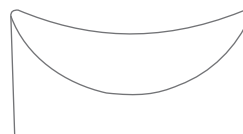

EI-445-01
37 x 31 mm
23.5 cm (9 1/4")



EI-445-02
38 x 40 mm
24 cm (9 1/2")

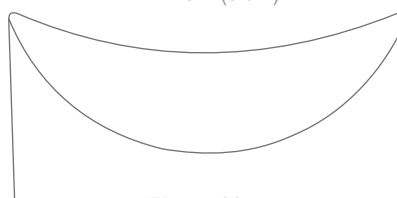

EI-445-03
43 x 51 mm
25 cm (9 3/4")

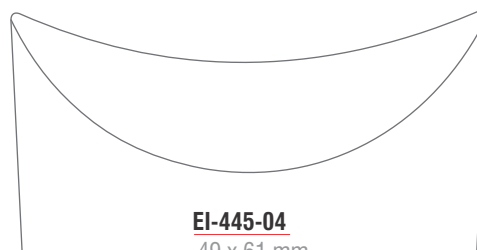

EI-445-04
49 x 61 mm
25 cm (9 3/4")

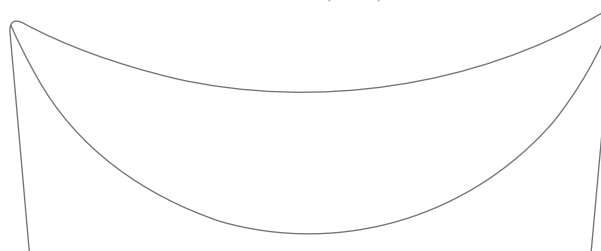

EI-445-05
48 x 75 mm
25.5 cm (10")

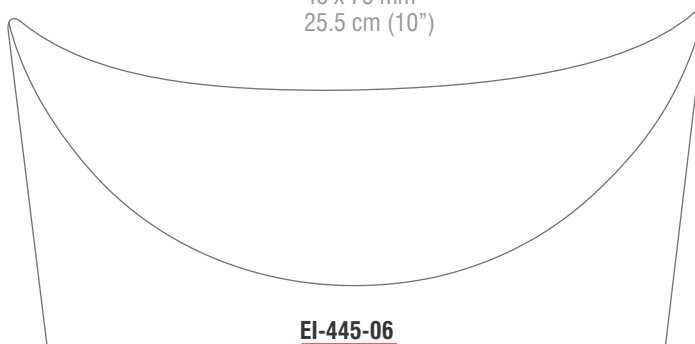

EI-445-06
65 x 85 mm
26.5 cm (10 1/2")

Retractors
Wundhaken, Wundhäkchen
Separadores
Ecarteurs
Divaricatori

EVA

RETRACTORS



Hoesel Retractor
Overall Length 26 cm (10 1/4")

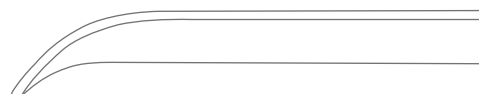

EI-449-01
63 x 21 mm



EI-449-02
83 x 30 mm



EI-449-03
103 x 30 mm



EI-449-04
120 x 30 mm

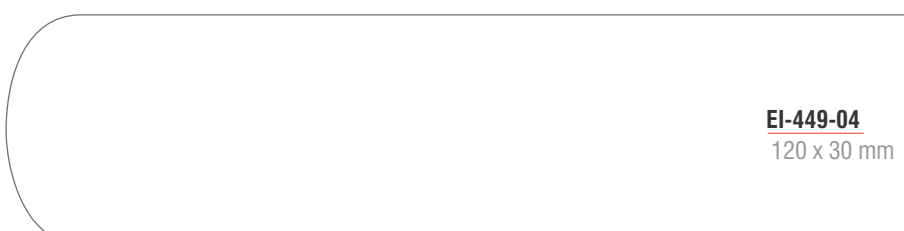

EI-449-05
140 x 30 mm



EI-449-06
140 x 40 mm

Retractors
Wundhaken, Wundhäkchen
Separadores
Ecarteurs
Divaricatori

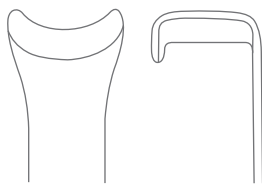

EI-455-01
Fig. 1
16 x 15 mm



EI-455-02
Fig. 2
23 x 13 mm

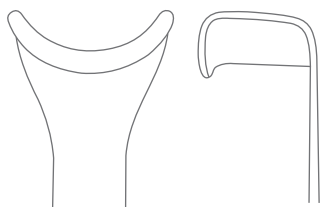

EI-455-03
Fig. 3
24 x 16 mm

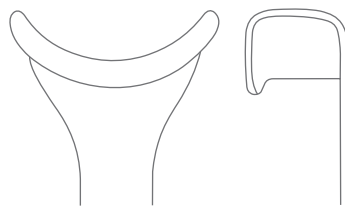

EI-455-04
Fig. 4
27 x 13 mm

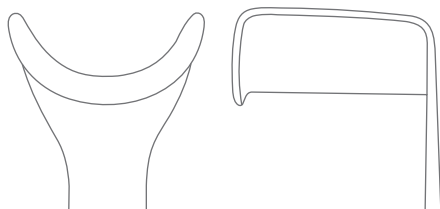

EI-455-05
Fig. 5
27 x 27 mm

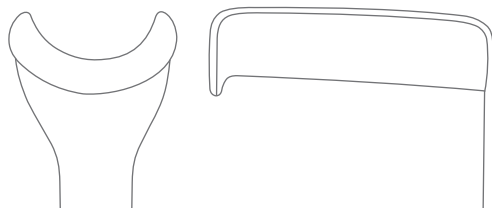

EI-455-06
Fig. 6
25 x 39 mm



Ross Aorta Retractor
Flexible Shaft
Overall Length 25.5 cm (10")



EI-457-06
6.0 mm
EI-457-08
8.0 mm
EI-457-11
11.0 mm
Cleland Valve Leaflet Retractor
Overall Length 26 cm (10 1/4")

Retractors
Wundhaken, Wundhäkchen
Separadores
Ecarteurs
Divaricatori

EVA

RETRACTORS



EI-461-27
Polloson Retractor
Overall Length 25.5 cm (10")

Retractors
Wundhaken, Wundhäkchen
Separadores
Ecarteurs
Divaricatori



EI-463-24
Harrington-Baby Retractor
70 x 24 mm
Overall Length 25.5 cm (10")

Retractors
Wundhaken, Wundhäkchen
Separadores
Ecarteurs
Divaricatori

EVA

RETRACTORS



EI-465-01
137 x 44 mm
31.5 cm (12 1/2")

EI-465-02
137 x 65 mm
33 cm (13")

EI-465-03
175 x 65 mm
33 cm (13")

Harrington Retractor

Retractors
Wundhaken, Wundhäkchen
Separadores
Ecarteurs
Divaricatori



EI-467-44
Foss Gall Bladder Retractor
44 mm
Overall Length 25.5 cm (10")



EI-471-01
Deaver Retractor
Fig. 1, 19 mm
Overall Length 18 cm (7")



EI-471-02
Deaver Retractor
Fig. 2, 22 mm
Overall Length 21.5 cm (8 1/2")



EI-471-03
Deaver Retractor
Fig. 3, 25 mm
Overall Length 25 cm (9 3/4")



EI-471-04
Deaver Retractor
Fig. 4, 25 mm
Overall Length 31 cm (12 1/4")

Retractors
Wundhaken, Wundhäkchen
Separadores
Ecarteurs
Divaricatori

EVA

RETRACTORS



EI-471-05
Deaver Retractor
Fig. 5, 25 mm
Overall Length 33 cm (13")

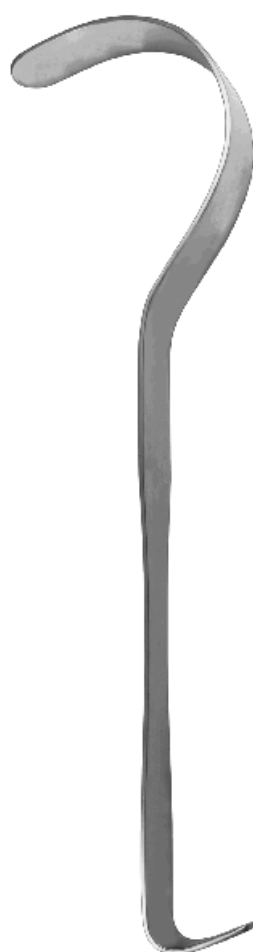

EI-471-06
Deaver Retractor
Fig. 6, 25 mm
Overall Length 36 cm (14 1/4")



EI-471-07
Deaver Retractor
Fig. 7, 25 mm
Overall Length 30 cm (11 3/4")



EI-471-08
Deaver Retractor
Fig. 8, 50 mm
Overall Length 31 cm (12 1/4")

Retractors
Wundhaken, Wundhäkchen
Separadores
Ecarteurs
Divaricatori



EI-471-09
Deaver Retractor
Fig. 9, 75 mm
Overall Length 31.5 cm (12 1/4")



EI-4EI-08
8.0 mm

EI-4EI-10
10.0 mm

EI-4EI-12
12.0 mm

Deaver Baby Retractor
Overall Length 17 cm (12 1/4")

Retractors
Wundhaken, Wundhäkchen
Separadores
Ecarteurs
Divaricatori

EVA

RETRACTORS



Deaver Retractor
With Hollow Handle
Overall Length 31.5 cm (12 ½")



EI-475-04
Fig. 4, 25 mm



EI-475-07
Fig. 7, 38 mm

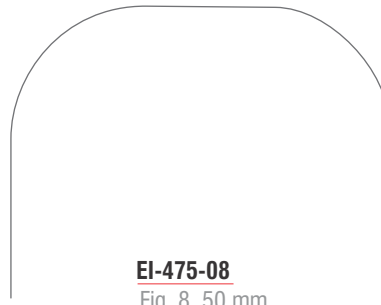

EI-475-08
Fig. 8, 50 mm



EI-475-10
Fig. 10, 100 mm

Retractors
Wundhaken, Wundhäkchen
Separadores
Ecarteurs
Divaricatori



Leriche Retractor

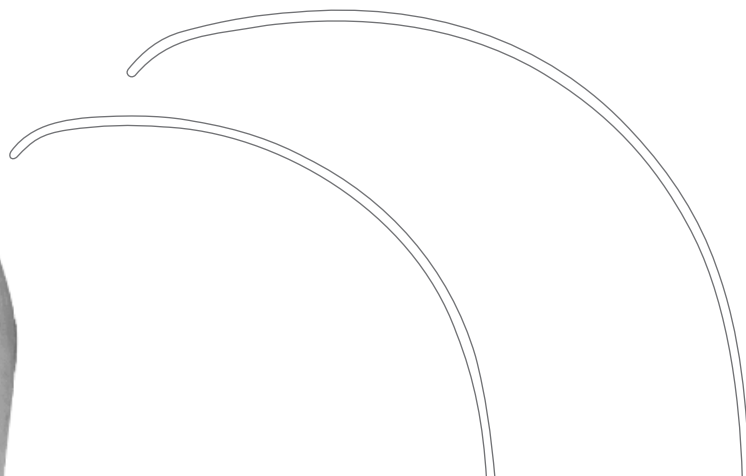

EI-479-01
45 mm
25.5 cm (10")

EI-479-02
60 mm
27.5 cm (10 3/4")

Retractors
Wundhaken, Wundhäkchen
Separadores
Ecarteurs
Divaricatori

EVA

RETRACTORS



EI-479-03
Kummel Retractor
46 mm
Overall Length 28.5 cm (11 1/4")



EI-481-30
Koerte Retractor
46 mm
Overall Length 30 cm (11 3/4")

Retractors
Wundhaken, Wundhäkchen
Separadores
Ecarteurs
Divaricatori



- EI-483-01**
25 x 44 mm
- EI-483-02**
28 x 73 mm
- EI-483-03**
28 x 83 mm

Heaney Retractor
Overall Length 26.5 cm (10 1/2")



- EI-485-01**
Right
45 x 48 mm
- EI-485-02**
Right, Serrated
45 x 48 mm

Cooley Mitral Valve Retractor
Overall Length 25 cm (9 3/4")



- EI-485-03**
Left
25 x 46 mm

Cooley Mitral Valve Retractor
Overall Length 27 cm (10 3/4")



- EI-485-04**
Right
45 x 30 mm
- EI-485-05**
Right
45 x 35 mm

Cooley Mitral Valve Retractor
Overall Length 25 cm (9 3/4")

Retractors
Wundhaken, Wundhäkchen
Separadores
Ecarteurs
Divaricatori

EVA

RETRACTORS



EI-4EI-01
Right Small, 22 mm
18.5 cm (7 1/4")

EI-4EI-02
Right Medium, 34 mm
19 cm (7 1/2")

EI-4EI-03
Right Large, 47 mm
19 cm (7 1/2")

Cooley Mitral Valve Retractor

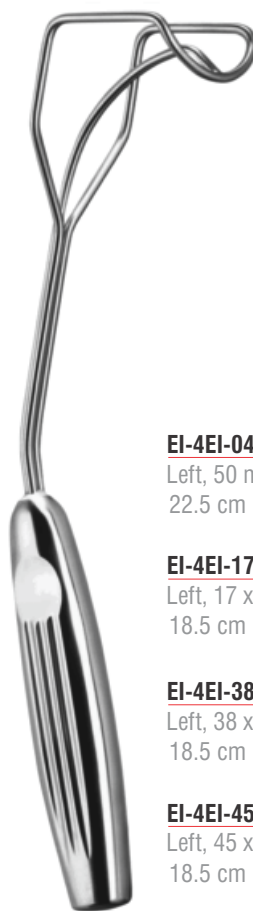

EI-4EI-04
Left, 50 mm
22.5 cm (8 3/4")

EI-4EI-17
Left, 17 x 19 mm
18.5 cm (7 1/4")

EI-4EI-38
Left, 38 x 19 mm
18.5 cm (7 1/4")

EI-4EI-45
Left, 45 x 22 mm
18.5 cm (7 1/4")

Cooley Mitral Valve Retractor



Borowski Aortic Valve Retractor
Overall Length 27 cm (10 3/4")

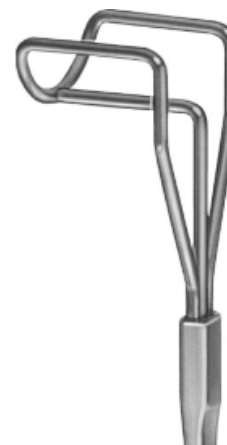

EI-488-01
17 x 21 mm

EI-488-02
16 x 23 mm

Retractors
Wundhaken, Wundhäkchen
Separadores
Ecarteurs
Divaricatori



Mikulicz Liver Retractor
Overall Length 25 cm (9 3/4")

Retractors
Wundhaken, Wundhäkchen
Separadores
Ecarteurs
Divaricatori

EVA

RETRACTORS

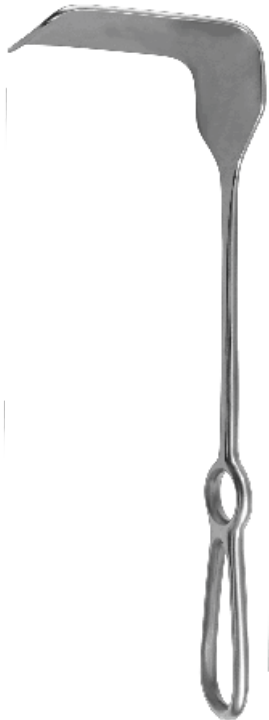

EI-491-26
Mikulicz Retractor
90 x 55 mm
Overall Length 26 cm (10 1/4")



EI-495-01
205 x 38



EI-495-02
205 x 57

Kelly Retractor
Overall Length 27.5 cm (10 3/4")

Pelvis Retractors
Pelvishaken
Separadores para pelvis
Ecarteurs pour pelvis
Divaricatori per pelvis



St. Marks Pelvis Retractor

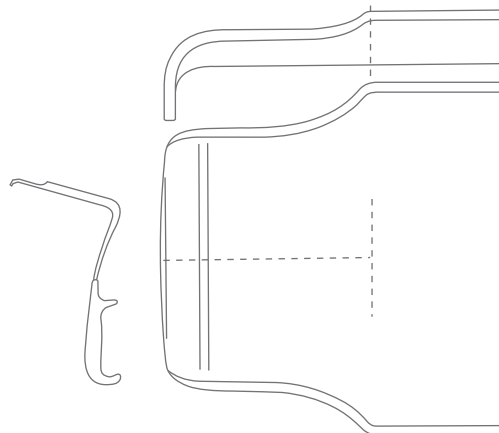

EI-501-01
142 x 60 mm - 35 x 45 mm
29 cm (11 1/2")

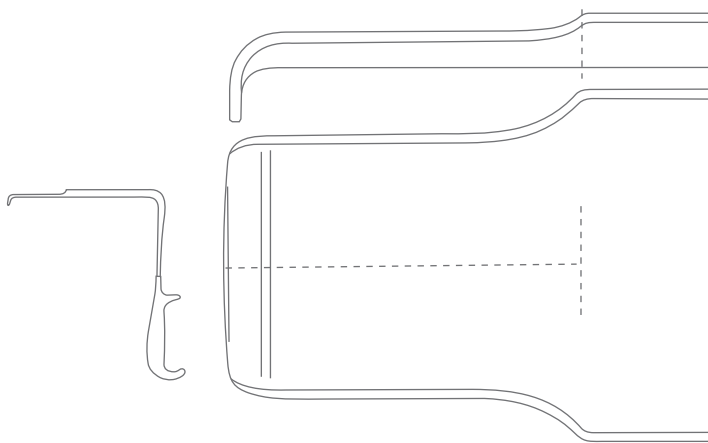

EI-501-02
193 x 60 mm - 60 x 45 mm
29 cm (11 1/2")

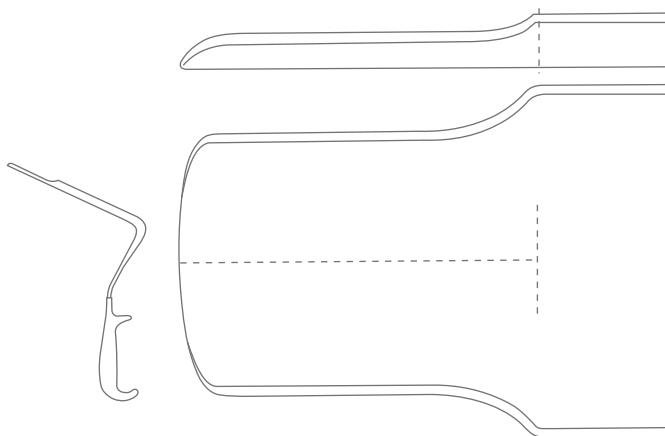

EI-501-03
195 x 60 mm - 60 x 45 mm
33 cm (13")

Abdominal Spatulas
Bauchspatel
Espátulas abdominales
Spatules abdominales
Spatole addominali

EVA

RETRACTORS



EI-511-28
Kummel Abdominal Spatula
45 mm
Overall Length 31 cm (12 1/4")



Kader Abdominal Spatula
Overall Length 28 cm (11")

EI-515-20
20 mm

EI-515-30
30 mm

EI-515-40
40 mm



EI-520-30
30 mm

EI-520-40
40 mm

EI-520-50
50 mm

EI-520-60
60 mm

EI-520-70
70 mm

Abdominal Spatula
Overall Length 41 cm (16")

Abdominal Spatulas
Bauchspatel
Espátulas abdominales
Spatules abdominales
Spatole addominali

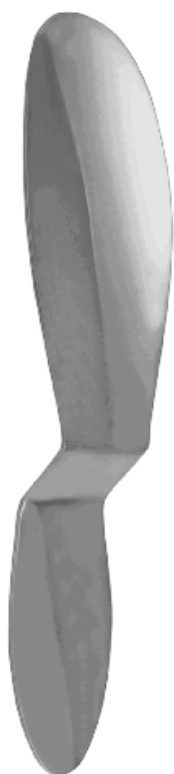

EI-5EI-28
Reverdin Abdominal Spatula
63 x 45 mm
Overall Length 28.5 cm (11 1/4")



Abdominal Spatula
Overall Length 33 cm (13")

EI-530-20
20 mm

EI-530-25
25 mm

EI-530-30
30 mm

EI-530-40
40 mm

EI-530-50
50 mm



EI-5EI-20
Tuffier Abdominal Spatula
Tapered, 16 x 25 mm
Overall Length 20 cm (8")



Haberer Abdominal Spatula
Tapered

EI-536-01
25 x 30 mm
28 cm (11")

EI-536-02
37 x 45 mm
30 cm (11 3/4")

EI-536-03
40 x 50 mm
30.5 cm (12")

Abdominal Spatulas
Bauchspatel
Espátulas abdominales
Spatules abdominales
Spatole addominali

EVA

RETRACTORS



EI-540-06
6.5 mm

EI-540-09
9.5 mm

EI-540-13
13 mm

EI-540-16
16 mm

EI-540-19
19 mm

EI-540-25
25 mm

Martin Abdominal Spatula
Malleable, Very Soft
Overall Length 20 cm (8")



EI-549-15
Kilner Cheek Retractor
Overall Length 15 cm (6")

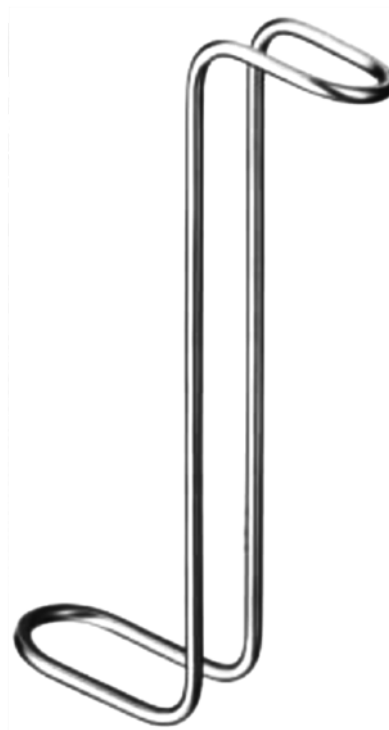

EI-551-01
Collin-Hartmann Retractor
Overall Length 15 cm (6")



EI-553-01
12 cm (4 3/4")

EI-553-01
13 cm (5")

EI-553-01
13.5 cm (5 1/4")

Sternberg Retractor

Retractors
Wundhaken, Wundhäkchen
Separadores
Ecarteurs
Divaricatori



EI-555-02
Hasson "S Shaped" Retractor
Pair
Blade Width 10 mm
Overall Length 16 cm (6 1/4")

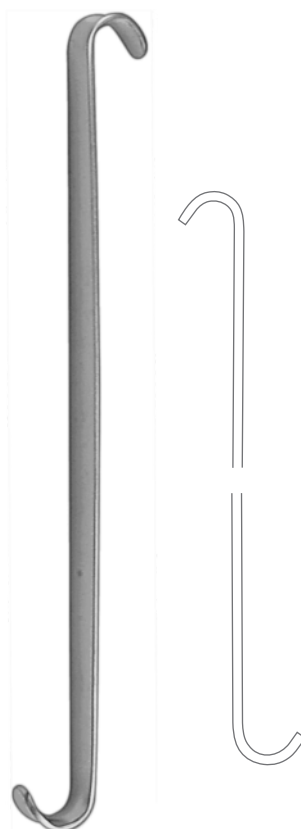

EI-557-14
Roux-Mini Retractor
6 x 7 mm - 7 x 8 mm
Overall Length 14.5 cm (5 3/4")

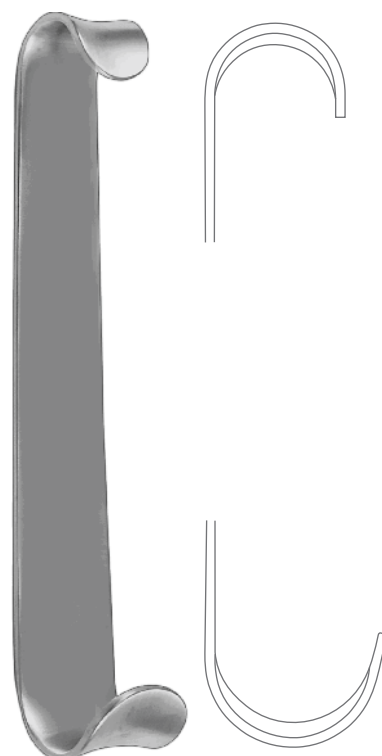

EI-559-12
Roux-Baby Retractor
17 x 17 mm - 24 x 21 mm
Overall Length 12.5 cm (5")

Retractors
Wundhaken, Wundhäkchen
Separadores
Ecarteurs
Divaricatori

EVA

RETRACTORS

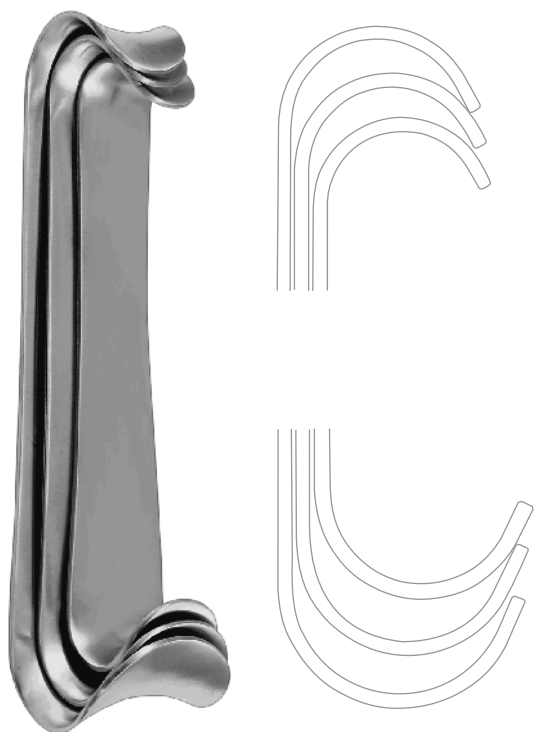

EI-561-00
Roux Retractor
Set (Fig. 1,2,3)



EI-561-01
Fig. 1
14 cm (5 1/2")

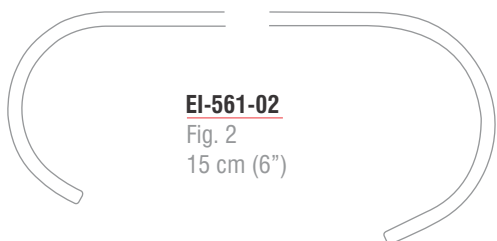

EI-561-02
Fig. 2
15 cm (6")



EI-561-03
Fig. 2
17 cm (6 3/4")



EI-563-00
Collin Retractor Set
Fig. 1
17 x 14 mm - 28 x 16 mm
Fig. 2
21 x 14 mm - 32 x 16 mm
Overall Length 15 cm (6")

Retractors
Wundhaken, Wundhäkchen
Separadores
Ecarteurs
Divaricatori

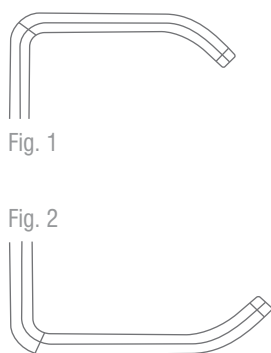

EI-565-00
Farabeuf Retractor Set
Fig. 1
26 x 10 mm - 30 x 13 mm
Fig. 2
30 x 10 mm - 34 x 13 mm
Overall Length 12 cm (4 ¾")

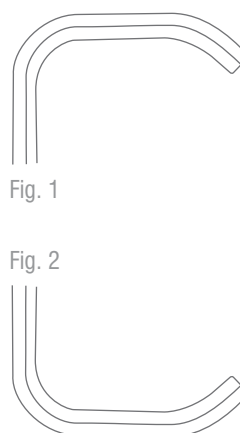
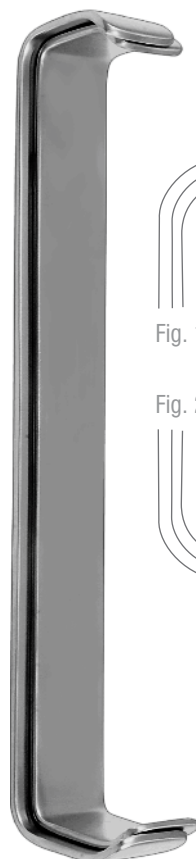

EI-567-00
Farabeuf Retractor Set
Fig. 1
23 x 16 mm - 26 x 16 mm
Fig. 2
27 x 16 mm - 30 x 16 mm
Overall Length 15 cm (6")

Retractors
Wundhaken, Wundhäkchen
Separadores
Ecarteurs
Divaricatori

EVA

RETRACTORS



EI-571-01

Fig. 1

19 x 15 mm - 19 x 15 mm,
22 x 15 mm - 22 x 15 mm
13.5 cm (5 1/4")

EI-571-02

Fig. 1

26 x 25 mm - 27 x 25 mm,
29 x 25 mm - 27 x 25 mm
17.5 cm (7")

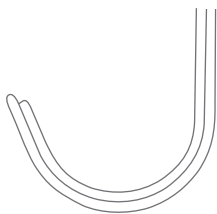

Parker Retractor Set

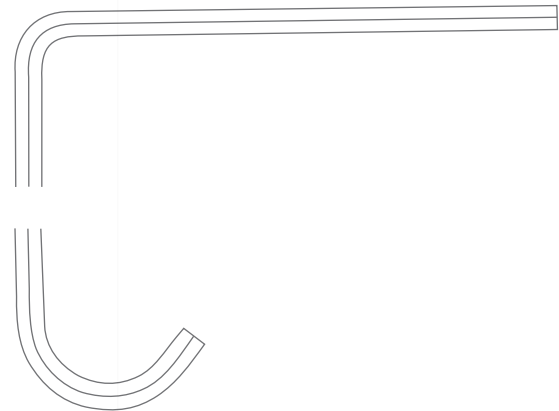

EI-5EI-16

Parker-Mott Retractor Set

21 x 24 mm - 68 x 24 mm, 25 x 24 mm - 72 x 24 mm
Overall Length 16 cm (6 1/4")

Retractors
Wundhaken, Wundhäkchen
Separadores
Ecarteurs
Divaricatori

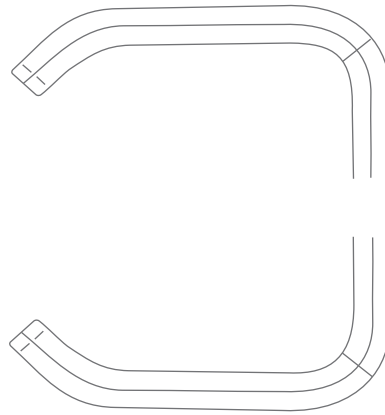

EI-5EI-20

Mathieu Retractor Set

Fig. 1

42 x 13 mm - 42 x 26 mm

Fig. 2

47 x 13 mm - 46 x 26 mm

Overall Length 20 cm (8")

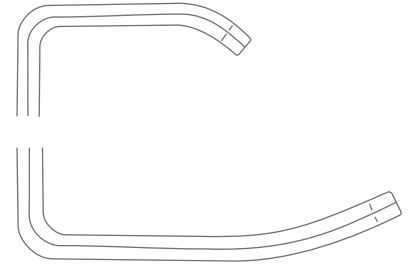

EI-579-21

Parker-Langenbeck (US Army) Retractor

Fig. 1

21 x 15 mm - 40 x 15 mm

Fig. 2

25 x 15 mm - 45 x 15 mm

Overall Length 21.5 cm (8 1/2")

Retractors
Wundhaken, Wundhäkchen
Separadores
Ecarteurs
Divaricatori

EVA

RETRACTORS



EI-581-16
Hajek Retractor
30 x 18 mm - 25 x 10 mm
Overall Length 16.5 cm (6 1/2")



EI-583-01
30 x 13 mm
35 x 19 mm

EI-583-02
30 x 25 mm
35 x 32 mm

Lane Retractor
Overall Length 23 cm (9")



EI-591-17
Czerny Retractor
38 x 22 mm - 38 x 22 mm
Overall Length 17.5 cm (7")

Retractors
Wundhaken, Wundhäkchen
Separadores
Ecarteurs
Divaricatori



EI-593-19
Goelet Retractor
40 x 40 mm - 30 x 30 mm
Overall Length 19 cm (7 ½")



Canny-Ryall Retractor

EI-595-01
16 mm
19 cm (7 ½")

EI-595-02
20 mm
19 cm (7 ½")

EI-595-03
25 mm
20 cm (8")



EI-597-11
Crile Retractor
3 x 11 mm - 6 x 20 mm
Overall Length 11.5 cm (4 ½")

Wound Spreaders, Self-Retaining
Wundspreizer
Separadores autoestáticos
Ecarteurs autostatiques
Divaricatori autostatici

EVA

RETRACTORS

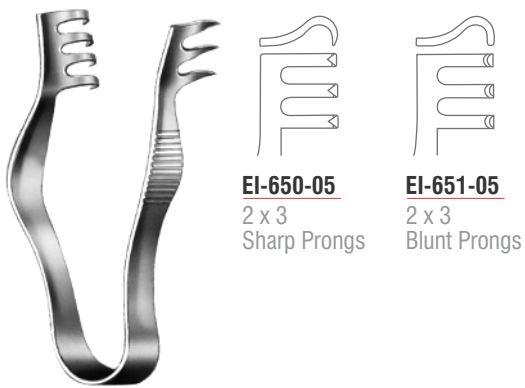

EI-650-05
2 x 3
Sharp Prongs

EI-651-05
2 x 3
Blunt Prongs

Finsen Wound Spreader
Overall Length 5 cm (2")

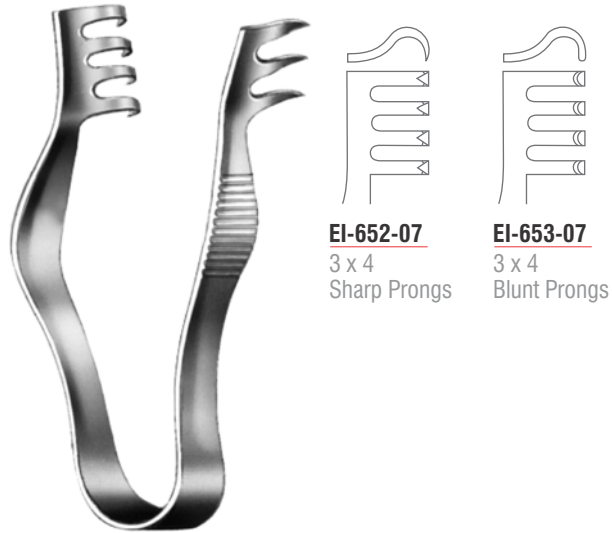

EI-652-07
3 x 4
Sharp Prongs

EI-653-07
3 x 4
Blunt Prongs

Finsen Wound Spreader
Overall Length 7 cm (2 3/4")

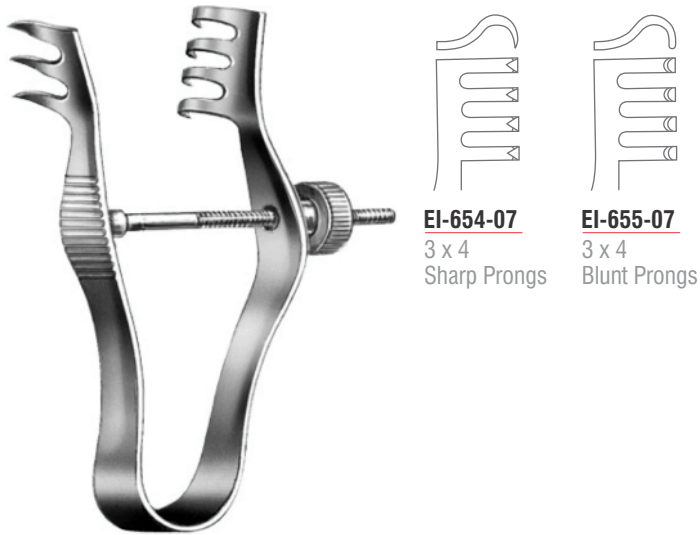

EI-654-07
3 x 4
Sharp Prongs

EI-655-07
3 x 4
Blunt Prongs

Finsen-Martin Wound Spreader
With Adjustment Screw
Overall Length 7 cm (2 3/4")

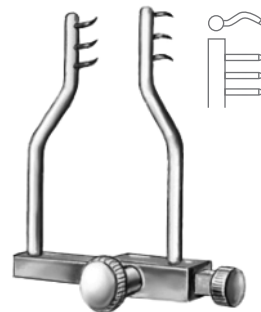

EI-658-04
Logan Wound Spreader
3 x 3 Sharp - With Adjustment Screw
Overall Length 4 cm (1 1/2")

Wound Spreaders, Self-Retaining
Wundspreizer
Separadores autoestáticos
Ecarteurs autostatiques
Divaricatori autostatici



EI-661-30
Bose Fat Spreader for Coronary Surgery
Overall Length 3 cm (1 1/4")



EI-663-40
4 cm (1 1/2")

EI-663-55
5.5 cm (2 1/4")

Fat Spreader for Coronary Surgery



Spring Wire Retractor

EI-665-03
3 Toothed Blades
8.5 cm (3 1/2")

EI-665-04
4 Toothed Blades
11.5 cm (4 1/2")

Wound Spreaders, Self-Retaining
Wundspreizer
Separadores autoestáticos
Ecarteurs autostatiques
Divaricatori autostatici

EVA

RETRACTORS



EI-666-06
Buckley Wound Spreader
3 x 3 Sharp Prongs
Overall Length 6 cm (2 1/4")



Alm Wound Spreader



EI-668-07
4 x 4 Sharp Prongs
7 cm (2 3/4")



EI-668-10
4 x 4 Sharp Prongs
10 cm (4")



EI-669-07
4 x 4 Blunt Prongs
7 cm (2 3/4")



EI-669-10
4 x 4 Blunt Prongs
10 cm (4")



EI-672-10
Allport Wound Spreader
4 x 4 Sharp Prongs
Overall Length 9.5 cm (3 3/4")



EI-674-10
4 x 4 Sharp Prongs

EI-674-10
4 x 4 Blunt Prongs

Wound Spreader
Overall Length 10 cm (4")

Wound Spreaders, Self-Retaining
Wundspreizer
Separadores autoestáticos
Ecarteurs autostatiques
Divaricatori autostatici



EI-6EI-10
Jansen Self Retaining Retractor
3 x 3 Blunt Prongs
With Adjustment Screw
Overall Length 10 cm (4")

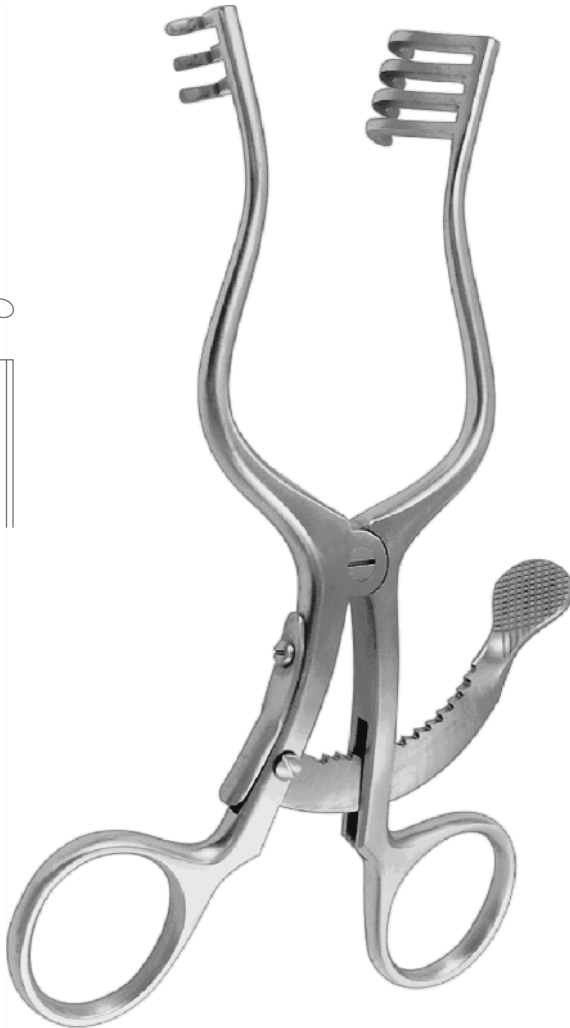
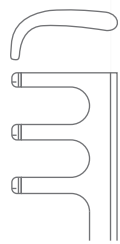

Scalp-Contour Self Retaining Retractor
Overall Length 13.5 cm (5 1/4")

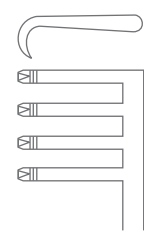

EI-680-13
3 x 4 Sharp Prongs

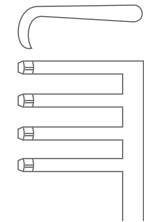

EI-681-13
3 x 4 Blunt Prongs

Wound Spreaders, Self-Retaining
Wundspreizer
Separadores autoestáticos
Ecarteurs autostatiques
Divaricatori autostatici

EVA

RETRACTORS



EI-684-20
7 x 7 Sharp Prongs
EI-685-20
7 x 7 Blunt Prongs

Miskimon Self Retaining Retractor
Overall Length 20.5 cm (8")



Anderson-Adson Self Retaining Retractor
Overall Length 20 cm (8")

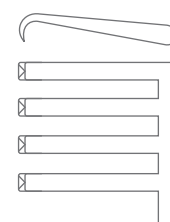

EI-686-20
4 x 4 Sharp Prongs

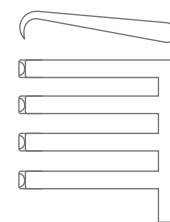

EI-6EI-20
4 x 4 Blunt Prongs

Wound Spreaders, Self-Retaining
Wundspreizer
Separadores autoestáticos
Ecarteurs autostatiques
Divaricatori autostatici



EI-689-21
Traverse Self Retaining Retractor
4 x 5 Blunt Prongs
Overall Length 21.5 cm (8 1/2")



EI-691-22
Norfolk-Norwich Self Retaining Retractor
4 x 5 Blunt Prongs
Overall Length 22 cm (8 3/4")

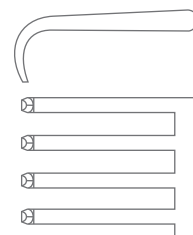

Wound Spreaders, Self-Retaining
Wundspreizer
Separadores autoestáticos
Ecarteurs autostatiques
Divaricatori autostatici

EVA

RETRACTORS

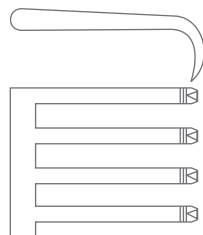

EI-696-20
3 x 4 Sharp Prongs

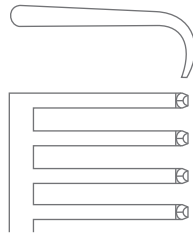

EI-697-20
3 x 4 Blunt Prongs

Weitlaner Self Retaining Retractor
Overall Length 20 cm (8")

Wound Spreaders, Self-Retaining
Wundspreizer
Separadores autoestáticos
Ecarteurs autostatiques
Divaricatori autostatici



Adson Self Retaining Retractor

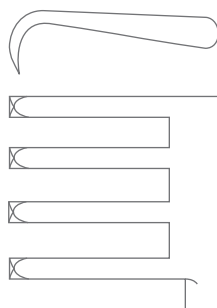

EI-700-26
3 x 4 Sharp Prongs
26 cm (10 1/4")

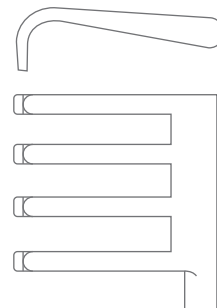

EI-701-26
3 x 4 Blunt Prongs
26 cm (10 1/4")

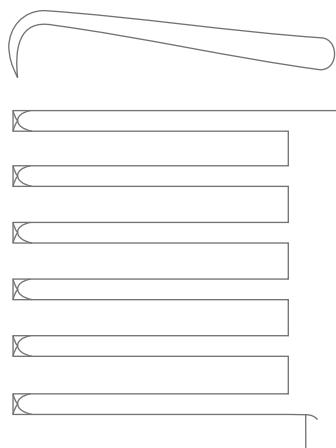

EI-702-26
6 x 6 Sharp Prongs
29 cm (11 1/2")

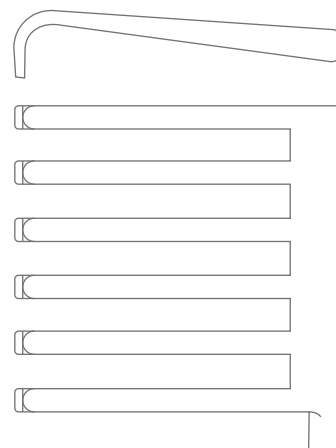

EI-703-26
6 x 6 Blunt Prongs
29 cm (11 1/2")

Wound Spreaders, Self-Retaining
Wundspreizer
Separadores autoestáticos
Ecarteurs autostatiques
Divaricatori autostatici

EVA

RETRACTORS

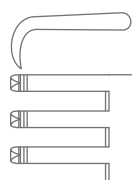

EI-710-11
2 x 3 Sharp Prongs

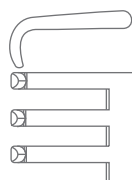

EI-711-11
2 x 3 Blunt Prongs

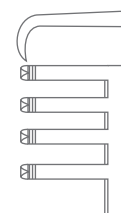

EI-712-13
3 x 4 Sharp Prongs
13.5 cm (5 1/4")

EI-712-16
3 x 4 Sharp Prongs
16 cm (6 1/4")

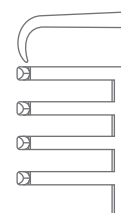

EI-713-13
3 x 4 Blunt Prongs
13.5 cm (5 1/4")

EI-713-16
3 x 4 Blunt Prongs
16 cm (6 1/4")

Weitlaner Self Retaining Retractor
Overall Length 11 cm (4 1/4")

Weitlaner Self Retaining Retractor

Wound Spreaders, Self-Retaining
Wundspreizer
Separadores autoestáticos
Ecarteurs autostatiques
Divaricatori autostatici



Weitlaner-Wullstein Self Retaining Retractor
Overall Length 13 cm (5")

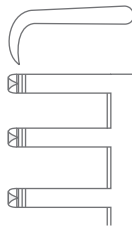

EI-716-13
3 x 3 Sharp Prongs

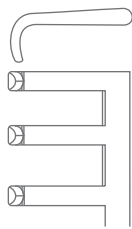

EI-717-13
3 x 3 Blunt Prongs

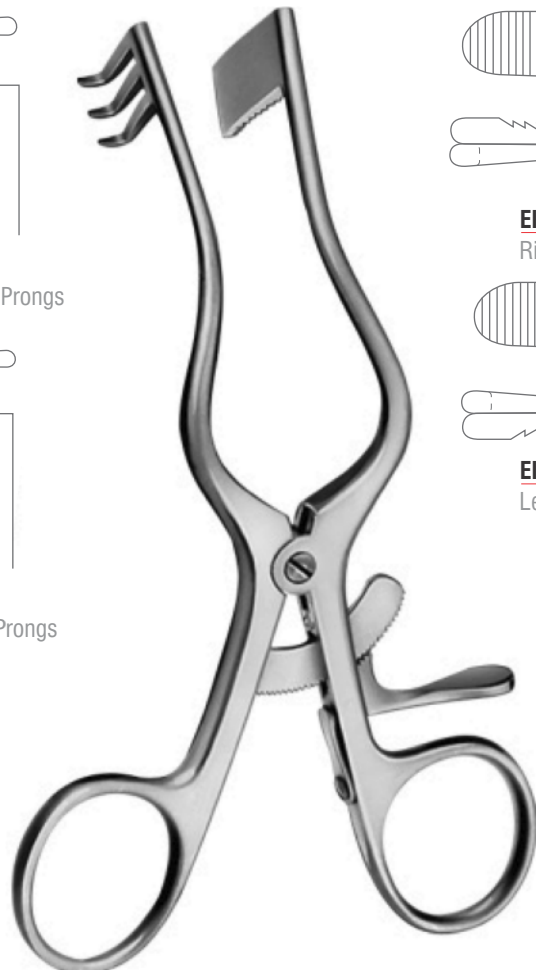

Perkins Self Retaining Retractor
Overall Length 13 cm (5")

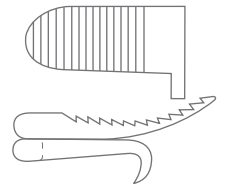

EI-721-01
Right

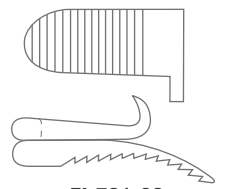

EI-721-02
Left

Wound Spreaders, Self-Retaining
Wundspreizer
Separadores autoestáticos
Ecarteurs autostatiques
Divaricatori autostatici

EVA

RETRACTORS



EI-725-14
Jefferson Self Retaining Retractor
2 x 3 Blunt Prongs
Overall Length 14 cm (5 ½")



EI-726-16

EI-726-16 WC
With Central Blade

Mayo-Adams Self Retaining Retractor
2 x 2 Blunt Prongs
Overall Length 16.5 cm (6 ½")

Wound Spreaders, Self-Retaining
Wundspreizer
Separadores autoestáticos
Ecarteurs autostatiques
Divaricatori autostatici



EI-728-14
Mollison Self Retaining Retractor
2 x 2 Sharp Prongs
Overall Length 14 cm (5 1/2")



EI-730-15
Mollison Self Retaining Retractor
4 x 4 Blunt Prongs
Overall Length 15.5 cm (6")

Wound Spreaders, Self-Retaining
Wundspreizer
Separadores autoestáticos
Ecarteurs autostatiques
Divaricatori autostatici

EVA

RETRACTORS

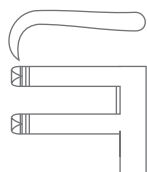

EI-732-13
2 x 2 Sharp Prongs

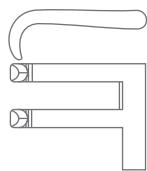

EI-733-13
2 x 2 Blunt Prongs

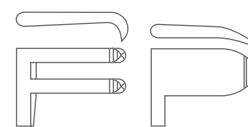

EI-735-01
Left



EI-735-02
Right

Plester Self Retaining Retractor
Overall Length 13 cm (5")

Plester Self Retaining Retractor
Overall Length 10.5 cm (4")

Wound Spreaders, Self-Retaining
Wundspreizer
Separadores autoestáticos
Ecarteurs autostatiques
Divaricatori autostatici



EI-7EI-13
Milligan Self Retaining Retractor
3 x 3 Blunt Prongs
Overall Length 13.5 cm (5 1/4")

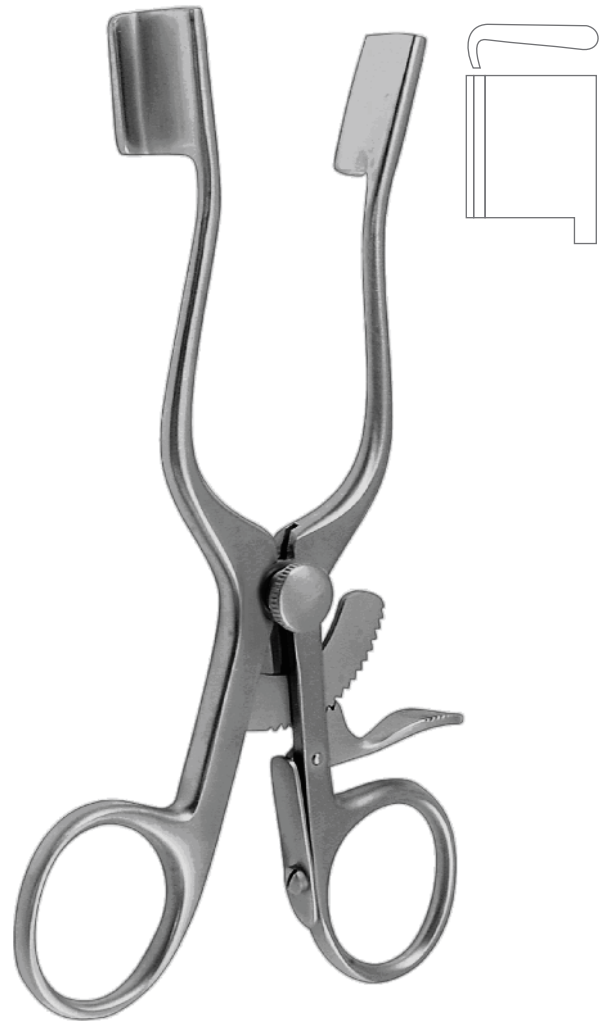

EI-739-13
Weitlaner-Baby Self Retaining Retractor
Blunt
Overall Length 13.5 cm (5 1/4")

Wound Spreaders, Self-Retaining
Wundspreizer
Separadores autoestáticos
Ecarteurs autostatiques
Divaricatori autostatici

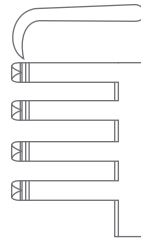

EI-742-13
3 x 4 Sharp Prongs
14 cm (5 1/2")

EI-742-16
3 x 4 Sharp Prongs
16.5 cm (6 1/2")

EI-742-21
3 x 4 Sharp Prongs
21 cm (8 1/4")

EI-742-13
3 x 4 Sharp Prongs
24.5 cm (9 3/4")

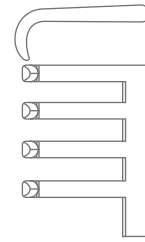

EI-743-13
3 x 4 Blunt Prongs
14 cm (5 1/2")

EI-743-16
3 x 4 Blunt Prongs
16.5 cm (6 1/2")

EI-743-21
3 x 4 Blunt Prongs
21 cm (8 1/4")

EI-743-13
3 x 4 Blunt Prongs
24.5 cm (9 3/4")

Adson Self Retaining Retractor

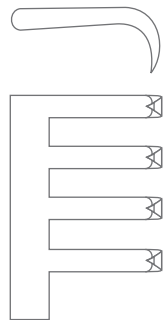

EI-750-32
4 x 4 Sharp Prongs
32 cm (12 1/2")

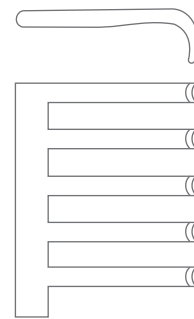

EI-753-33
4 x 5 Blunt Prongs
33 cm (13")

Beckmann Self Retaining Retractor

Adson Self Retaining Retractor

EVA

RETRACTORS

Wound Spreaders, Self-Retaining
Wundspreizer
Separadores autoestáticos
Ecarteurs autostatiques
Divaricatori autostatici



EI-758-28
Harvey-Jackson Self Retaining Retractor
3 x 3 Sharp Prongs
Overall Length 28 cm (11")

EI-760-30
Beckmann-Adson Self Retaining Retractor
4 x 4 Short Sharp Prongs
Overall Length 30.5 cm (12")

Wound Spreaders, Self-Retaining
Wundspreizer
Separadores autoestáticos
Ecarteurs autostatiques
Divaricatori autostatici

EVA

RETRACTORS

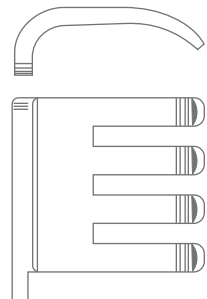

EI-761-30
4 x 4 Short
Blunt Prongs

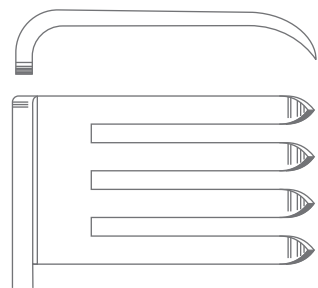

EI-762-30
4 x 4 Long
Sharp Prongs

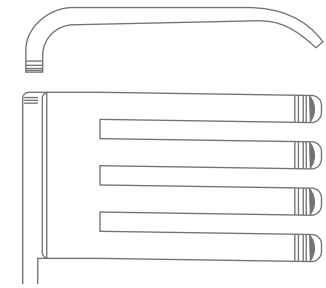

EI-763-30
4 x 4 Long
Blunt Prongs

Beckmann-Adson Self Retaining Retractor
Overall Length 30.5 cm (12")

Wound Spreaders, Self-Retaining
Wundspreizer
Separadores autoestáticos
Ecarteurs autostatiques
Divaricatori autostatici



EI-766-32
Beckmann-Eaton Self Retaining Retractor
7 x 7 Sharp Prongs
Overall Length 32 cm (12 1/2")

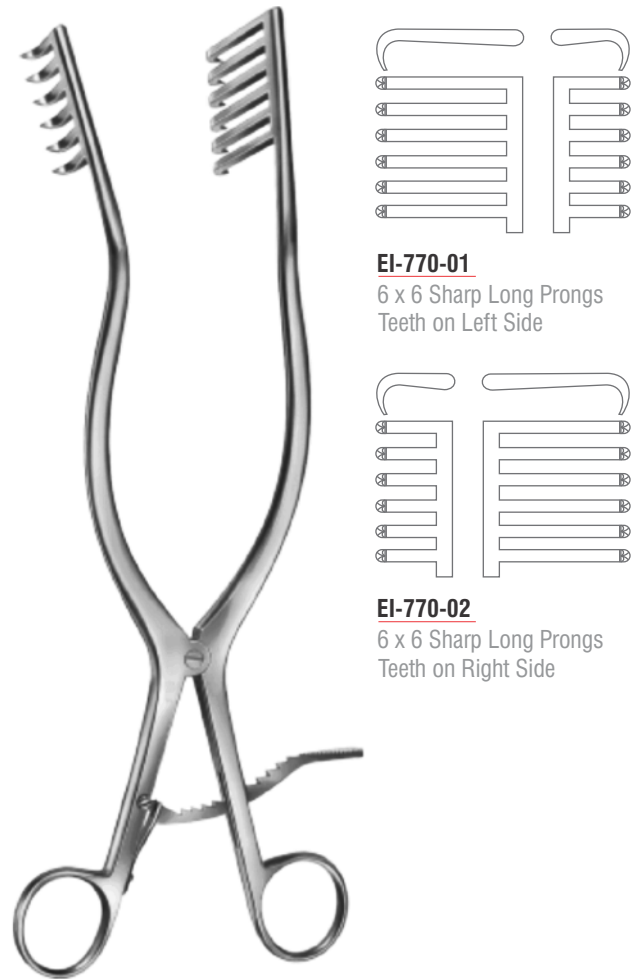

EI-770-01
6 x 6 Sharp Long Prongs
Teeth on Left Side

EI-770-02
6 x 6 Sharp Long Prongs
Teeth on Right Side

Beckmann-Eaton Self Retaining Retractor
Overall Length 28.5 cm (11 1/4")

Wound Spreaders, Self-Retaining
Wundspreizer
Separadores autoestáticos
Ecarteurs autostatiques
Divaricatori autostatici

EVA

RETRACTORS



EI-801-15
Joll (Friedman) Self Retaining Retractor
Thyroid and Vaginal Retractor
Overall Length 15.5 cm (6")



EI-805-13
13 cm (5")

EI-805-15
15 cm (6")

EI-805-18
18.5 cm (7 1/4")

Gelpi Self Retaining Retractor

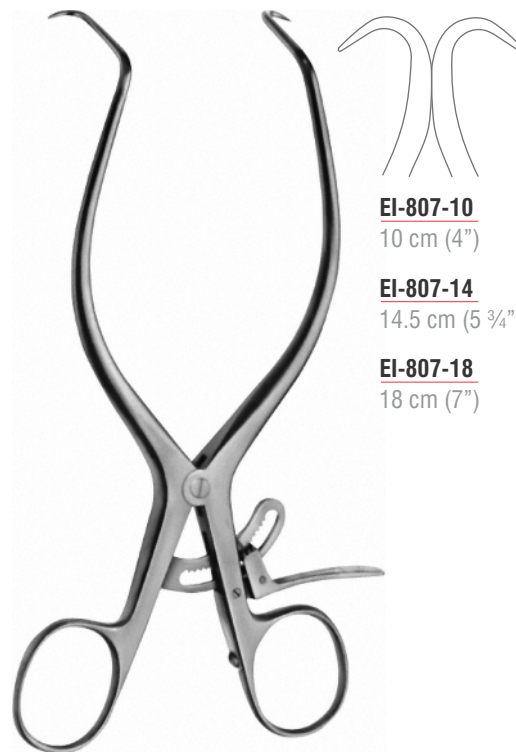

EI-807-10
10 cm (4")

EI-807-14
14.5 cm (5 3/4")

EI-807-18
18 cm (7")

Gelpi Self Retaining Retractor

Wound Spreaders, Self-Retaining
Wundspreizer
Separadores autoestáticos
Ecarteurs autostatiques
Divaricatori autostatici

9
220
210
8
200
190
7
180
170
6
160
150
5
140
130
4
120
110
3
100
90
80
2
70
60
1
50
40
30
20
10
INCHES
MILLIMETERS



EI-811-18
Gelpi Self Retaining Retractor
Overall Length 18.5 cm (7 1/4")



EI-813-18
Jackson-Burrows Self Retaining Retractor
Overall Length 18.5 cm (7 1/4")



EI-820-00
Collin-Baby Retractor Complete
Overall Length 20 cm (8")



EI-822-00
Collin Retractor Complete
With 1 Pair of Lateral Blades



EI-822-01
Collin Retractor Only
Without Blade
Overall Length 24 cm (9 1/2")

Abdominal Retractors
Bauchdeckenhalter
Separadores abdominales
Ecarteurs abdominaux
Divaricatori addominali

EVA

RETRACTORS



EI-8EI-00
Collin Retractor Complete
With Central Blades Ref: EI-8EI-90
and 1 Pair of Lateral Blades Ref: EI-835-38



EI-8EI-01
Collin Retractor Only
Without Blades
Overall Length 13 cm (5")

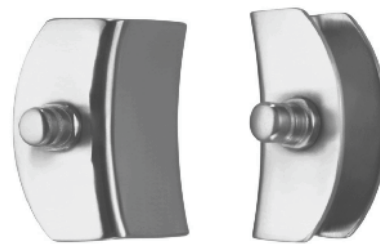

EI-8EI-90
Collin Central Blade
38 x 55 mm



EI-824-00
Collin Retractor Complete
With Central Blades Ref: EI-824-90
and 1 Pair of Lateral Blades Ref: EI-835-45
Overall Length 22.5 cm (8 3/4")

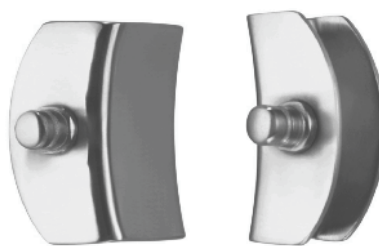

EI-824-90
Collin Central Blade
50 x 75 mm

Abdominal Retractors
Bauchdeckenhalter
Separadores abdominales
Ecarteurs abdominaux
Divaricatori addominali



EI-826-00
Collin Retractor Complete
With Central Blade Ref:- EI-826-90
and 1 Pair of Lateral Blades Ref:- EI-835-60



EI-826-01
Collin Retractor Only
Without Blade
Overall Length 31 cm (12 1/4")

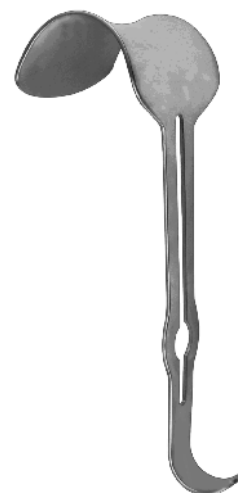

EI-826-90
Collin Retractor Only
60 x 75 mm

Abdominal Retractors
Bauchdeckenhalter
Separadores abdominales
Ecarteurs abdominaux
Divaricatori addominali

EVA

RETRACTORS



EI-830-00
Ricard Retractor Complete
With Central Blade Ref:- EI-830-02
and 1 Pair of Lateral Blades Ref:- EI-835-90



EI-830-01
Ricard Retractor Only



EI-830-02
Ricard Retractor Only
55 x 70 mm

Abdominal Retractors
Bauchdeckenhalter
Separadores abdominales
Ecarteurs abdominaux
Divaricatori addominali



EI-832-00
Ricard Retractor Complete
With Central Blade Ref:- EI-832-02
and 1 Pair of Lateral Blades Ref:- EI-835-92



EI-832-02
Ricard Retractor Only
80 x 90 mm

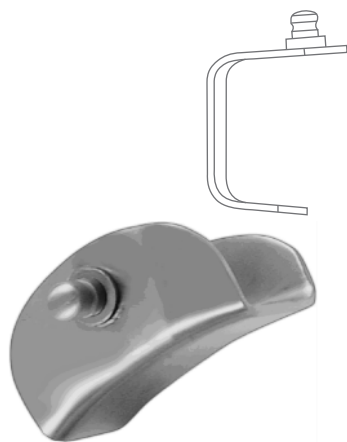

Ricard Central Blade

EI-835-18
18 x 40 mm

EI-835-27
27 x 40 mm

EI-835-38
38 x 60 mm

EI-835-40
40 x 80 mm

EI-835-45
45 x 80 mm

EI-835-50
50 x 70 mm

EI-835-52
52 x 70 mm

EI-835-60
60 x 80 mm

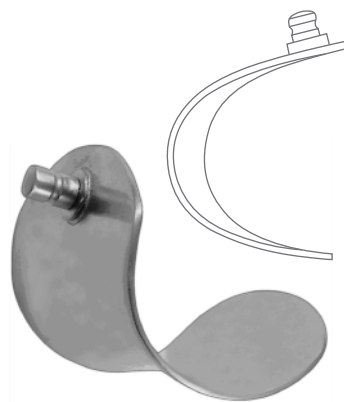

EI-835-70
70 x 55 mm

EI-835-80
75 x 90 mm

EI-835-90
50 x 58 mm

EI-835-92
60 x 80 mm

EI-835-94
72 x 85 mm



Abdominal Retractors
Bauchdeckenhalter
Separadores abdominales
Ecarteurs abdominaux
Divaricatori addominali

EVA

RETRACTORS

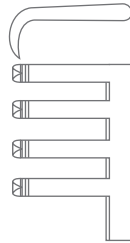

EI-840-01
3 x 4 Sharp Prongs
With 3 Central Blades
Ref:- EI-840-19, EI-840-25
and EI-840-32

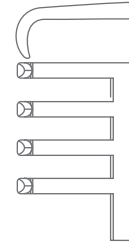

EI-840-02
3 x 4 Blunt Prongs
With 3 Central Blades
Ref:- EI-840-19, EI-840-25
and EI-840-32

Henley Retractor Complete
Overall Length 16 cm (6 1/4")

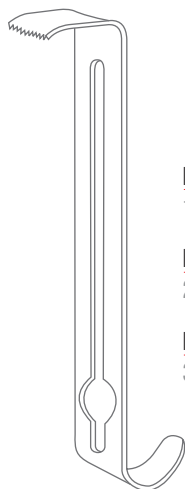

EI-840-19
19 x 17 mm

EI-840-25
25 x 17 mm

EI-840-32
32 x 17 mm

Henley Central Blade

Abdominal Retractors
Bauchdeckenhalter
Separadores abdominales
Ecarteurs abdominaux
Divaricatori addominali



EI-850-00
Millin Retractor Complete
With Central Blade Ref:- EI-850-90, 1 Pair Each of
Lateral Blades Ref:- EI-851-57 and Ref:- EI-851-82



EI-850-01
Millin Retractor Only

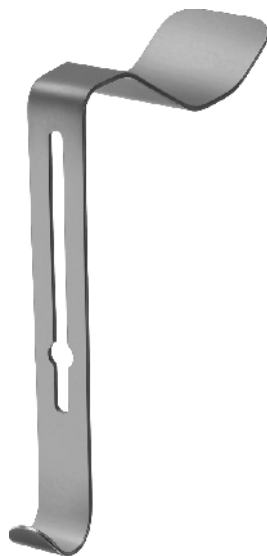

EI-850-90
Millin Central Blade Only
105 x 45 mm



EI-851-57
57 x 25 mm

EI-851-82
82 x 25 mm

Millin Lateral Blade

Abdominal Retractors
Bauchdeckenhalter
Separadores abdominales
Ecarteurs abdominaux
Divaricatori addominali

EVA

RETRACTORS



EI-853-26
Lagueu Retractor
90 x 35 mm
Overall Length 26 cm (10 1/4")



EI-855-28
Millin Retractor
70 mm
Overall Length 28 cm (11")



EI-858-00
Judd-Masson Retractor
Spread 120 mm

Abdominal Retractors
Bauchdeckenhalter
Separadores abdominales
Ecarteurs abdominaux
Divaricatori addominali



EI-861-00
Vickers Low-Profile Retractor Complete
2 x 2 Blunt Prongs, With Central Blade
Ref:- EI-801-01
Overall Length 7.5 cm (3")

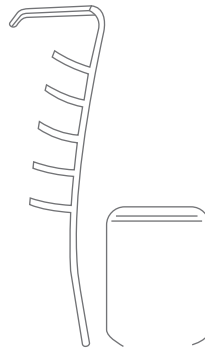

Vickers Low-Profile Central Blade

EI-861-01
10 x 18 mm

EI-861-02
12 x 10 mm



EI-863-00
Vickers Low-Profile Retractor Complete
3 x 3 Blunt Prongs, With Central Blade
Ref:- EI-861-01
Overall Length 9 cm (3 1/2")



EI-865-00
Vickers Low-Profile Retractor Complete
With Central Blade Ref:- EI-861-01
Overall Length 7.5 cm (3")

Abdominal Retractors
Bauchdeckenhalter
Separadores abdominales
Ecarteurs abdominaux
Divaricatori addominali

EVA

RETRACTORS



EI-869-00
Vickers Self Retaining Retractor
Blunt Ring Model For Thumb And Fingers
Overall Length 5 cm (2")

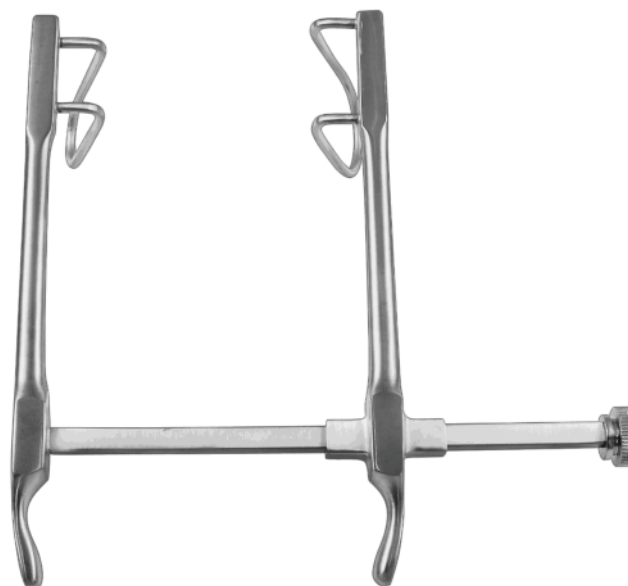

EI-880-00
Gosset-Baby Retractor
120 mm, 40 x 30 mm
Overall Length 12.5 cm (5")

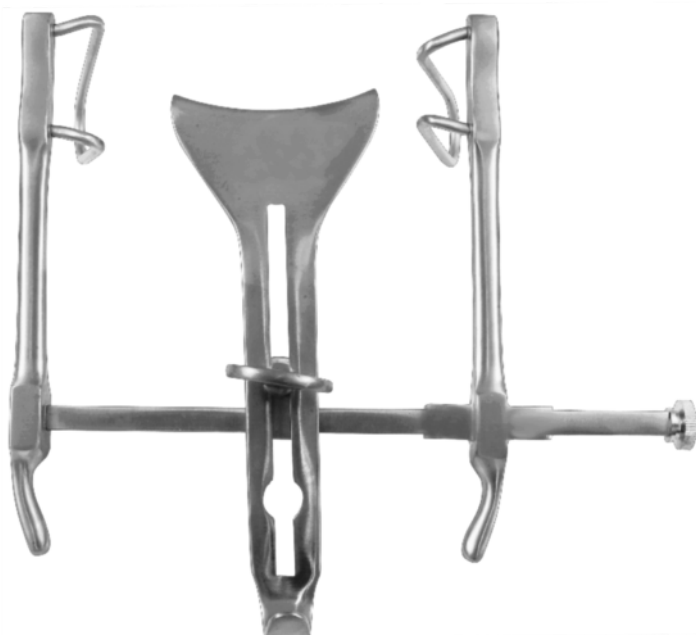

EI-884-00
Gosset Retractor Complete
With Central Blade Ref:- EI-884-90
160 mm, 63 x 35 mm
Overall Length 16.5 cm (6 1/2")



EI-844-90
Gosset Central Blade
60 x 56 mm

Abdominal Retractors
Bauchdeckenhalter
Separadores abdominales
Ecarteurs abdominaux
Divaricatori addominali

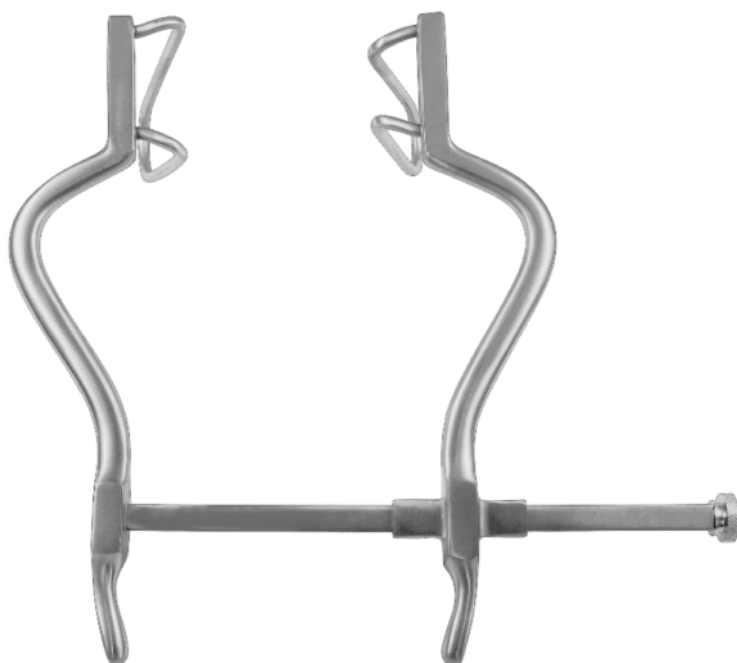

EI-886-00
Gosset Retractor
Overall Length 18.5 cm (7 1/4")

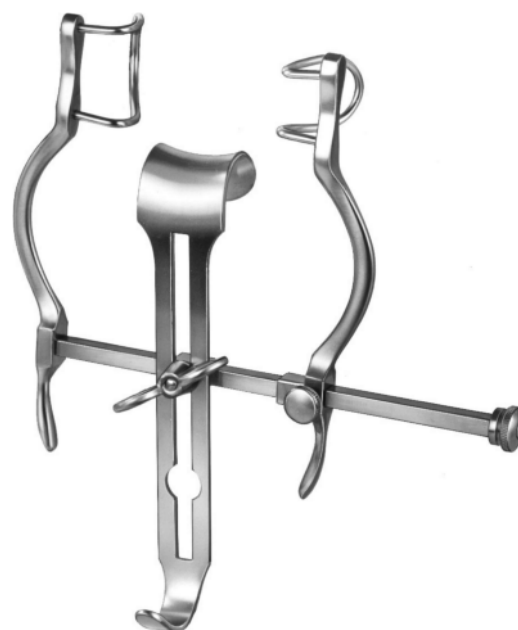

EI-890-00
Balfour-Baby Retractor Complete
With Central Blade Ref:- EI-890-90
95 mm
Overall Length 12.5 cm (5")

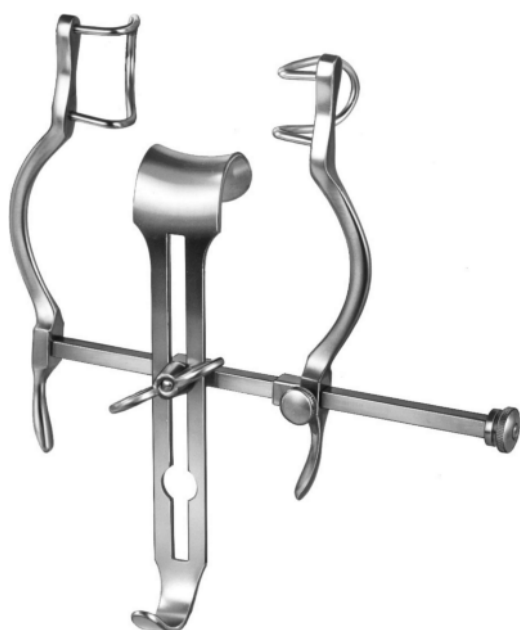

EI-890-90
Balfour-Baby Central Blade
24 x 20 mm



Abdominal Retractors
Bauchdeckenhalter
Separadores abdominales
Ecarteurs abdominaux
Divaricatori addominali

EVA

RETRACTORS

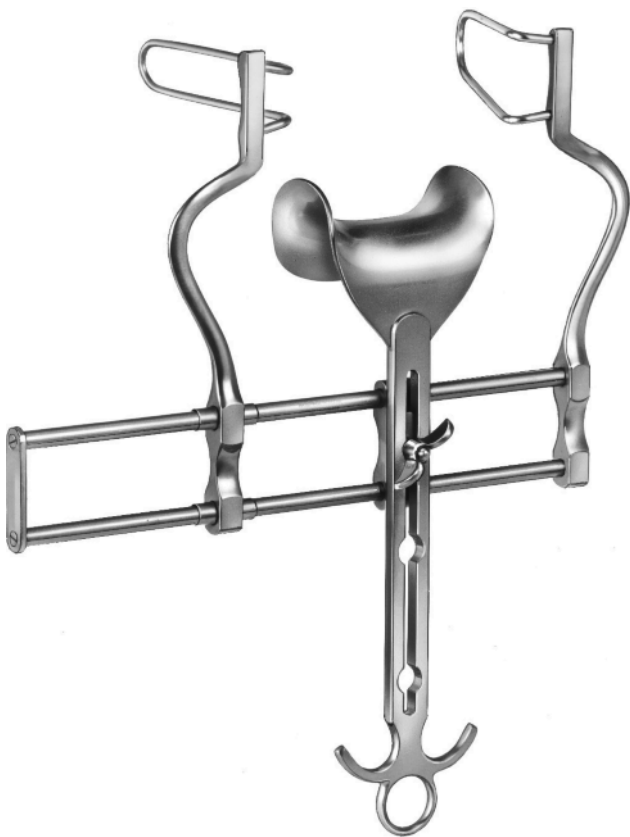

EI-892-00

Systruk Nail Splitting Scissor

With Central Blade Ref:- EI-903-01

180 mm, 70 x 35 mm

Overall Length 20 cm (8")

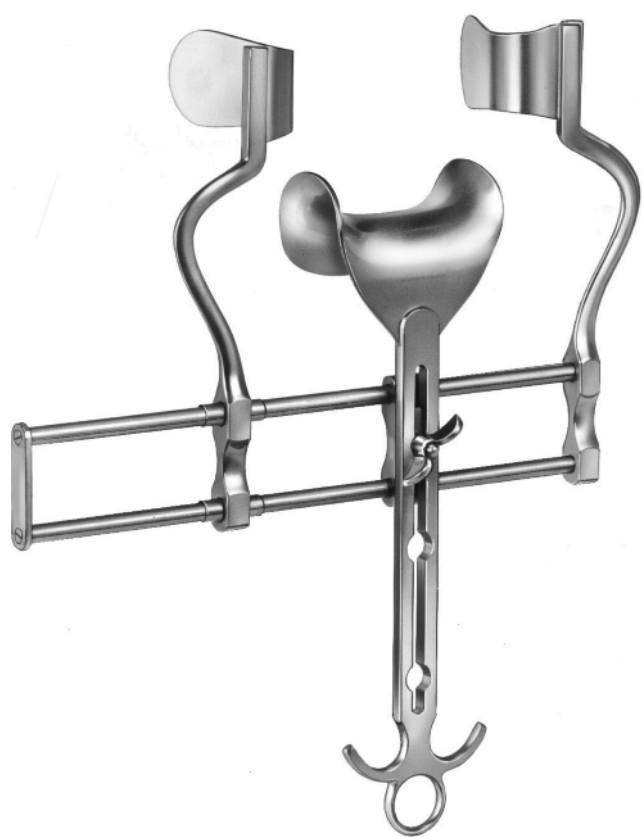

EI-894-00

Balfour Retractor Complete

With Central Blade Ref:- EI-903-01

180 mm, 70 x 35 mm

Overall Length 20 cm (8")

Abdominal Retractors
Bauchdeckenhalter
Separadores abdominales
Ecarteurs abdominaux
Divaricatori addominali



EI-896-00
Balfour Retractor Complete
With Central Blade Ref:- EI-903-01
200 mm, 100 x 35 mm
Overall Length 20 cm (8")

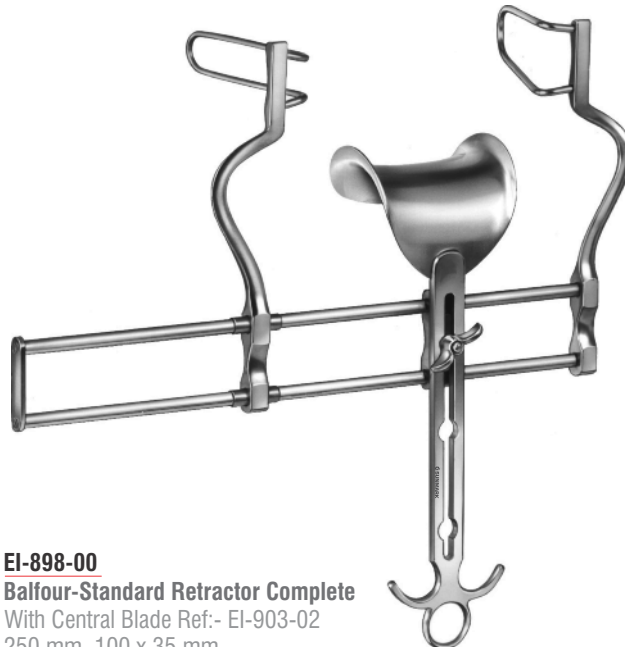

EI-898-00
Balfour-Standard Retractor Complete
With Central Blade Ref:- EI-903-02
250 mm, 100 x 35 mm
Overall Length 20 cm (8")



EI-901-90
100 x 70 mm

EI-901-91
100 x 60 mm

Balfour Central Blade



EI-903-01
40 x 80 mm

EI-903-02
68 x 85 mm

EI-903-03
40 x 68 mm

Balfour Central Blade



Abdominal Retractors
Bauchdeckenhalter
Separadores abdominales
Ecarteurs abdominaux
Divaricatori addominali

EVA

RETRACTORS

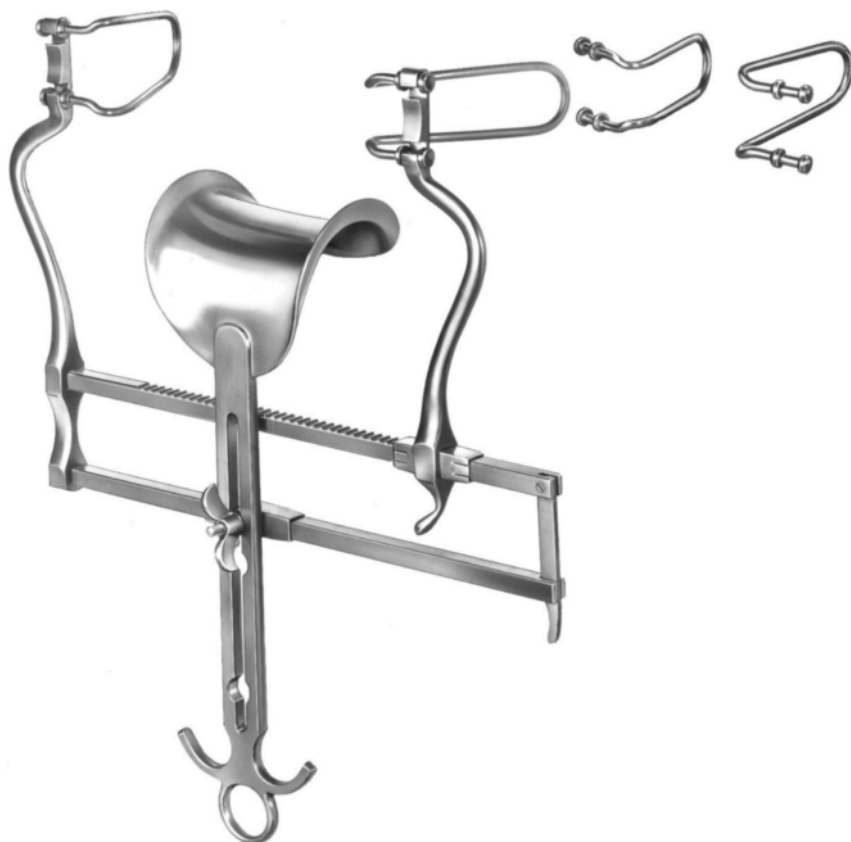

EI-906-00

Balfour-Modell USA Retractor Complete

With 1 Pair Each of Lateral Blades Ref:- EI-906-06 and
EI-906-08 and Central Blade EI-903-02
Spread 190 mm



EI-906-06
60 mm Deep

EI-906-08
80 mm Deep

Balfour-Modell USA Lateral Blade

Abdominal Retractors
Bauchdeckenhalter
Separadores abdominales
Ecarteurs abdominaux
Divaricatori addominali



EI-910-00
Goligher Retractor Complete
With Central Blades Ref:- EI-910-90
and EI-910-91
Spread 185 mm



EI-910-05
51 mm Deep
EI-910-10
102 mm Deep

Goligher Lateral Blade



EI-910-90
51 mm Deep
EI-910-91
102 mm Deep

Goligher Central Blade

Abdominal Retractors
Bauchdeckenhalter
Separadores abdominales
Ecarteurs abdominaux
Divaricatori addominali

EVA

RETRACTORS



EI-914-00
Charnley Retractor Complete



EI-914-90
Weight & Chain Charnley Retractor
Total 950 Grams



EI-920-00
O'Sullivan-O'Connor Retractor Complete
With 2 Fixed Blades, 1 Blade Ref:- EI-910-91 and
2 Blades Ref:- EI-910-90



EI-920-90
80 x 45 mm

EI-920-91
110 x 70 mm

O'Sullivan-O'Connor Blade

Abdominal Retractors
Bauchdeckenhalter
Separadores abdominales
Ecarteurs abdominaux
Divaricatori addominali

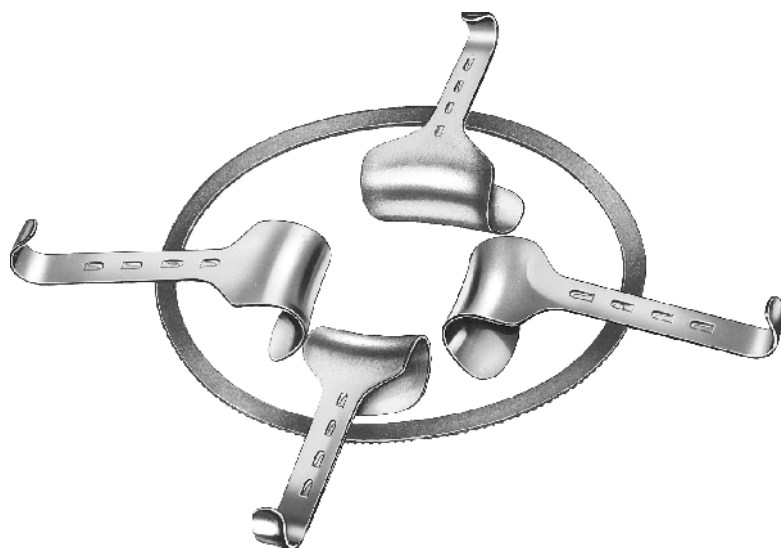

EI-922-00
Kirschner Retractor Complete
With Frame EI-920-30, 3 Blades Ref:- EI-9EI-50 and
1 Blade Each of EI-9EI-80, EI-9EI-98 and EI-9EI-99

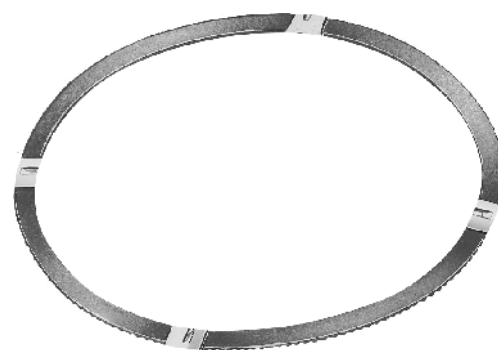

EI-922-30
Kirschner Frame Only
340 x 240 mm

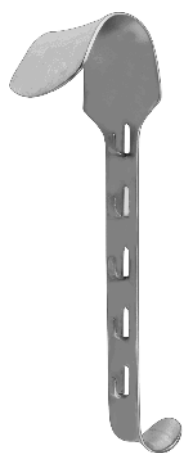

EI-9EI-40
40 x 55 mm

EI-9EI-50
50 x 65 mm

EI-9EI-60
60 x 85 mm

EI-9EI-78
78 x 65 mm

EI-9EI-80
80 x 90 mm

Kirschner Blade



EI-9EI-98
98 x 50 mm

EI-9EI-99
105 x 35 mm

Kirschner Blade

Abdominal Retractors
Bauchdeckenhalter
Separadores abdominales
Ecarteurs abdominaux
Divaricatori addominali

EVA

RETRACTORS

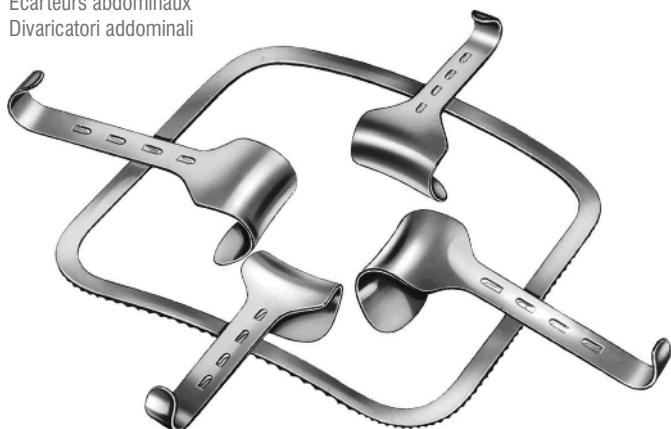

EI-924-00
Kirshner Retractor Complete
With Frame EI-924-24, 2 Blades Ref:- EI-9EI-40
and 2 Blades Ref:- EI-9EI-50

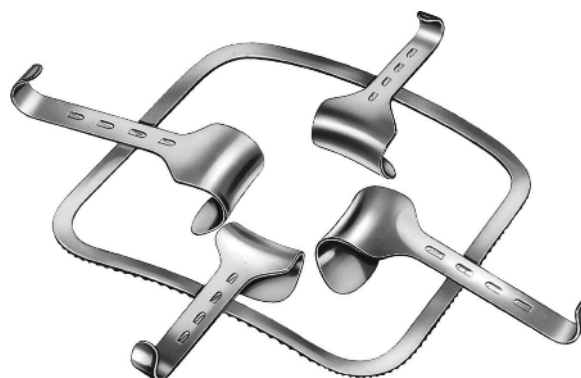

EI-924-24
Kirshner Frame Only
240 x 240 mm

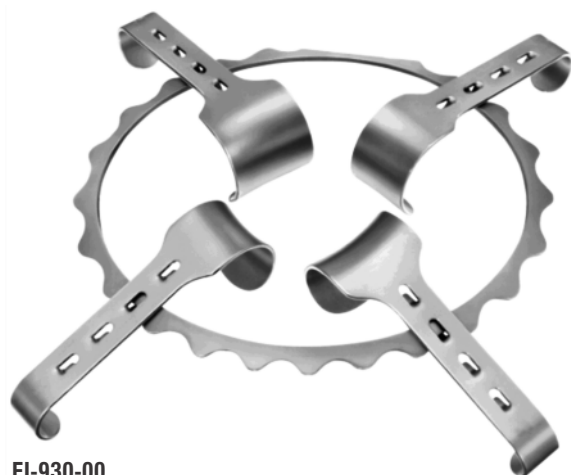

EI-930-00
Dennis-Browne Retractor Complete
With Frame EI-930-15 & 2 Blades Each
Ref:- EI-930-30 and EI-930-40

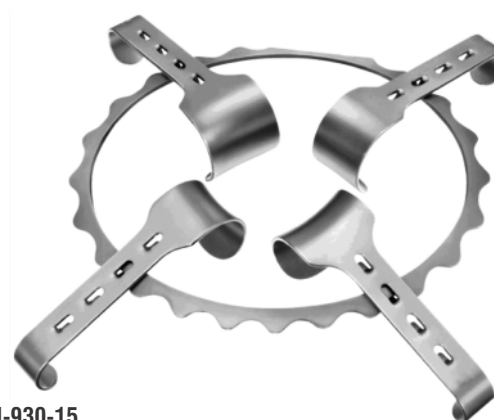

EI-930-15
Dennis-Browne Retractor Frame Only
175 mm x 150 mm



EI-930-30
40 mm x 30 mm

EI-930-40
40 mm x 40 mm

Dennis-Browne Retractor Blade Only

Wound Spreaders, self-retaining
Wundspreizer
Separadores autoestáticos
Ecarteurs autostatiques
Divaricatori autostatici



EI-940-00
Cloward Retractor Complete
With 2 Each Lateral Blades Ref:- EI-941-40
and EI-941-60



EI-940-01
Cloward Retractor Only
Overall Length 25 cm (9 3/4")



Cloward Lateral Blade
Toothed

- | | |
|---------------------------|---------------------------|
| EI-941-40
40 mm | EI-941-55
55 mm |
| EI-941-45
45 mm | EI-941-60
60 mm |
| EI-941-50
50 mm | |

Wound Spreaders, self-retaining
Wundspreizer
Separadores autoestáticos
Ecarteurs autostatiques
Divaricatori autostatici

EVA

RETRACTORS



EI-944-00
Cloward Retractor Complete
Complete with 2 Lateral Blades EI-945-40
and EI-945-60



EI-944-01
Cloward Retractor Frame Only
Overall Length 15 cm (6")



- | | |
|---------------------------|---------------------------|
| EI-945-40
40 mm | EI-945-55
55 mm |
| EI-945-45
45 mm | EI-945-60
60 mm |
| EI-945-50
50 mm | |

Cloward Lateral Blade

Laminectomy Retractors
Laminektomiesperrer
Separadores para laminectomia
Ecarteurs pour laminectomie
Divaricatori per laminectomia

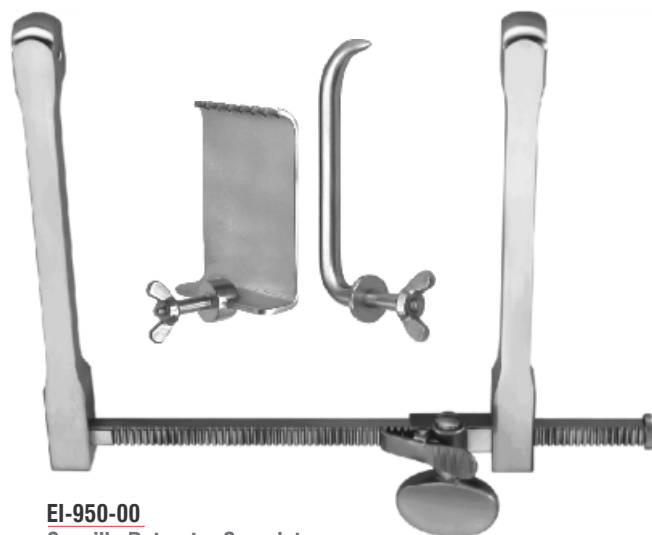

EI-950-00
Scoville Retractor Complete
With Lateral Blades Ref:- EI-953-06 and EI-953-11

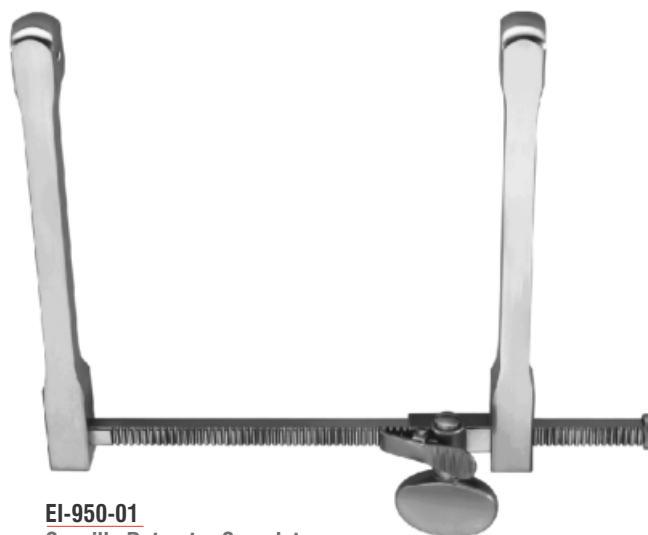

EI-950-01
Scoville Retractor Complete
Spread 150 mm



EI-952-00
Scoville-Haverfield Retractor Complete
With Lateral Blades Ref:- EI-953-06
and EI-953-11



EI-952-01
Scoville-Haverfield Retractor Frame Only
Hinged
Spread 150 mm

Laminectomy Retractors
Laminektomiesperrer
Separadores para laminectomía
Ecarteurs pour laminectomie
Divaricatori per laminectomia

EVA

RETRACTORS



EI-953-01
50 mm

EI-953-02
70 mm

Scoville Lateral Blade
Blunt

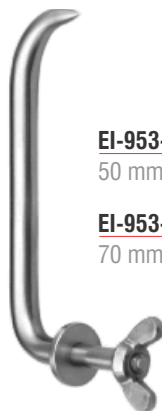

EI-953-01
50 mm

EI-953-02
70 mm

Scoville Lateral Blade
Sharp



EI-953-11
60 x 25 mm

EI-953-12
64 x 50 mm

EI-953-13
88 x 25 mm

Scoville Lateral Blade
Toothed



EI-953-41
48 x 50 mm

EI-953-42
60 x 50 mm

EI-953-43
64 x 64 mm

EI-953-44
80 x 57 mm

Taylor Lateral Blade
Sharp



EI-953-46
41 x 38 mm

EI-953-47
80 x 57 mm

Scoville Lateral Blade
Sharp



EI-956-00
Scoville-Richter Retractor Complete
With Lateral Blades Pair Ref:- EI-957-01



EI-956-01
Scoville-Richter Frame Only
Spread 155 mm

Laminectomy Retractors
Laminektomiesperrer
Separadores para laminectomia
Ecarteurs pour laminectomie
Divaricatori per laminectomia

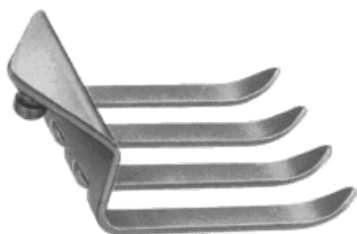

EI-957-01
Lateral Blade Pair
62 x 52 mm, 62 x 37 mm



EI-957-02
Lateral Blade
47 x 51 mm



EI-957-03
Lateral Blade
30 x 40 mm



EI-957-04
Lateral Blade
37 x 62 mm



EI-960-00
Caspar Retractor Complete



EI-960-01
Caspar Retractor Complete
With Key Ref: EI-960-02

Laminectomy Retractors
Laminektomiesperrer
Separadores para laminectomía
Ecarteurs pour laminectomie
Divaricatori per laminectomia

EVA

RETRACTORS



EI-960-02
Key For Caspar Retractor

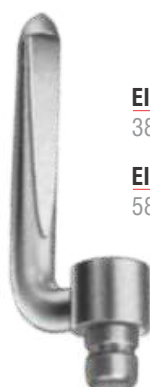

EI-961-01
38 mm

EI-961-02
58 mm

Caspar Hook



EI-961-03
32 x 22 mm

EI-961-07
52 x 22 mm

EI-961-04
37 x 22 mm

EI-961-08
57 x 22 mm

EI-961-05
42 x 22 mm

EI-961-09
62 x 22 mm

EI-961-06
47 x 22 mm

EI-961-10
67 x 22 mm

Caspar Lateral Blade
Blade With 2 Prongs



EI-961-11
32 x 37 mm

EI-961-15
52 x 37 mm

EI-961-12
37 x 37 mm

EI-961-16
57 x 37 mm

EI-961-13
42 x 37 mm

EI-961-17
62 x 37 mm

EI-961-14
47 x 37 mm

EI-961-18
67 x 37 mm

Caspar Lateral Blade
Blade With 3 Prongs



EI-961-19
38 x 37 mm

EI-961-23
52 x 37 mm

EI-961-20
37 x 37 mm

EI-961-24
57 x 37 mm

EI-961-21
42 x 37 mm

EI-961-25
62 x 37 mm

EI-961-22
47 x 37 mm

EI-961-26
67 x 37 mm

Caspar Lateral Blade
Blade With 4 Prongs

Laminectomy Retractors
Laminektomiesperrer
Separadores para laminectomia
Ecarteurs pour laminectomie
Divaricatori per laminectomia



EI-9EI-16
Cloward Lamina Spreader
Overall Length 16 cm (6 1/4")



EI-975-13
Cloward Lamina Spreader
Overall Length 13.5 cm (5 1/4")



EI-9EI-17
16 cm (6 1/4")

EI-979-27
25.5 cm (10")

Inge Lamina Spreader

Probes
Knopfsonden
Sondas abotonadas
Sondes boutonées
Sonde a bottone



Overall Length	Ø 1.0 mm	Ø 1.5 mm	Ø 2.0 mm
11.5 cm (4 ½")	<u>EI-010-11</u>	<u>EI-015-11</u>	<u>EI-020-11</u>
13 cm (5")	<u>EI-010-13</u>	<u>EI-015-13</u>	<u>EI-020-13</u>
14.5 cm (5 ¾")	<u>EI-010-14</u>	<u>EI-015-14</u>	<u>EI-020-14</u>
16 cm (6 ¼")	<u>EI-010-16</u>	<u>EI-015-16</u>	<u>EI-020-16</u>
18 cm (7")	<u>EI-010-18</u>	<u>EI-015-18</u>	<u>EI-020-18</u>
20 cm (8")	<u>EI-010-20</u>	<u>EI-015-20</u>	<u>EI-020-20</u>
25 cm (9 ¾")		<u>EI-015-25</u>	<u>EI-020-25</u>
30 cm (11 ¾")			<u>EI-020-30</u>

Probe



Probe
With Eye

[EI-030-13](#)

Ø 2 mm
13 cm (5")

[EI-030-13](#)

Ø 2 mm
14.5 cm (5 ¾")

[EI-030-13](#)

Ø 2 mm
16 cm (6 ¼")



[EI-040-10](#)
Stacke (Silver) Probe
Ø 1 mm
Overall Length 10 cm (4")



[EI-050-10](#)
Cawthrone Probe
Flattened End
Overall Length 14 cm (5 ½")



Myrtle Leaf Probe

[EI-070-13](#)

Ø 2 mm
13 cm (5")

[EI-070-14](#)

Ø 2 mm
14.5 cm (5 ¾")

[EI-070-16](#)

Ø 2 mm
16 cm (6 ¼")

[EI-070-18](#)

Ø 2 mm
18 cm (7")

[EI-070-20](#)

Ø 2 mm
20 cm (8")

Probes
Knopfsonden
Sondas abotonadas
Sondes boutonnées
Sonde a bottone



EI-081-16
Killian Probe
Overall Length
16.5 cm (6 1/2")



EI-083-16
Probe
Overall Length
16 cm (6 1/4")



EI-086-35
Ochsner Gall Stone Probe
Overall Length 35 cm (13 3/4")



Mayo Common Duct Probe
Malleable
Overall Length 25.5 cm (10")



EI-088-05
5.0 mm

EI-088-06
6.0 mm



EI-091-19
Seiffert Probe
Overall Length
19.5 cm (7 3/4")

Probes, Grooved Directors
Knopfsonden, Hohlsonden
Sondas abotonadas, Sondas acanaladas
Sondes boutonnées, Sondes cannelées
Sonde a bottone, Sonde cannellate



EI-100-13
13 cm (5")

EI-100-14
14 cm (5 1/2")

EI-100-16
16 cm (6 1/4")

Butterfly Probe/Grooved Director



EI-120-13
13 cm (5")

EI-120-14
14.5 cm (5 3/4")

EI-120-16
16 cm (6 1/4")

**Butterfly Probe/Grooved Director
With Tip**



EI-131-14
Doyen Butterfly Probe/Grooved Director
Overall Length 14.5 cm (5 3/4")



EI-141-16
Nelaton Butterfly Probe/Grooved Director
Overall Length 16 cm (6 1/4")



EI-150-20
Brodie Butterfly Probe/Grooved Director
Ø 3.5 mm
Overall Length 20 cm (8")

Probes
Knopfsonden
Sondas abotonadas
Sondes boutonées
Sonde a bottone



EI-200-00
Bowman Probes Complete
Set of 6 Probes
Overall Length 13 cm (5")

EI-202-00	EI-204-00	EI-204-12	EI-204-34	EI-204-56	EI-204-78
Fig. 0000/000	Fig. 00/0	Fig. 1/2	Fig. 3/4	Fig. 5/6	Fig. 7/8
Tip Diameter 0.4 mm - 0.5 mm	Tip Diameter 0.7 mm - 0.8 mm	Tip Diameter 0.9 mm - 1.1 mm	Tip Diameter 1.3 mm - 1.4 mm	Tip Diameter 1.5 mm - 1.6 mm	Tip Diameter 1.8 mm - 1.9 mm

Bowman Probes
Overall Length 13 cm (5")

Varix Instruments
Varizeninstrumente
Instrumentos para varices
Instruments pour varices
Strumenti per varici

EVA



EI-251-01
LockhaEI-Mummery
Fistula Probe
Fig. 1
Overall Length 16.5 cm (6 1/2")



EI-251-02
LockhaEI-Mummery
Fistula Probe
Fig. 2
Overall Length 16.5 cm (6 1/2")



EI-251-03
LockhaEI-Mummery
Fistula Probe
Fig. 3
Overall Length 16.5 cm (6 1/2")



EI-251-04
LockhaEI-Mummery
Fistula Probe
Fig. 4
Overall Length 16.5 cm (6 1/2")

Varix Instruments
Varizeninstrumente
Instrumentos para varices
Instruments pour varices
Strumenti per varici



Pratt Fistula Probe
Overall Length 21 cm (8 1/4")

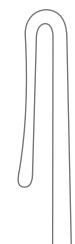

EI-261-01
Fig. 1

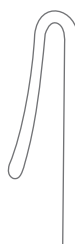

EI-261-02
Fig. 2



EI-261-03
Fig. 3



EI-300-00
Nabatoff Varicose Vein Probes Complete Set



EI-300-02



EI-300-03
Ø 3 mm
Olive Shaped



EI-300-06
Ø 6 mm
Olive Shaped



EI-300-09
Ø 9 mm
Olive Shaped



EI-300-12
Ø 12 mm
Olive Shaped



EI-300-15
Ø 15 mm
Olive Shaped

Nabatoff Vein Probe

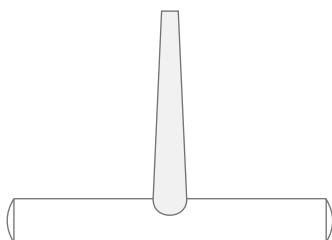

EI-300-80
Nabatoff T Shaped Handle

Ring Strippers
Ringstripper
Fleboextractores
Strippers à anneau
Stripper anello

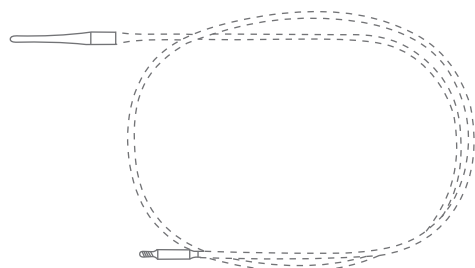

EI-300-90
Nabatoff Traction Cable



EI-400-11
Vollmar Handle
Overall Length 11.5 cm (4 1/2")

EI-401-02
Ø 2 mm

EI-401-03
Ø 3 mm

EI-401-04
Ø 4 mm

EI-401-06
Ø 6 mm

EI-401-07
Ø 7 mm

EI-401-08
Ø 8 mm

EI-401-10
Ø 10 mm

EI-401-12
Ø 12 mm

EI-401-14
Ø 14 mm

Vollmar Ring Stripper
Overall Length 50 cm (19 3/4")



EI-500-12
Ø 0.9 mm
12 cm (4 3/4")

EI-500-14
Ø 0.9 mm
14 cm (5 1/2")

EI-500-16
Ø 1.1 mm
16 cm (6 1/4")

EI-500-18
Ø 1.2 mm
18 cm (7")

Farrell Cotton Applicator
Round Spiral End

Probes
Knopfsonden
Sondas abotonadas
Sondes boutonées
Sonde a bottone



Farrell Cotton Applicator
Triangular Shaped End

EI-520-12
Ø 0.9 mm
12 cm (4 ¾")

EI-520-14
Ø 0.9 mm
14 cm (5 ½")

EI-520-16
Ø 1.1 mm
16 cm (6 ¼")

EI-520-18
Ø 1.2 mm
18 cm (7")



Cotton Application
Round Spiral End
Overall Length 18 cm (7")

EI-540-15
Ø 1.5 mm

EI-520-14
Ø 1.8 mm



EI-551-22
Hartmann Cotton Application
Round Spiral End, Ø 2.3 mm
Overall Length 22 cm (8 ½")



EI-561-15
Jobson-Horne Ear Probe
Double Ended
Overall Length 15 cm (6")

Varix Instruments
 Varizeninstrumente
 Instrumentos para varices
 Instruments pour varices
 Strumenti per varici

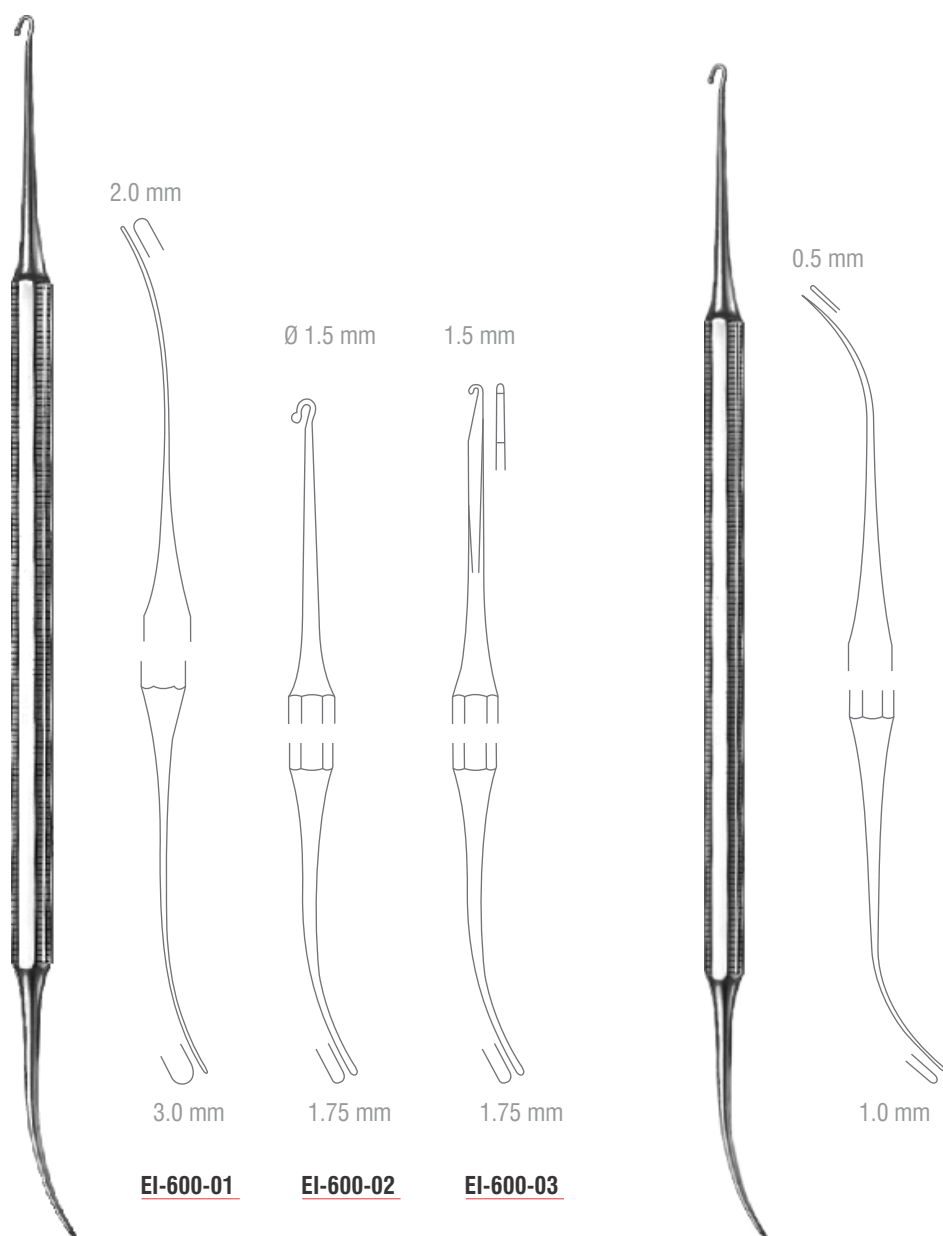

Varady Varix Instrument
 Phlebodissector
 Overall Length 18 cm (7")

EI-600-04
Varady Varix Instrument
 Micro Spatula
 Overall Length 17.5 cm (7")

Varix Instruments
Varizeninstrumente
Instrumentos para varices
Instruments pour varices
Strumenti per varici

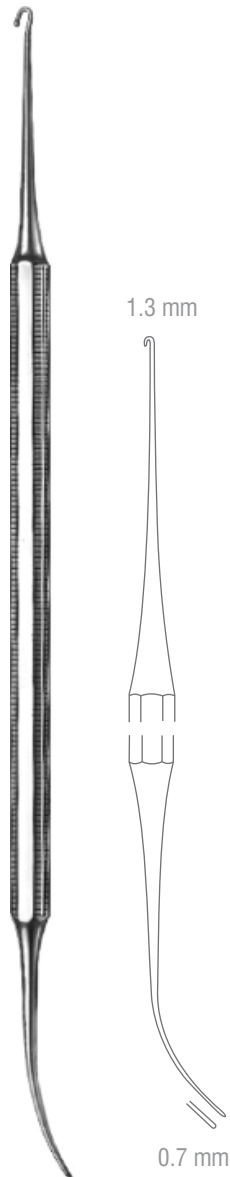

EI-600-05
Varady Varix Instrument
Micro Phleboextractor
Overall Length 18 cm (7")

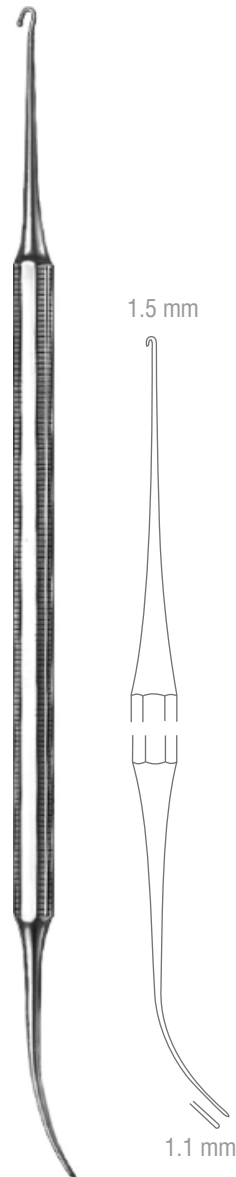

EI-600-06
Varady Varix Instrument
Mini Phleboextractor
Overall Length 18 cm (7")

Percussion Hammers
Perkussionshämmer
Martillos para reflejos
Marteaux-percuteurs
Martelli percussori



EI-100-18
Buck Percussion Hammer
With Needle and Brush
Overall Length 18.5 cm (7 ¼")



EI-110-20
Dejerine Percussion Hammer
Overall Length 20 cm (8")



EI-112-21
Dejerine Percussion Hammer
Overall Length 21 cm (8 ¼")

Percussion Hammers
 Perkussionshämmer
 Martillos para reflejos
 Marteaux-percuteurs
 Martelli percussori



EI-120-20
Taylor Mod. USA Percussion Hammer
 Overall Length 20 cm (8")



EI-130-22
Babinsky Percussion Hammer
 With Needle
 Overall Length 22 cm (8 3/4")



EI-132-23
Rabiner Percussion Hammer
 Overall Length 23 cm (9")



Stethoscopes, Head Lamps
Stethoskope, Stirnlampen
Estetoscopios, Lámparas frontales
Stéthoscopes, Eclaireurs frontaux
Stetoscopi, Lampada frontale



EI-210-19
Wartenberg Sensibility Instrument
Overall Length 19 cm (7 1/2")



EI-300-18
Pinard Stethoscope
Wood
Overall Length 18 cm (7")



EI-310-15
Pinard Stethoscope
Aluminium
Overall Length 15 cm (6")



EI-600-09
Ziegler Head Mirror
Without Protection Cap
Ø 90 mm



EI-601-09
Ziegler Head Mirror
With Protection Cap
Ø 90 mm

Head Lamps
Stirnlampen
Lámparas frontales
Eclaireurs frontaux
Lampada frontale



EI-611-06
Clar Head Light Complete
With Transformer
Ø 55 mm, 6 Volts



EI-615-06
Clar Head Light Complete
With Transformer
Ø 100 mm, 6 Volts



EI-651-06
Head Light
Xenon Light



Diagnostic Set
Diagnostikbesteck
Juego para Diagnóstico
Jeu pour diagnostic
Set per diagnostica



EI-730-00
Corona™ Premium EENT Diagnostic Set



EI-732-00
Corona™ Premium Otoscope



EI-7E1-00
Corona™ Premium Ophthalmoscope



EI-740-00
Apollo™ Standard Universal EENT Diagnostic Set



Diagnostic Set, Calipers
 Diagnostikbesteck, Meßzirkel
 Juego para Diagnóstico, Compases
 Jeu pour diagnostic, Compas
 Set per diagnostica, Compassi



EI-742-00
Apollo™ Standard Otoscope



EI-744-00
Apollo™ Standard Ophthalmoscope



EI-750-00
Apollo™ Standard Dermatoscope



EI-801-00
Jameson Caliper



EI-805-11
Townley Caliper
 Graduated in mm and inches
 Overall Length 11.5 cm (4 ½")

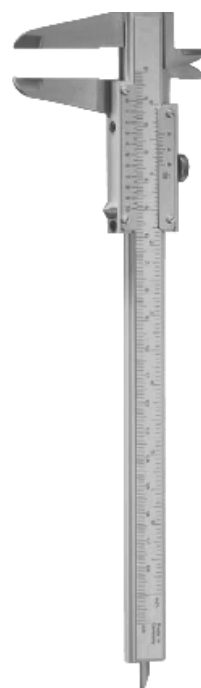

EI-831-03
Vernier Caliper
 Graduated in mm and inches, 150 mm
 Overall Length 23.5 cm (9 ¼")

Calipers
Schieblehren
Calibres
Pieds à coulisse
Calibro



EI-833-22
Vernier Caliper
Graduated in mm and inches, 145 mm
Overall Length 22.5 cm (8 ¾")



EI-841-00
Boley Caliper
100 mm



EI-845-00
Measuring Caliper
100 mm



EI-850-15
15 mm
8 cm (3")

EI-850-20
20 mm
8 cm (3")

Castroviejo Caliper
Straight



EI-851-20
Castroviejo-Epker Caliper
20 mm
Overall Length 8 cm (3")

Calipers, Rulers
Schieblehren, Maßstäbe
Calibres, Reglas
Pieds à coulisse, Règles à mesurer
Calibro, Misuratori



Castroviejo Caliper
Curved

EI-852-09
40 mm
9 cm (3 1/2")

EI-852-18
40 mm
18 cm (7")

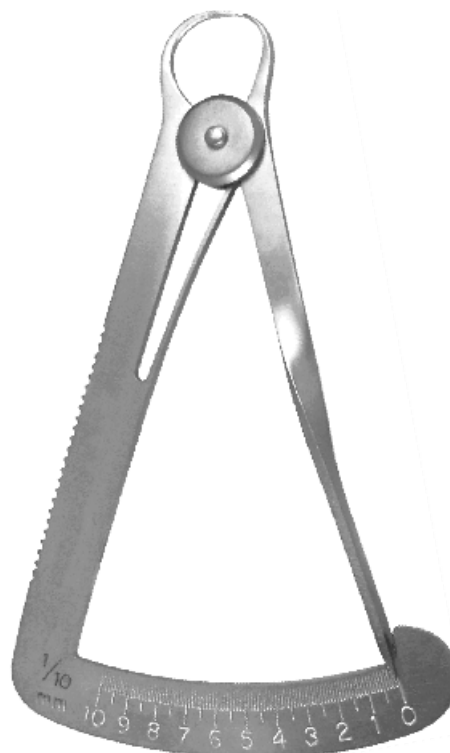

EI-860-10
Iwanson Caliper
Straight
Overall Length 10 cm (4")



EI-880-15
150 mm
10 cm (4")

EI-852-18
300 mm
31.5 cm (12 1/2")

Ruler
Graduated in mm and inches



Trocars
Trokare
Trócares
Trocart
Trequarti



EI-010-00
Universal Trocar
With 4 Trocar Tips Diameter 1.7 mm,
3.0 mm, 4.5 mm and 6.0 mm
Overall Length 14.5 cm (5 3/4")



EI-020-07
Fig. 1
Ø 7.5 mm
22 Charr.

EI-020-09
Fig. 2
Ø 9.5 mm
28 Charr.

EI-020-11
Fig. 1
Ø 11.0 mm
33 Charr.

Nelson Trocar
22 FG
Overall Length 20 cm (8")

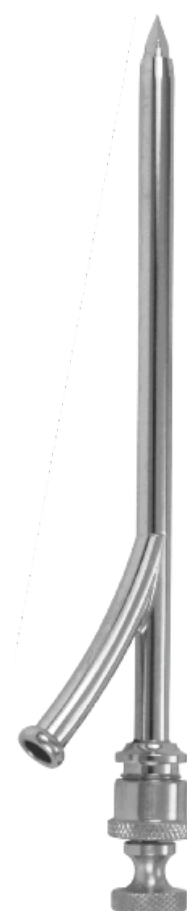

EI-030-01
Ø 4 mm

EI-030-02
Ø 4.6 mm

EI-030-03
Ø 5.3 mm

EI-030-04
Ø 6.0 mm

EI-030-05
Ø 6.6 mm

EI-030-06
Ø 7.3 mm

EI-030-07
Ø 8.0 mm

EI-030-08
Ø 8.6 mm

Ochsner Trocar
Overall Length 14 cm (5 1/2")

Suction Tubes
Sauger
Tubos de aspiración
Tubes d'aspiration
Tubi d'aspirazione



Suction Tube



EI-051-14
Ø 1.5 mm
14 cm (5 1/2")



EI-053-14
Ø 2.5 mm
14 cm (5 1/2")



EI-055-14
Ø 3.0 mm
14 cm (5 1/2")



EI-057-14
Ø 4.0 mm
14 cm (5 1/2")



EI-059-14
Ø 6.0 mm
14 cm (5 1/2")

EI-051-18
Ø 1.5 mm
18 cm (7")

EI-053-18
Ø 2.5 mm
18 cm (7")

EI-055-18
Ø 3.0 mm
18 cm (7")

EI-057-18
Ø 4.0 mm
18 cm (7")

EI-059-18
Ø 6.0 mm
18 cm (7")



EI-091-20
Adson Suction Tube
12 Charr. Ø 4.0 mm
Overall Length 20 cm (8")



EI-094-24
Frazier Suction Tube
10 Charr. Ø 3.3 mm
Overall Length 24 cm (9 1/2")

Suction Tubes
Sauger
Tubos de aspiración
Tubes d'aspiration
Tubi d'aspirazione



EI-101-06
Ø 2.0 mm
6 Charr.

EI-101-07
Ø 2.3 mm
7 Charr.

EI-101-08
Ø 2.7 mm
8 Charr.

EI-101-09
Ø 3.0 mm
9 Charr.

EI-101-10
Ø 3.3 mm
10 Charr.

EI-101-11
Ø 3.6 mm
11 Charr.

EI-101-12
Ø 4.0 mm
12 Charr.

EI-101-15
Ø 5.0 mm
15 Charr.

Frazier Suction Tube
Overall Length 19.5 cm (7 ¾")



EI-111-05
Ø 1.7 mm
5 Charr.

EI-111-06
Ø 2.0 mm
6 Charr.

EI-111-08
Ø 2.5 mm
8 Charr.

EI-111-09
Ø 3.0 mm
9 Charr.

EI-111-12
Ø 4.0 mm
12 Charr.

EI-111-15
Ø 5.0 mm
15 Charr.

Fergusson Suction Tube
Overall Length 18 cm (7")

Suction Tubes
 Sauger
 Tubos de aspiración
 Tubes d'aspiration
 Tubi d'aspirazione



Working End Size	Overall Length							
	16.5 cm (6 1/2")	18 cm (7")	20.5 cm (8")	21 cm (8 1/4")	22 cm (8 3/4")	23 cm (9")	24 cm (9 1/2")	26.5 cm (10 1/2")
Ø 0.6 mm 2 Fr.	<u>EI-113-02</u>	<u>EI-115-02</u>	<u>EI-117-02</u>	<u>EI-120-02</u>	<u>EI-122-02</u>	<u>EI-119-02</u>	<u>EI-124-02</u>	<u>EI-126-02</u>
Ø 1.0 mm 3 Fr.	<u>EI-113-03</u>	<u>EI-115-03</u>	<u>EI-117-03</u>	<u>EI-120-03</u>	<u>EI-122-03</u>	<u>EI-119-03</u>	<u>EI-124-03</u>	<u>EI-126-03</u>
Ø 1.3 mm 4 Fr.	<u>EI-113-04</u>	<u>EI-115-04</u>	<u>EI-117-04</u>	<u>EI-120-04</u>	<u>EI-122-04</u>	<u>EI-119-04</u>	<u>EI-124-04</u>	<u>EI-126-04</u>
Ø 1.6 mm 5 Fr.	<u>EI-113-05</u>	<u>EI-115-05</u>	<u>EI-117-05</u>	<u>EI-120-05</u>	<u>EI-122-05</u>	<u>EI-119-05</u>	<u>EI-124-05</u>	<u>EI-126-05</u>
Ø 2.0 mm 6 Fr.	<u>EI-113-06</u>	<u>EI-115-06</u>	<u>EI-117-06</u>	<u>EI-120-06</u>	<u>EI-122-06</u>	<u>EI-119-06</u>	<u>EI-124-06</u>	<u>EI-126-06</u>
Ø 2.3 mm 7 Fr.	<u>EI-113-07</u>	<u>EI-115-07</u>	<u>EI-117-07</u>	<u>EI-120-07</u>	<u>EI-122-07</u>	<u>EI-119-07</u>	<u>EI-124-07</u>	<u>EI-126-07</u>
Ø 2.6 mm 8 Fr.	<u>EI-113-08</u>	<u>EI-115-08</u>	<u>EI-117-08</u>	<u>EI-120-08</u>	<u>EI-122-08</u>	<u>EI-119-08</u>	<u>EI-124-08</u>	<u>EI-126-08</u>
Ø 3.0 mm 9 Fr.	<u>EI-113-09</u>	<u>EI-115-09</u>	<u>EI-117-09</u>	<u>EI-120-09</u>	<u>EI-122-09</u>	<u>EI-119-09</u>	<u>EI-124-09</u>	<u>EI-126-09</u>
Ø 3.3 mm 10 Fr.	<u>EI-113-10</u>	<u>EI-115-10</u>	<u>EI-117-10</u>	<u>EI-120-10</u>	<u>EI-122-10</u>	<u>EI-119-10</u>	<u>EI-124-10</u>	<u>EI-126-10</u>
Ø 3.6 mm 11 Fr.	<u>EI-113-11</u>	<u>EI-115-11</u>	<u>EI-117-11</u>	<u>EI-120-11</u>	<u>EI-122-11</u>	<u>EI-119-11</u>	<u>EI-124-11</u>	<u>EI-126-11</u>
Ø 4.0 mm 12 Fr.	<u>EI-113-12</u>	<u>EI-115-12</u>	<u>EI-117-12</u>	<u>EI-120-12</u>	<u>EI-122-12</u>	<u>EI-119-12</u>	<u>EI-124-12</u>	<u>EI-126-12</u>

Fukushima Tear Drop Suction Tube
 Straight, Malleable

Suction Tubes
Sauger
Tubos de aspiración
Tubes d'aspiration
Tubi d'aspirazione



Fukushima Tear Drop Suction Tube
Angled, Semi Rigid

Working End Size	Overall Length		
	21 cm (8 ¼")	23.5 cm (9 ¼")	26 cm (10 ¼")
Ø 0.6 mm 2 Fr.	<u>EI-121-02</u>	<u>EI-1EI-02</u>	<u>EI-125-02</u>
Ø 1.0 mm 3 Fr.	<u>EI-121-03</u>	<u>EI-1EI-03</u>	<u>EI-125-03</u>
Ø 1.3 mm 4 Fr.	<u>EI-121-04</u>	<u>EI-1EI-04</u>	<u>EI-125-04</u>
Ø 1.6 mm 5 Fr.	<u>EI-121-05</u>	<u>EI-1EI-05</u>	<u>EI-125-05</u>
Ø 2.0 mm 6 Fr.	<u>EI-121-06</u>	<u>EI-1EI-06</u>	<u>EI-125-06</u>
Ø 2.3 mm 7 Fr.	<u>EI-121-07</u>	<u>EI-1EI-07</u>	<u>EI-125-07</u>
Ø 2.6 mm 8 Fr.	<u>EI-121-08</u>	<u>EI-1EI-08</u>	<u>EI-125-08</u>
Ø 3.0 mm 9 Fr.	<u>EI-121-09</u>	<u>EI-1EI-09</u>	<u>EI-125-09</u>
Ø 3.3 mm 10 Fr.	<u>EI-121-10</u>	<u>EI-1EI-10</u>	<u>EI-125-10</u>
Ø 3.6 mm 11 Fr.	<u>EI-121-11</u>	<u>EI-1EI-11</u>	<u>EI-125-11</u>
Ø 4.0 mm 12 Fr.	<u>EI-121-12</u>	<u>EI-1EI-12</u>	<u>EI-125-12</u>

Suction Tubes
Sauger
Tubos de aspiración
Tubes d'aspiration
Tubi d'aspirazione

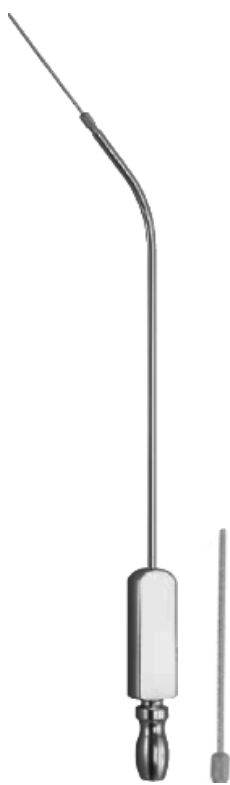

Zoellner Suction Tube Complete

- EI-131-00**
Complete With Suction Tips
- EI-131-01**
Suction Handle Only
- EI-132-05**
Ø 0.5 mm
- EI-132-07**
Ø 0.7 mm
- EI-132-09**
Ø 0.9 mm
- EI-132-12**
Ø 1.2 mm



Plester Suction Tube
With Grip Plate, Cut off Hole and Stylet
Overall Length 20 cm (8")

- EI-135-05**
Ø 1.7 mm
5 Charr.
- EI-135-06**
Ø 2.0 mm
6 Charr.
- EI-135-07**
Ø 2.3 mm
7 Charr.
- EI-135-08**
Ø 2.6 mm
8 Charr.
- EI-135-09**
Ø 3.0 mm
9 Charr.



EI-141-00
Wullstein Suction Tube Complete
With Suction Handle and Micro
Suction Tube Ref: EI-142-04,
EI-142-06, EI-142-08
Overall Length 14 cm (5 1/2")



EI-141-01
Wullstein Suction Tube Only
Overall Length 14 cm (5 1/2")



- EI-142-04**
Ø 0.4 mm
 - EI-142-06**
Ø 0.6 mm
 - EI-142-08**
Ø 0.8 mm
- Wullstein Micro Suction Handle**
Overall Length 4.5 cm (1 3/4")

Suction Tubes
Sauger
Tubos de aspiración
Tubes d'aspiration
Tubi d'aspirazione



- EI-151-10**
Ø 75 mm, 1.0 mm
- EI-151-10**
Ø 75 mm, 1.5 mm
- EI-151-10**
Ø 75 mm, 2.0 mm

Baron-Schuknecht Suction Handle
With Finger Cut Off



EI-180-00
House Suction Adapter
With Finger Cut Off



- EI-185-05**
Ø 0.5 mm
- EI-185-07**
Ø 0.5 mm
- EI-185-10**
Ø 0.5 mm
- EI-185-12**
Ø 0.5 mm
- EI-185-15**
Ø 1.5 mm

Verhoeven Suction Cannula
With Luer Cone



- EI-191-09**
Ø 0.9 mm, 0.7 mm
- EI-191-12**
Ø 1.2 mm, 0.9 mm
- EI-191-15**
Ø 1.5 mm, 1.2 mm

House Suction Tube
With Finger Cut Off



- EI-201-30**
Ø 110 mm, 3.0 mm
- EI-201-35**
Ø 110 mm, 3.5 mm
- EI-201-45**
Ø 110 mm, 4.5 mm

Luer Suction Tube

Suction Tubes
 Sauger
 Tubos de aspiración
 Tubes d'aspiration
 Tubi d'aspirazione

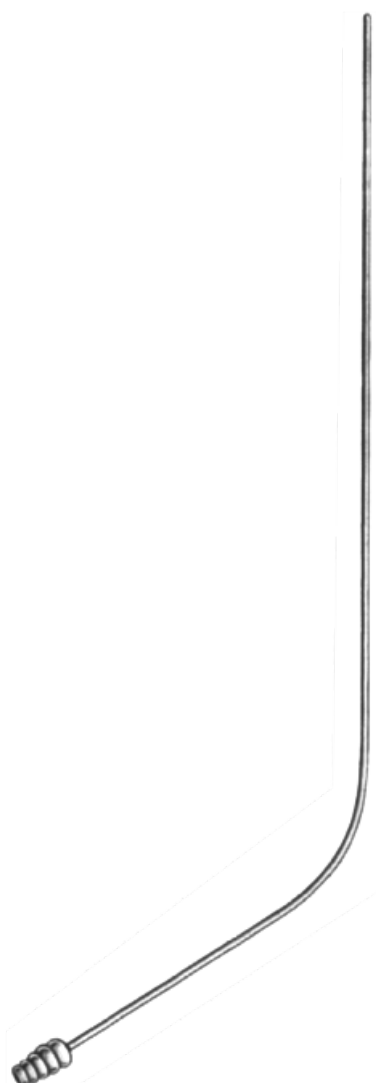

Yasargil Suction Tube
 With Luer Hub

<u>EI-221-15</u> Ø 130 mm, 1.5 mm	<u>EI-221-20</u> Ø 130 mm, 2.0 mm	<u>EI-221-25</u> Ø 130 mm, 2.5 mm	<u>EI-221-35</u> Ø 130 mm, 3.5 mm
<u>EI-2EI-15</u> Ø 150 mm, 1.5 mm	<u>EI-2EI-20</u> Ø 150 mm, 2.0 mm	<u>EI-2EI-25</u> Ø 150 mm, 2.5 mm	<u>EI-2EI-35</u> Ø 150 mm, 3.5 mm
<u>EI-225-15</u> Ø 180 mm, 1.5 mm	<u>EI-225-20</u> Ø 180 mm, 2.0 mm	<u>EI-225-25</u> Ø 180 mm, 2.5 mm	<u>EI-225-35</u> Ø 180 mm, 3.5 mm
<u>EI-227-15</u> Ø 220 mm, 1.5 mm	<u>EI-227-20</u> Ø 220 mm, 2.0 mm	<u>EI-227-25</u> Ø 220 mm, 2.5 mm	<u>EI-227-35</u> Ø 220 mm, 3.5 mm

Suction Tubes
Sauger
Tubos de aspiración
Tubes d'aspiration
Tubi d'aspirazione



EI-241-04
4.0 mm

EI-241-05
5.0 mm

Suction Raspatory
Sharp, Bayonet Shaped
Overall Length 20 cm (8")



EI-243-32
Landolt Dissecting Suction Tube
Sharp, 3.2 mm
Overall Length 20 cm (8")



EI-245-23
Andrews-Pynchon Suction Tube (Complete)
Ø 2.0 mm
Overall Length 23 cm (9")



EI-247-01
Ø 3.0 mm
21 cm (8 1/4")

EI-247-02
Ø 4.0 mm
22.5 cm (8 3/4")

EI-247-03
Ø 4.0 mm
24.5 cm (9 1/2")

Morse-Andrews Suction Tube

Suction Tubes
Sauger
Tubos de aspiración
Tubes d'aspiration
Tubi d'aspirazione



EI-251-27
Yankauer Suction Tube (Complete)
Central Bore, 2.0 mm
Overall Length 31 cm (12 1/4")



EI-251-27 FO
Yankauer Suction Tube (With Fiber Optic Carrier Complete)
Central Bore, 2.0 mm
Overall Length 31 cm (12 1/4")



EI-253-27
Yankauer Suction Tube (Complete)
Central Bore, 4.8 mm
Overall Length 31 cm (12 1/4")

Suction Tubes
Sauger
Tubos de aspiración
Tubes d'aspiration
Tubi d'aspirazione



EI-255-00
Yankauer Suction Tube Complete (Detachable)
With Handle, 4 Tube, Suction Tip and Tube Connector
Overall Length 31 cm (21 1/4")



EI-255-01
Yankauer Suction Handle Only
Overall Length 15 cm (6")



EI-255-02
Yankauer Suction Connector Only
Oval Shaped
Overall Length 2.5 cm (1")



EI-255-10
Yankauer Suction Tube
Fig. 0
Overall Length 10 cm (4")



EI-255-11
Yankauer Suction Tube
Fig. 1
Overall Length 10 cm (4")



EI-255-12
Yankauer Suction Tube
Fig. 2
Overall Length 10 cm (4")

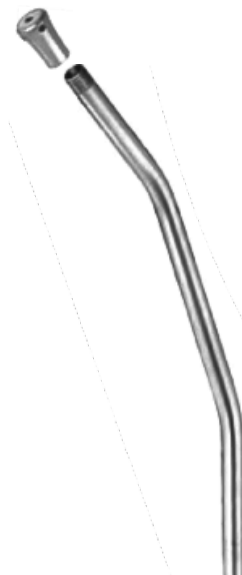

EI-255-13
Yankauer Suction Tube
Fig. 3
Overall Length 13.5 cm (5 1/4")



EI-255-15
Yankauer Suction Tip

Suction Tubes
 Sauger
 Tubos de aspiración
 Tubes d'aspiration
 Tubi d'aspirazione



EI-270-22
Poole Suction Tube
 Ø 10.0 mm
 Overall Length 22 cm (8 ¾")



EI-271-22
Poole Suction Tube
 Ø 8.0 mm
 Overall Length 22.5 cm (8 ¾")



EI-2EI-20
Poole-Baby Suction Tube
 Ø 5.5 mm
 Overall Length 22 cm (8")



EI-281-35
Cooley Suction Tube
 Ø 8.0 mm
 Overall Length 36 cm (14 ¼")

Suction Tubes
Sauger
Tubos de aspiración
Tubes d'aspiration
Tubi d'aspirazione



EI-283-31
Cooley Suction Tube
Ø 10.0 mm
With Perforated Screw Tip
Overall Length 31 cm (12 ¼")



EI-285-30
Cooley Suction Tube
Ø 7.0 mm
With Perforated Screw Tip
Overall Length 31 cm (12 ¼")



EI-2EI-33
Cooley Suction Tube
Ø 8.0 mm
With Perforated Screw Tip
Overall Length 36 cm (12 ¼")



EI-291-27
DeBaKey Suction Tube
Ø 9.0 mm
Overall Length 27.5 cm (12 ¼")



EI-293-16
Ø 5.0 mm, Ø 9.0 mm
16 cm (6 ¼")

DeBaKey Suction Tube

EI-293-27
Ø 5.0 mm, Ø 9.0 mm
27 cm (10 ¾")



EI-301-32
Finsterer Suction Tube
Ø 15.0 mm
Overall Length 32 cm (12 ¾")

Suction Tubes
Sauger
Tubos de aspiración
Tubes d'aspiration
Tubi d'aspirazione



EI-311-21
Nuboer Suction Tube
Round Opening, Ø 6.0 mm
Overall Length 21 cm (8 1/4")



EI-313-21
Nuboer Suction Tube
Oval Opening, Ø 6.0 mm
Overall Length 21 cm (8 1/4")

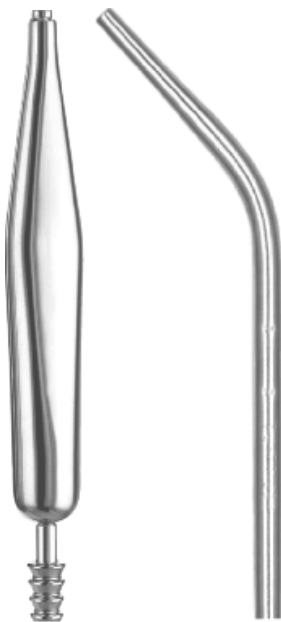

EI-321-00
Coupland Suction Tube Complete
With Suction Tips Ref: EI-3EI-05 to EI-3EI-08



EI-322-24
Nuboer Suction Tube
With Tube Connector
Overall Length 17 cm (6 3/4")



- EI-3EI-05**
Ø 1.5 mm
- EI-3EI-06**
Ø 2.0 mm
- EI-3EI-07**
Ø 2.5 mm
- EI-3EI-08**
Ø 3.5 mm

Coupland Suction Tip
Laterally Perforated
Overall Length 9 cm (3 1/2")

Suction Tubes, Special Needles
 Sauger, Spezialkanülen
 Tubos de aspiración, Aguja especiales
 Tubes d'aspiration, Aiguilles spéciales
 Tubi d'aspirazione, Aghi speciali



- EI-341-30**
Ø 3.0 mm
- EI-341-38**
Ø 2.5 mm
- EI-341-43**
Ø 3.5 mm

Byrd Suction Tube
 Overall Length 21.5 cm (8 1/2")



EI-345-23
Cogswell Suction Tube
 With Finger Cutt Off
 Overall Length 24.5 cm (9 3/4")



EI-400-00
Hypodermic Needle
 Set of 7 Ref: EI-602-01 Up
 to EI-602-20
 Overall Length 24.5 cm (9 3/4")



Hypodermic Needle

EI-400-01

Fig. 1
 0.85 x 40 mm

EI-400-02

Fig. 2
 0.80 x 35 mm

EI-400-12

Fig. 12
 0.70 x 32 mm

EI-400-14

Fig. 14
 0.65 x 30 mm

EI-400-16

Fig. 16
 0.60 x 25 mm

EI-400-18

Fig. 18
 0.50 x 23 mm

EI-400-20

Fig. 20
 0.45 x 18 mm

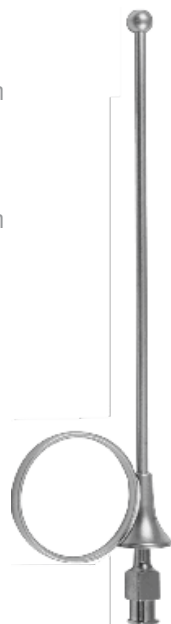

EI-410-00
Pudendus Anaesthesia Needle
 Ø 1.0 x 185 mm
 Complete With Cannula
 Overall Length 18 cm (7")



EI-420-12
 Ø 1.2 x 80 mm

EI-420-15
 Ø 1.5 x 80 mm

Vein Cannula
 Button End, With Tube Connector

Special Needles
Spezialkanülen
Agujas especiales
Aiguilles spéciales
Aghi speciali

Special Needles
Spezialkanülen
Agujas especiales
Aiguilles spéciales
Aghi speciali

EI-450-10
Ø 1.2 x 76 mm

EI-450-12
Ø 1.2 x 89 mm

EI-450-14
Ø 1.0 x 76 mm

EI-450-16
Ø 1.0 x 89 mm

EI-450-18
Ø 0.7 x 76 mm

EI-450-19
Ø 0.7 x 50 mm

EI-450-20
Ø 0.7 x 89 mm



Quinke Lumbar Puncture Needle
18 G, 19 G, 22 G, With Luer Lock Connection



Tuohy Lumbar Puncture Needle
18 G, 17 G, 16 G, With Luer Lock Connection, Special Tip

EI-460-12
Ø 1.2 x 76 mm

EI-460-14
Ø 1.4 x 76 mm

EI-460-16
Ø 1.4 x 35 mm



EI-464-13
Abrams Pleural Biopsy Needle Set
Ø 4.0 mm
Overall Length 13.5 cm (5 1/2")



Menghini Liver Puncture Needle
Blind Lever Puncture, With Stopping Needle

EI-470-10
Ø 1.0 x 35 mm

EI-470-25
Ø 1.2 x 100 mm

EI-470-40
Ø 1.6 x 70 mm

EI-470-15
Ø 1.0 x 70 mm

EI-470-30
Ø 1.4 x 70 mm

EI-470-50
Ø 1.8 x 100 mm

EI-470-20
Ø 1.2 x 70 mm

EI-470-35
Ø 1.4 x 100 mm



Special Needles
Spezialkanülen
Agujas especiales
Aiguilles spéciales
Aghi speciali



EI-472-14
Ø 1.0 x 35 mm

EI-472-18
Ø 1.8 x 168 mm

Menghini Liver Puncture Needle
For Controlled Blind Liver Puncture



EI-480-15
Ø 1.5 x 90 mm

EI-480-18
Ø 1.8 x 90 mm

EI-480-20
Ø 2.0 x 90 mm

Lichtwitz Antrum Puncture Needle



EI-490-10
Tonsil Needle
Ø 0.65 mm
Tapered Tip With Luer Lock Connection



EI-491-15
Tonsil Needle
Ø 0.65 mm
Tapered Tip With Luer Lock Connection



EI-493-20
Tonsil Needle
Ø 0.65 mm
Tapered Tip With Luer Lock Connection

Vessel Irrigation Cannulas
 Gefäß-Spülkanülen
 Cánulas para irrigación vascular
 Canules pour irrigation vasculaire
 Cannule per irrigazione vascolare



EI-500-20
Verres Insufflation Cannula
 With Luer Lock Connection
 Ø 2.0 x 100 mm



EI-502-20
Verres Insufflation Cannula
 With Luer Lock Connection
 Ø 2.0 x 120 mm



EI-520-15 Ø 1.5 mm	EI-520-20 Ø 2.0 mm
EI-520-25 Ø 2.5 mm	EI-520-30 Ø 3.0 mm
EI-520-40 Ø 4.0 mm	

Vollmar Vessel Irrigation Cannula
 With Luer Lock Connection
 Overall Length 6 cm (2 ¼")



Schmid Vessel Irrigation Cannula
 Malleable, With Luer Lock Connection
 Overall Length 15 cm (6")



EI-530-03
 Ø 3.0 mm

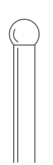

EI-530-04
 Ø 4.0 mm



EI-530-05
 Ø 5.0 mm



EI-530-06
 Ø 6.0 mm



EI-5EI-30
Abraham Laryngeal Cannula
 Malleable, With Luer Lock Connection
 Ø 3.0 mm
 Overall Length 15 cm (6")

Special Needles, Suction Cannulas
Spezialkanülen, Saugrohre
Agujas especiales, Tubos de aspiración
Aiguilles spéciales, Tubes d'aspiration
Aghi speciali, Tubi d'aspirazione



EI-548-05
DeBakey Heparin Cannula
With Luer Lock Connection
Ø 5.0 mm
Overall Length 16 cm (6 1/4")



EI-550-08
Ø 2.9 mm x
0.8 mm

EI-550-10
Ø 2.9 mm x
0.8 mm

Mock Heparin Flushing Needle
Button End With Luer Lock
Connection
Overall Length 6.5 cm (2 1/2")



EI-552-09
Frazier Ventricular Cannula
Graduated in centimeters
Ø 2.6 mm
Overall Length 9 cm (3 1/2")



EI-554-12
With 1 Hole
Ø 1.2 mm

EI-554-16
With 1 Hole
Ø 1.6 mm

EI-554-12
With 2 Hole
Ø 1.2 mm

EI-554-16
With 2 Hole
Ø 1.6 mm

Frazier Ventricular Cannula
Overall Length 9 cm (3 1/2")

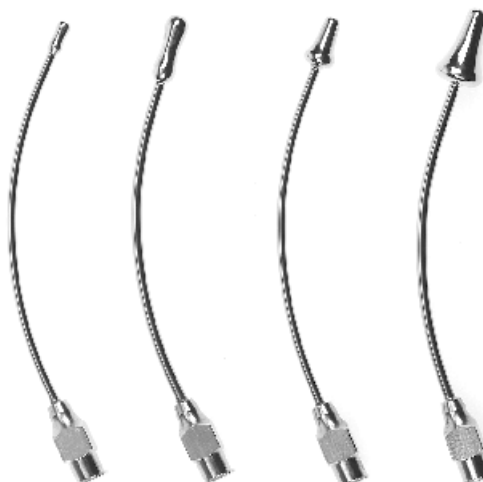

EI-560-00
Tibbs Arterial Cannula Set



Hypodermic Syringe
 Gefäßclips, Approximatoren
 Clips vasculares, Aproximadores
 Clips vasculaires, Approximateurs
 Clip vascolari, Approssimatori



EI-600-02
2.0 ml

EI-600-05
5.0 ml

EI-600-10
10.0 ml

3 Ring Hypodermic Syringe
 Glass Barrel, With Luer Lock
 Connection, Moveable Rings



EI-610-05
50 ml

EI-610-10
100 ml

EI-610-05
150 ml

EI-610-05
200 ml

Janet Wound and Bladder Syringe
 Glass Barrel, With 2 Exchangeable Tips

Guide Needles
 Führungsnadeln
 Agujas de guía
 Aiguilles d'introduction
 Aghi conduttori



- EI-701-08**
2.7 mm - 8 Charr.
- EI-701-12**
4.0 mm - 12 Charr.
- EI-701-16**
5.3 mm - 16 Charr.

Redon Guide Needle
 Knife Tip
 Overall Length 19.5 cm (7 3/4")

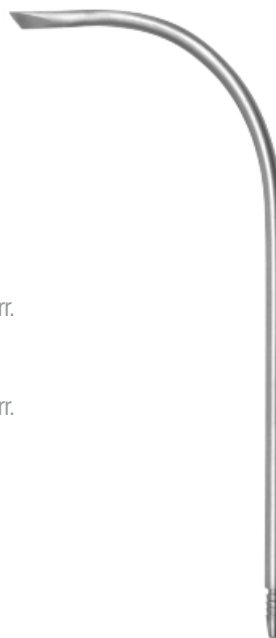

- EI-701-10**
3.3 mm - 10 Charr.
- EI-701-14**
4.7 mm - 14 Charr.
- EI-701-18**
6 mm - 18 Charr.

Redon Guide Needle
 Knife Tip
 Overall Length 19.5 cm (7 3/4")

- EI-703-08**
2.7 mm - 8 Charr.
- EI-703-12**
4.0 mm - 12 Charr.
- EI-703-16**
5.3 mm - 16 Charr.
- EI-703-10**
3.3 mm - 10 Charr.
- EI-703-14**
4.7 mm - 14 Charr.
- EI-703-18**
6 mm - 18 Charr.



- EI-705-08**
2.7 mm - 8 Charr.
- EI-705-12**
4.0 mm - 12 Charr.
- EI-705-16**
5.3 mm - 16 Charr.

Redon Guide Needle
 Lancet Tip
 Overall Length 19.5 cm (7 3/4")



- EI-707-08**
2.7 mm - 8 Charr.
- EI-707-12**
4.0 mm - 12 Charr.
- EI-707-16**
5.3 mm - 16 Charr.
- EI-707-10**
3.3 mm - 10 Charr.
- EI-707-14**
4.7 mm - 14 Charr.
- EI-707-18**
6 mm - 18 Charr.

Redon Guide Needle
 Trocar Tip
 Overall Length 19.5 cm (7 3/4")

Catheter Introducing Forceps
Kathetereinführzangen
Pinzas para catéteres
Pincés pour introduire les sondes
Pinze per introdurre le sonde



Magill Catheter Introducing Forcep

EI-010-15
For Babies
14.5 cm (5 ¾")

EI-010-20
For Children
20 cm (8")

EI-010-25
For Adults
25 cm (9 ¾")

Laryngoscopes and Accessories
Laryngoskope und Zubehör
Laringoscopios y accesorios
Laryngoscopes et accessoires
Laringoscopi ed accessori

EVA

ANAESTHESIA



Apollo™ Standard Miller-Baby Laryngoscope Set

EI-100-00

With Battery Handle
Ref: EI-290-01 and
2 Blades Ref: EI-110-00
to EI-110-01

EI-101-00

With Battery Handle
Ref: EI-290-01 and
3 Blades Ref: EI-110-01
to EI-110-03

EI-102-00

With Battery Handle
Ref: EI-290-01 and
4 Blades Ref: EI-110-01
to EI-110-04

EI-103-00

With Battery Handle
Ref: EI-290-01 and
5 Blades Ref: EI-110-00
to EI-110-04



EI-110-00

Fig. 0
55 mm, For Babies

EI-110-01

Fig. 1
80 mm, For Children

EI-110-02

Fig. 2
130 mm, Adolescents

EI-110-03

Fig. 3
170 mm, For Women

EI-110-04

Fig. 4
180 mm, For Men

Apollo™ Standard Miller Laryngoscope Blade

Laryngoscopes and Accessories
Laryngoskope und Zubehör
Laringoscopios y accesorios
Laryngoscopes et accessoires
Laringoscopi ed accessori



Apollo™ Standard McIntosh-Baby Laryngoscope Set



- EI-210-00**
Fig. 0
55 mm, For Babies
- EI-210-01**
Fig. 1
75 mm, For Children
- EI-210-02**
Fig. 2
90 mm, Adolescents
- EI-210-03**
Fig. 3
110 mm, For Women
- EI-210-04**
Fig. 4
135 mm, For Men

Apollo™ Standard Miller Laryngoscope Blade



EI-290-01
Apollo™ Standard Battery Handle
Chrome Plated



- EI-294-01**
For Blades Fig. 2 to 4
- EI-294-02**
For Blades Fig. 0 to 1

Apollo™ Standard Spare Bulb Large



Laryngoscopes and Accessories
Laryngoskope und Zubehör
Laringoscopios y accesorios
Laryngoscopes et accessoires
Laringoscopi ed accessori

EVA

ANAESTHESIA



EI-400-00
With Battery Handle
Ref: EI-590-01 and
2 Blades Ref: EI-410-00
to EI-410-01

EI-402-00
With Battery Handle
Ref: EI-590-01 and
4 Blades Ref: EI-410-01
to EI-410-04

EI-401-00
With Battery Handle
Ref: EI-590-01 and
3 Blades Ref: EI-410-01
to EI-410-03

EI-403-00
With Battery Handle
Ref: EI-590-01 and
5 Blades Ref: EI-410-00
to EI-410-04

Corona™ Premium Fibre Optic McIntosh-Baby Laryngoscope Set



EI-410-00
Fig. 0
55 mm, For Babies

EI-410-01
Fig. 1
70 mm, For Children

EI-410-02
Fig. 2
80 mm, Adolescents

EI-410-03
Fig. 3
105 mm, For Women

EI-410-04
Fig. 4
130 mm, For Men

Corona™ Premium Fibre Optic McIntosh Laryngoscope Blade



Laryngoscopes and Accessories
Laryngoskope und Zubehör
Laringoscopios y accesorios
Laryngoscopes et accessoires
Laringoscopi ed accessori



Corona™ Premium Fibre Optic Miller-Baby Laryngoscope Set



EI-510-00

Fig. 0
55 mm, For Babies

EI-510-01

Fig. 1
80 mm, For Children

EI-510-02

Fig. 2
130 mm, Adolescents

EI-510-03

Fig. 3
170 mm, For Women

EI-510-04

Fig. 4
180 mm, For Men

Corona™ Premium Fibre Optic McIntosh Laryngoscope Blade



EI-500-00

With Battery Handle
Ref: EI-590-01 and
2 Blades Ref: EI-510-00
to EI-510-01

EI-501-00

With Battery Handle
Ref: EI-590-01 and
3 Blades Ref: EI-510-01
to EI-510-03

EI-502-00

With Battery Handle
Ref: EI-590-01 and
4 Blades Ref: EI-410-01
to EI-410-04

EI-503-00

With Battery Handle
Ref: EI-590-01 and
5 Blades Ref: EI-510-00
to EI-510-04

Laryngoscopes and Accessories
Laryngoskope und Zubehör
Laringoscopios y accesorios
Laryngoscopes et accessoires
Laringoscopi ed accessori

EVA

ANAESTHESIA



EI-590-01
Corona™ Premium Fibre Optic Battery Handle
With 2.5 Volts Xenon Bulb



EI-592-02
Corona™ Premium Fibre Optic Battery Handle
Slim Profile, With 2.5 Volts Xenon Bulb



EI-594-01
Corona™ Premium Fibre Optic Spare Bulb
Xenon, 2.5 V



Laryngoscopes and Accessories
Laryngoskope und Zubehör
Laringoscopios y accesorios
Laryngoscopes et accessoires
Laringoscopi ed accessori



EI-700-00

With Battery Handle
Ref: EI-890-01 and
2 Blades Ref: EI-710-00
to EI-710-01

EI-702-00

With Battery Handle
Ref: EI-890-01 and
4 Blades Ref: EI-710-01
to EI-710-04

EI-701-00

With Battery Handle
Ref: EI-890-01 and
3 Blades Ref: EI-710-01
to EI-710-03

EI-703-00

With Battery Handle
Ref: EI-890-01 and
5 Blades Ref: EI-710-00
to EI-710-04

MaxBright™ LED Fibre Optic McIntosh-Baby Laryngoscope Set



EI-710-00

Fig. 0
55 mm, For Babies

EI-710-01

Fig. 1
70 mm, For Children

EI-710-02

Fig. 2
80 mm, Adolescents

EI-710-03

Fig. 3
105 mm, For Women

EI-710-04

Fig. 4
130 mm, For Men

MaxBright™ LED Fibre Optic McIntosh Laryngoscope Blade



Laryngoscopes and Accessories
Laryngoskope und Zubehör
Laringoscopios y accesorios
Laryngoscopes et accessoires
Laringoscopi ed accessori

ANAESTHESIA



MaxBright™ Fibre Optic Miller-Baby Laryngoscope Set

EI-800-00

With Battery Handle
Ref: EI-890-01 and
2 Blades Ref: EI-810-00
to EI-810-01

EI-802-00

With Battery Handle
Ref: EI-890-01 and
4 Blades Ref: EI-810-01
to EI-810-04

EI-801-00

With Battery Handle
Ref: EI-890-01 and
3 Blades Ref: EI-810-01
to EI-810-03

EI-803-00

With Battery Handle
Ref: EI-890-01 and
5 Blades Ref: EI-810-00
to EI-810-04



EI-810-00

Fig. 0
55 mm, For Babies

EI-810-01

Fig. 1
80 mm, For Children

EI-810-02

Fig. 2
130 mm, Adolescents

EI-810-03

Fig. 3
170 mm, For Women

EI-810-04

Fig. 4
180 mm, For Men

MaxBright™ LED Fibre Optic McIntosh Laryngoscope Blade



Laryngoscopes and Accessories
Laryngoskope und Zubehör
Laringoscopios y accesorios
Laryngoscopes et accessoires
Laringoscopi ed accessori



EI-890-01
MaxBright™ Fibre Optic Battery Handle
With 2.5 Volts LED Bulb



EI-892-02
MaxBright™ Fibre Optic Battery Handle
Slim Profile, With 2.5 Volts LED Bulb



EI-894-01
MaxBright™ LED Fibre Optic Spare Bulb
Xenon, 2.5 V



Needle Holders
Nadelhalter
Porta-agujas
Porte-aiguilles
Portaghi



EI-010-12
Dorf Needle Holder
One Fenestrated Jaw
Overall Length 12 cm (4 3/4")



EI-012-12
Converse Needle Holder
Jaw With Longitudinal Serrations
Overall Length 13 cm (5")



EI-016-12
Collier Needle Holder
One Grooved Jaws
Overall Length 12.5 cm (5")



EI-020-13
Webster Needle Holder
Smooth Jaws
Overall Length 13 cm (5")

Needle Holders
Nadelhalter
Porta-agujas
Porte-aiguilles
Portaghi



EI-024-13
Smooth Jaws

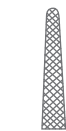

EI-0EI-13
Serrated Jaws



EI-029-13
Kilner Needle Holder
Overall Length 13.5 cm (5 1/4")

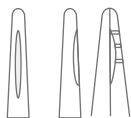

EI-032-13
Neivert Needle Holder
Smooth Jaws With Special Groove
Overall Length 12.5 cm (5")

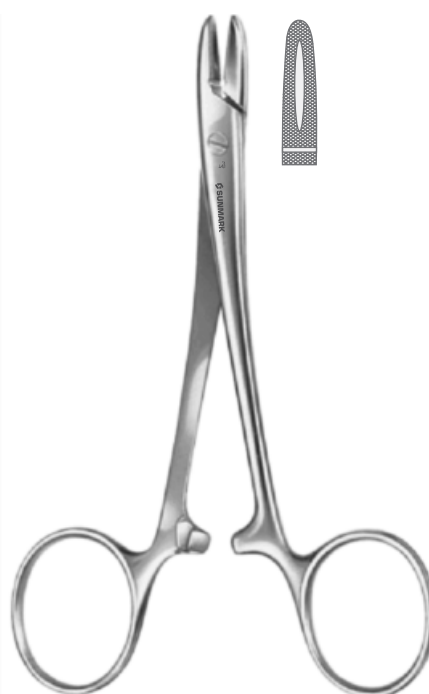

EI-034-13
Doyen Needle Holder
Overall Length 12.5 cm (5")

Needle Holders
Nadelhalter
Porta-agujas
Porte-aiguilles
Portaghi



EI-038-14
Hegar-Baumgartner Needle Holder
Overall Length 14.5 cm (5 ¾")

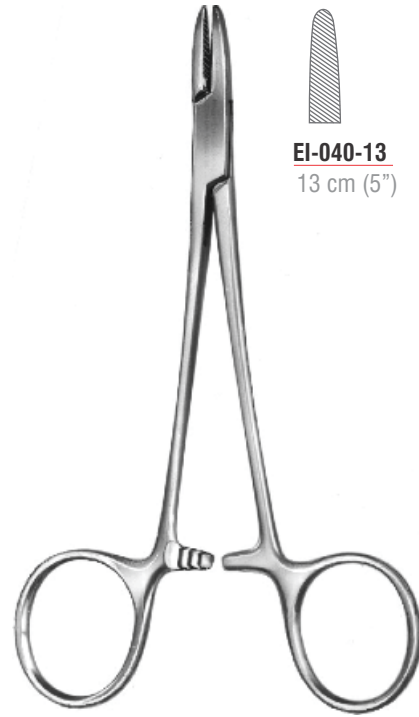

EI-040-13
13 cm (5")

EI-040-18
18 cm (7")

Brown Needle Holder
Heavy Pattern



EI-042-15
Lawrence Needle Holder
Overall Length 14.5 cm (5 ¾")



EI-046-15
Crile-Murray Needle Holder
Slender Pattern
Overall Length 15 cm (6")

Needle Holders
Nadelhalter
Porta-agujas
Porte-aiguilles
Portaghi



Crile-Wood Needle Holder

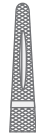

EI-050-15
15 cm (6")

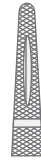

EI-050-18
18 cm (7")

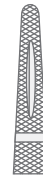

EI-050-20
20 cm (8")



EI-052-18
Adson Needle Holder
One Fenestrated Jaw
Overall Length 18 cm (7")

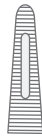

EI-054-18
Metzenbaum Needle Holder
One Grooved and Fenestrated Jaws
Overall Length 18.5 cm (7 1/4")

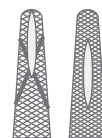

Needle Holders
Nadelhalter
Porta-agujas
Porte-aiguilles
Portaghi



EI-056-17
M.G. Hospital Needle Holder
Heavy Pattern
Overall Length 17.5 cm (7")

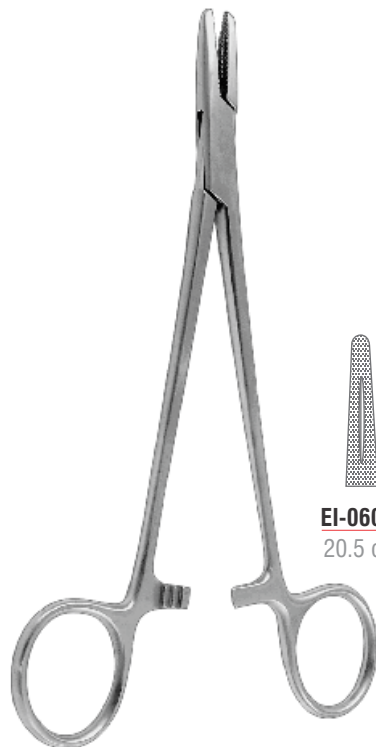

Mayo-Hegar Needle Holder



EI-060-14
14.5 cm (5 3/4")



EI-060-16
16 cm (6 1/4")



EI-060-18
18.5 cm (7 1/4")

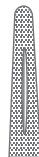

EI-060-20
20.5 cm (8")



EI-060-24
24 cm (9 1/2")



EI-060-26
26.5 cm (10 1/2")



EI-060-30
30.5 cm (12")

Needle Holders
Nadelhalter
Porta-agujas
Porte-aiguilles
Portaghi



Mayo-Hegar (Delicate) Needle Holder
Slender Pattern



EI-062-16
16 cm (6 1/4")

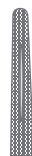

EI-062-18
18.5 cm (7 1/4")



EI-062-20
20.5 cm (8")



Sarot Needle Holder

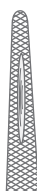

EI-068-18
18 cm (7")



EI-068-26
25.5 cm (10")

Needle Holders
Nadelhalter
Porta-agujas
Porte-aiguilles
Portaghi



EI-070-21
Heaney Needle Holder
Overall Length 20.5 cm (8")



EI-072-23
Jameson Needle Holder
Overall Length 23.5 cm (9 1/4")

Needle Holders
Nadelhalter
Porta-agujas
Porte-aiguilles
Portaghi



EI-0EI-27
Masson Needle Holder
Overall Length 26.5 cm (10 1/2")



EI-077-26
Masson-Luethy Needle Holder
Overall Length 25.5 cm (10")

Needle Holders
Nadelhalter
Porta-agujas
Porte-aiguilles
Portaghi



EI-079-27
Finochietto Needle Holder
Overall Length 26.5 cm (10 1/2")



EI-082-27
Wangensteen Needle Holder
Overall Length 26.5 cm (10 1/2")



EI-085-27
Johnson Needle Holder
Overall Length 27 cm (10 3/4")

Needle Holders
Nadelhalter
Porta-agujas
Porte-aiguilles
Portaghi



Stratte Needle Holder

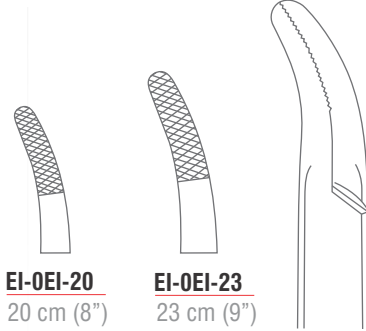

EI-0EI-20
20 cm (8")

EI-0EI-23
23 cm (9")



Olsen-Hegar Needle Holder

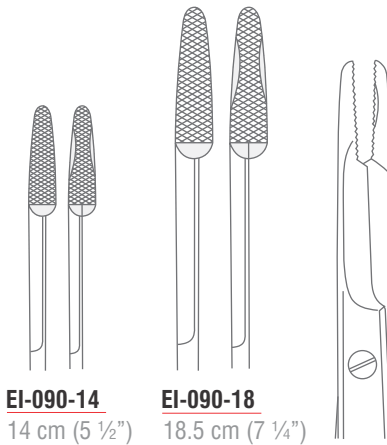

EI-090-14
14 cm (5 1/2")

EI-090-18
18.5 cm (7 1/4")

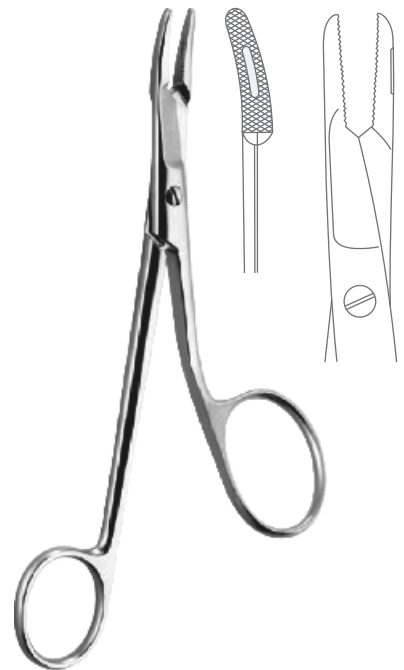

EI-094-16
Gillies Needle Holder
Overall Length 16 cm (6 1/4")

Needle Holders
Nadelhalter
Porta-agujas
Porte-aiguilles
Portaghi



- EI-100-14**
14 cm (5 1/2")
- EI-100-17**
17 cm (6 3/4")
- EI-100-20**
20 cm (8")

Mathieu Needle Holder



- EI-102-14**
14 cm (5 1/2")
- EI-102-17**
16.5 cm (6 1/2")

Mathieu (Delicate) Needle Holder



- EI-110-20**
14 cm (5 1/2")
- EI-110-25**
16.5 cm (6 1/2")

Lichtenberg Needle Holder



- EI-120-20**
20 cm (8")
- EI-120-23**
23 cm (9")

Zweifel Needle Holder

Needle Holders
Nadelhalter
Porta-agujas
Porte-aiguilles
Portaghi



EI-124-25
Hoesel Needle Holder
Overall Length 25 cm (9 3/4")



EI-130-15
Crile Needle Holder
Overall Length 15 cm (6")



EI-134-18
Toennis Needle Holder
Overall Length 18.5 cm (7 1/4")

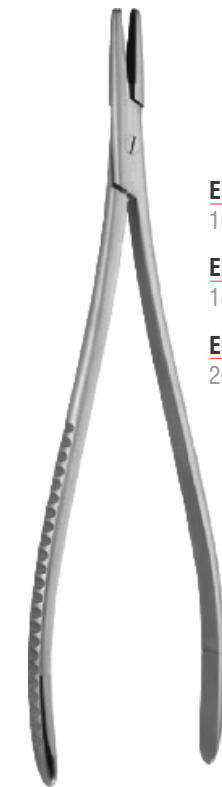

Langenbeck Needle Holder

EI-140-16
16 cm (6 1/4")

EI-140-18
18 cm (7")

EI-140-20
20 cm (8")

Micro Needle Holders
Mikro-Nadelhalter
Micro Porta-agujas
Micro porte-aiguilles
Micro Portaghi



EI-200-10
Straight

EI-201-10
Curved



EI-202-10
Straight

EI-203-10
Curved

McPherson Micro Needle Holder
Very Delicate, Without Lock
Overall Length 10 cm (4")

McPherson Micro Needle Holder
Very Delicate, With Lock
Overall Length 10 cm (4")



EI-210-14
Straight

EI-211-14
Curved



EI-212-14
Straight

EI-213-14
Curved

Castroviejo Micro Needle Holder
Delicate 1.0 x 12 mm Tips, Without Lock
Overall Length 14 cm (5 1/2")

Castroviejo Micro Needle Holder
Delicate 1.0 x 12 mm Tips, With Lock
Overall Length 14 cm (5 1/2")

Micro Needle Holders
Mikro-Nadelhalter
Micro Porta-agujas
Micro porte-aiguilles
Micro Portaghi

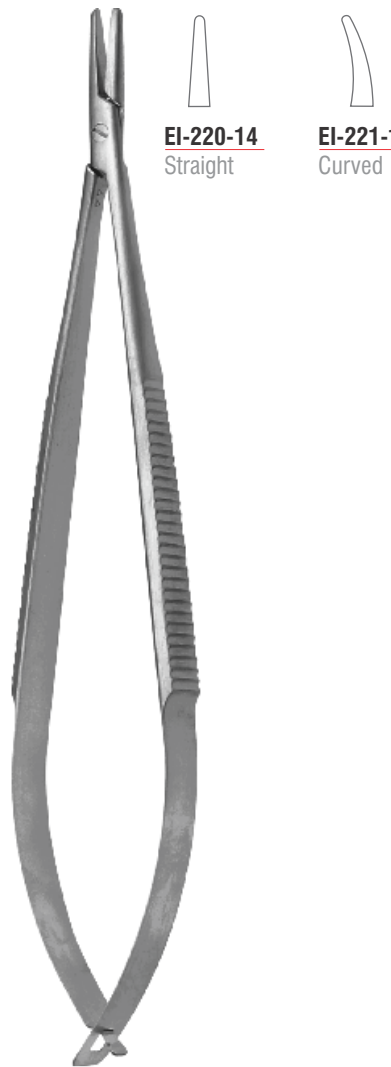

EI-220-14
Straight

EI-221-14
Curved

Castroviejo Micro Needle Holder
Standard 1.5 x 12 mm Tips, Without Lock
Overall Length 14 cm (5 1/2")



EI-222-14
Straight

EI-223-14
Curved

Castroviejo Micro Needle Holder
Standard 1.5 x 12 mm Tips, With Lock
Overall Length 14 cm (5 1/2")

Micro Needle Holders
Mikro-Nadelhalter
Micro Porta-agujas
Micro porte-aiguilles
Micro Portaghi

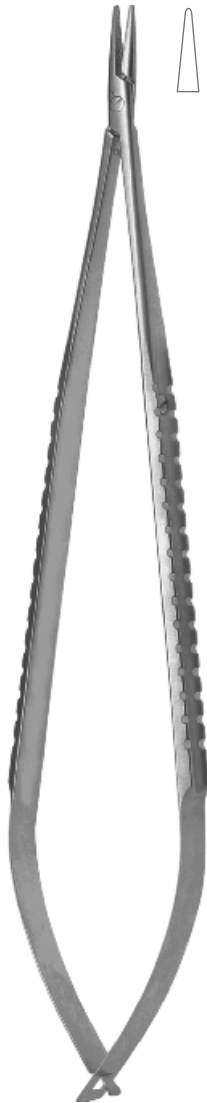

EI-230-18
Jacobson Micro Needle Holder
Straight, Without Lock
Overall Length 18.5 cm (7 1/4")



EI-231-18
Jacobson Micro Needle Holder
Straight, With Lock
Overall Length 18.5 cm (7 1/4")



EI-234-21
Micro Needle Holder
Straight, With Lock
Overall Length 21 cm (8 1/4")

Micro Needle Holders
Mikro-Nadelhalter
Micro Porta-agujas
Micro porte-aiguilles
Micro Portaghi



Yasargil Micro Needle Holder
Bayonet Shaped
Overall Length 16 cm (6 1/4")



EI-238-16
Straight



EI-239-16
Curved



EI-246-14
Kalt Micro Needle Holder
Straight, With Lock
Overall Length 13.5 cm (5 1/4")

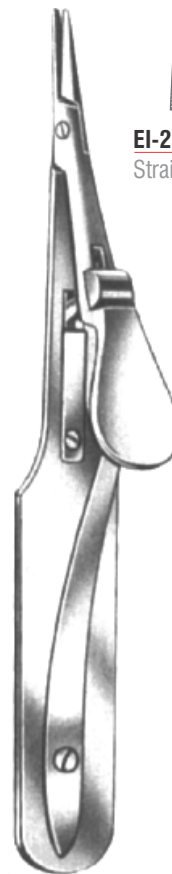

Arruga Micro Needle Holder
With Lock
Overall Length 13.5 cm (5 1/4")



EI-250-14
Straight



EI-251-14
Curved

Micro Needle Holders
Mikro-Nadelhalter
Micro Porta-agujas
Micro porte-aiguilles
Micro Portaghi



EI-254-14
Silcock Micro Needle Holder
With Lock
Overall Length 14.5 cm (5 ¾")



EI-260-13
Straight



EI-261-13
Curved



EI-266-16
Curved



EI-2EI-16
Curved

Micro Needle Holders
Mikro-Nadelhalter
Micro Porta-agujas
Micro porte-aiguilles
Micro Portaghi



EI-271-16
Micro Needle Holder
Curved, Smooth Jaws, Bayonet Shaped
Overall Length 16 cm (6 1/4")



Micro Needle Holder
Smooth Jaws, Bayonet Shaped

EI-2EI-23
Straight

EI-275-23
Curved

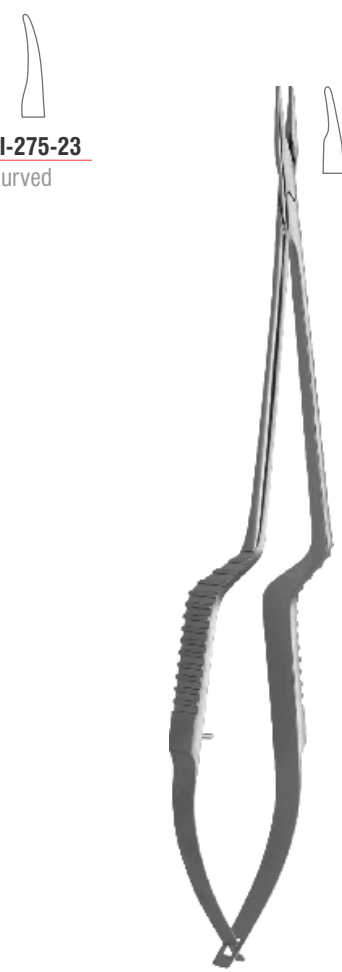

EI-277-19
Micro Needle Holder
Curved, Smooth Jaws, Bayonet Shaped,
Overall Length 19 cm (7 1/2")

Micro Needle Holders
Mikro-Nadelhalter
Micro Porta-agujas
Micro porte-aiguilles
Micro Portaghi



EI-280-20
Straight
20 cm (8")



EI-280-23
Straight
23 cm (8")



EI-281-20
Curved
20 cm (8")



EI-281-23
Curved
23 cm (8")

Yasargil Micro Needle Holder
Smooth Jaws, Bayonet Shaped



EI-300-10
Straight



EI-301-10
Curved

Barraquer-Troutman Micro Needle Holder
Extra Delicate, Round Handle
Overall Length 10 cm (4")



EI-310-10
Straight
10.5 cm (4")



EI-310-11
Straight
11.5 cm (4 1/2")



EI-311-10
Curved
10.5 cm (4")



EI-311-11
Curved
11.5 cm (4 1/2")

Barraquer-Troutman Micro Needle Holder
Very Delicate, Round Handle, With Lock



EI-313-11
Barraquer Micro Needle Holder
Curved, Delicate, Round Handle
Overall Length 11.5 cm (4 1/2")

Micro Needle Holders
Mikro-Nadelhalter
Micro Porta-agujas
Micro porte-aiguilles
Micro Portaghi



EI-315-11
Barraquer Micro Needle Holder
Curved, Delicate, Round Handle, With Lock
Overall Length 11.5 cm (4 1/2")



EI-315-11 T
Barraquer Micro Needle Holder
Curved, Delicate, Round Handle, With Lock
Overall Length 11.5 cm (4 1/2")



EI-320-13
Straight

EI-321-13
Curved

Barraquer Micro Needle Holder
Very Delicate, Round Handle, Without Lock
Overall Length 13 cm (5")



EI-322-13
Straight

EI-323-13
Curved

Barraquer Micro Needle Holder
Very Delicate, Round Handle, With Lock
Overall Length 13 cm (5")



Micro Needle Holders
Mikro-Nadelhalter
Micro Porta-agujas
Micro porte-aiguilles
Micro Portaghi



EI-331-14
Curved

EI-332-14
Straight

Barraquer Micro Needle Holder
Very Delicate, Round Handle
Overall Length 14 cm (5 1/2")



EI-331-14 T
Barraquer Micro Needle Holder
Curved, Very Delicate, Round Handle
Overall Length 14 cm (5 1/2")



EI-333-14
Barraquer Micro Needle Holder
Curved, Very Delicate, Round Handle, With Lock
Overall Length 14 cm (5 1/2")



EI-333-14 T
Barraquer Micro Needle Holder
Curved, Very Delicate, Round Handle, With Lock
Overall Length 14 cm (5 1/2")





Micro Needle Holders
Mikro-Nadelhalter
Micro Porta-agujas
Micro porte-aiguilles
Micro Portaghi



EI-341-12
Without Lock
EI-343-12
With Lock



Troutman Micro Needle Holder
Strongly Curved, Delicate, Round Handle
Overall Length 12 cm (4 3/4")



EI-350-15
Straight

EI-351-15
Curved

Reill Micro Needle Holder
Without Lock
Overall Length 15 cm (6")



EI-352-15
Straight

EI-353-15
Curved

Reill Micro Needle Holder
With Lock
Overall Length 15 cm (6")

Micro Needle Holders
Mikro-Nadelhalter
Micro Porta-agujas
Micro porte-aiguilles
Micro Portaghi



EI-354-18
Straight

Micro Needle Holder
Without Lock
Overall Length 18.5 cm (7 1/4")



EI-355-18
Curved

Micro Needle Holder
With Lock
Overall Length 18.5 cm (7 1/4")



EI-356-18
Straight



EI-357-18
Curved

EI-360-20
Straight
With Lock
20 cm (8")

EI-362-23
Straight, Delicate
With Lock
23 cm (9")

Micro Needle Holder

Micro Needle Holders
Mikro-Nadelhalter
Micro Porta-agujas
Micro porte-aiguilles
Micro Portaghi



EI-416-17

EI-418-17

Diam-n-Dust™ Micro Needle Holder
Straight, Without Lock
Overall Length 17 cm (6 3/4")



EI-420-14
14 cm (5 1/2")

EI-420-18
18 cm (7")

EI-420-21
21 cm (8 1/4")

EI-420-23
23 cm (9")

Diam-n-Dust™ Micro Needle Holder
Straight, Without Lock



EI-422-14
14 cm (5 1/2")

EI-422-18
18 cm (7")

EI-422-21
21 cm (8 1/4")

EI-422-23
23 cm (9")

Diam-n-Dust™ Micro Needle Holder
Straight, With Lock



Micro Needle Holders
 Mikro-Nadelhalter
 Micro Porta-agujas
 Micro porte-aiguilles
 Micro Portaghi

Without Lock



Overall Length	Suture Size 7/0 Straight	Suture Size 5/0 Straight	Suture Size 5/0 Curved	Suture Size 4/0 Straight	Suture Size 4/0 Curved
12 cm - 4 3/4"	EI-4EI-12	EI-430-12			
14 cm - 5 1/2"		EI-430-14	EI-431-14		
		EI-430-14 T	EI-431-14 T		
16 cm - 6 1/4"	EI-4EI-16	EI-430-16			
		EI-430-16 T			
18 cm - 7"	EI-4EI-18	EI-430-18	EI-431-18		
	EI-4EI-18 T	EI-430-18 T	EI-431-18 T		
21 cm - 8 1/4"	EI-4EI-21	EI-430-21	EI-431-21		
	EI-4EI-21 T	EI-430-21 T	EI-431-21 T		
23 cm - 9"	EI-4EI-23	EI-430-23	EI-431-23		
	EI-4EI-23 T	EI-430-23 T	EI-431-23 T		
25 cm - 9 3/4"	EI-4EI-25	EI-430-25			

With Lock



Overall Length	Suture Size 7/0 Straight	Suture Size 5/0 Straight	Suture Size 5/0 Curved	Suture Size 4/0 Straight	Suture Size 4/0 Curved
12 cm - 4 3/4"	EI-428-12	EI-432-12			
14 cm - 5 1/2"		EI-432-14	EI-433-14		
		EI-432-14 T	EI-433-14 T		
16 cm - 6 1/4"	EI-428-16	EI-432-16			
		EI-432-16 T			
18 cm - 7"	EI-428-18	EI-432-18	EI-433-18	EI-434-18	EI-435-18
	EI-428-18 T	EI-432-18 T	EI-433-18 T		
21 cm - 8 1/4"	EI-428-21	EI-432-21	EI-433-21	EI-434-21	EI-435-21
	EI-428-21 T	EI-432-21 T	EI-433-21 T		
23 cm - 9"	EI-428-23	EI-432-23	EI-433-23	EI-434-23	EI-435-23
	EI-428-23 T	EI-432-23 T	EI-433-23 T		
25 cm - 9 3/4"	EI-428-25	EI-432-25			



Diam-n-Dust™
 Micro Needle Holder
 Round Handle



Diam-n-Dust™
 Micro Needle Holder
 Round Handle



Micro Needle Holders
Mikro-Nadelhalter
Micro Porta-agujas
Micro porte-aiguilles
Micro Portaghi



EI-440-19
19 cm (7 1/2")
EI-440-23
23 cm (9")
EI-440-25
25 cm (9 3/4")



Diam-n-Dust™ Micro Needle Holder
Straight, Without Lock, Heavy Pattern, Round Handle



EI-442-19
19 cm (7 1/2")
EI-442-23
23 cm (9")
EI-442-25
25 cm (9 3/4")



Diam-n-Dust™ Micro Needle Holder
Straight, With Lock, Heavy Pattern, Round Handle



Micro Needle Holders
Mikro-Nadelhalter
Micro Porta-agujas
Micro porte-aiguilles
Micro Portaghi



EI-450-12
Diam-n-Dust™ Castroviejo Micro Needle Holder
Straight, With Lock
Overall Length 12.5 cm (5")



EI-452-18
Diam-n-Dust™ Hepp-Scheidel Micro Needle Holder
Straight, With Lock
Overall Length 18.5 cm (7 1/4")



Needle Holders
Nadelhalter
Porta-agujas
Porte-aiguilles
Portaghi

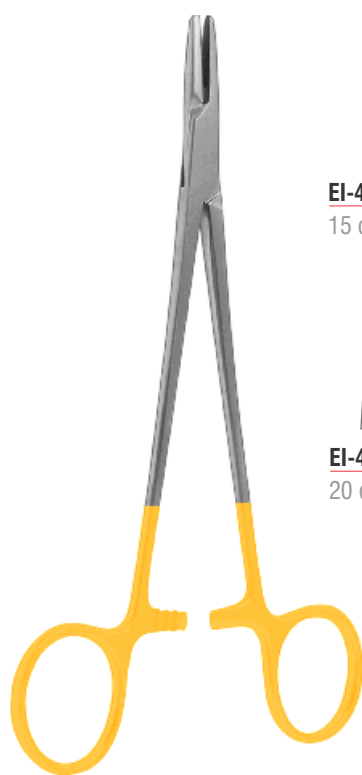

EI-460-15
15 cm (6")



EI-460-18
18 cm (7")



EI-460-20
20 cm (8")



EI-460-23
23 cm (9")



Diam-n-Dust™ DeBakey Needle Holder

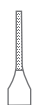

EI-470-13
13 cm (5")



EI-470-15
15 cm (6")

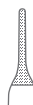

EI-470-18
18 cm (7")

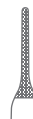

EI-470-22
22 cm (8 ¾")

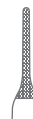

EI-470-25
25 cm (9 ¾")



Diam-n-Dust™ Ryder Vascular Needle Holder



Micro Needle Holders
Mikro-Nadelhalter
Micro Porta-agujas
Micro porte-aiguilles
Micro Portaghi



EI-500-13
UltraGrip™ TC Barraquer Micro Needle Holder
Curved, Smooth Jaws, Without Lock, Round Handle
Overall Length 13 cm (5")

ULTRA GRIP



EI-502-13
UltraGrip™ TC Barraquer Micro Needle Holder
Curved, Smooth Jaws, With Lock, Round Handle
Overall Length 13 cm (5")

ULTRA GRIP

Micro Needle Holders
Mikro-Nadelhalter
Micro Porta-agujas
Micro porte-aiguilles
Micro Portaghi



UltraGrip™ TC Castroviejo Micro Needle Holder
With Lock
Overall Length 14.5 (5 3/4")

ULTRA GRIP X™



UltraGrip™ TC Micro Needle Holder
With Lock
Overall Length 18 (7")

ULTRA GRIP X™

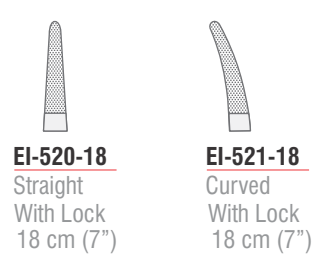

Micro Needle Holders
Mikro-Nadelhalter
Micro Porta-agujas
Micro porte-aiguilles
Micro Portaghi



EI-530-21
Straight
With Lock



EI-531-21
Curved
With Lock



EI-5EI-18



EI-5EI-20

UltraGrip™ TC Jacobson Micro Needle Holder
With Lock
Overall Length 21.5 cm (8 1/2")

UltraGrip™ TC Micro Needle Holder
Straight, With Lock
Overall Length 18 cm (7")

ULTRA GRIP

ULTRA GRIP



Micro Needle Holders
Mikro-Nadelhalter
Micro Porta-agujas
Micro porte-aiguilles
Micro Portaghi



EI-540-13
UltraGrip™ TC Castroviejo Micro Needle Holder
Smooth Jaws, With Lock
Overall Length 12.5 cm (5")

ULTRA GRIP X™



EI-544-18
UltraGrip™ TC Hepp-Scheidel Micro Needle Holder
Smooth Jaws, With Lock
Overall Length 18.5 cm (7 ¼")

ULTRA GRIP X™





Micro Needle Holders
Mikro-Nadelhalter
Micro Porta-agujas
Micro porte-aiguilles
Micro Portaghi



UltraGrip™ TC Diethrich Micro Needle Holder

ULTRA GRIP[™]

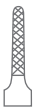
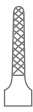

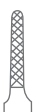
- | | |
|--|---|
|  |  |
| EI-550-16
16 cm (6 ¼") | EI-550-18
18 cm (7") |
|  |  |
| EI-550-20
20 cm (8") | EI-550-23
23 cm (9") |
|  | |
| EI-550-26
26 cm (10 ½") | |



UltraGrip™ TC Arruga Needle Holder
Overall Length 16 cm (6 ¼")

ULTRA GRIP[™]



Needle Holders
Nadelhalter
Porta-agujas
Porte-aiguilles
Portaghi



ULTRA GRIP[™]

EI-564-13
UltraGrip™ TC Webster Needle Holder
With Automatic Release Ratchet
Overall Length 13 cm (5")



ULTRA GRIP[™]

EI-566-15
UltraGrip™ TC Crile-Wood Needle Holder
With Automatic Release Ratchet
Overall Length 15 cm (6")



ULTRA GRIP[™]

EI-570-13
UltraGrip™ TC Webster Needle Holder
Smooth Jaws
Overall Length 13 cm (5")

Needle Holders
Nadelhalter
Porta-agujas
Porte-aiguilles
Portaghi



EI-573-13
UltraGrip™ TC Kilner Needle Holder
S Shaped
Overall Length 13 cm (5")

ULTRA GRIP X™



EI-576-12
UltraGrip™ TC Derf Needle Holder
Overall Length 12 cm (4 ¾")

ULTRA GRIP X™



Needle Holders
Nadelhalter
Porta-agujas
Porte-aiguilles
Portaghi



EI-580-13
13 cm (5")

EI-580-14
14.5 cm (5")

UltraGrip™ TC Hegar-Baumgartner Needle Holder

ULTRA GRIP[®]



EI-584-13
13 cm (5")
Smooth Jaws

EI-586-13
13 cm (5")

UltraGrip™ TC Halsey Needle Holder

ULTRA GRIP[®]



Needle Holders
Nadelhalter
Porta-agujas
Porte-aiguilles
Portaghi



EI-588-12
UltraGrip™ TC Webster Needle Holder
Smooth Jaw
Overall Length 12 cm (4 ¾")

ULTRA GRIP X™

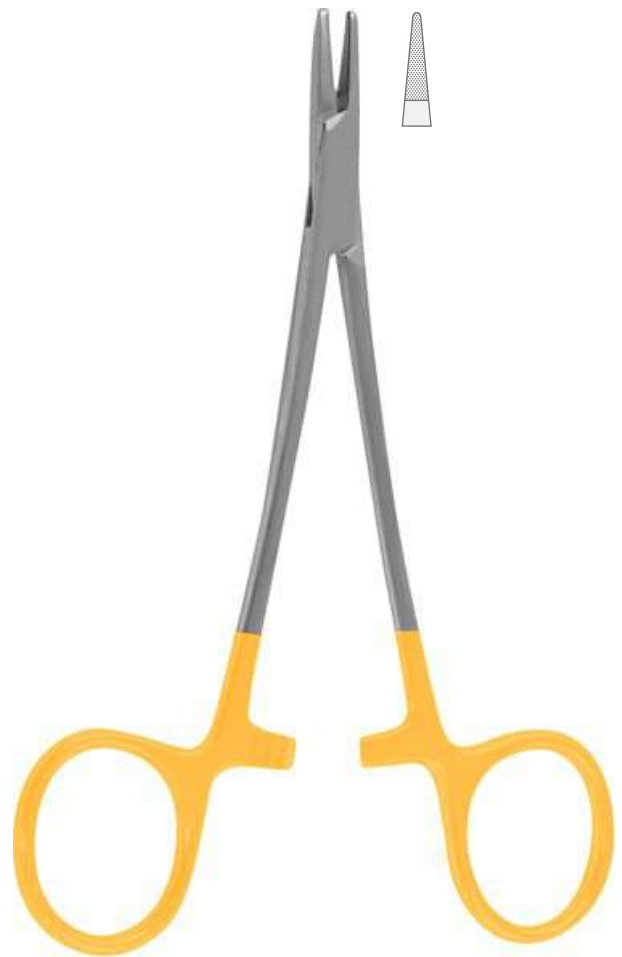

EI-590-12
UltraGrip™ TC Converse Needle Holder
Overall Length 12.5 cm (5")

ULTRA GRIP X™



Needle Holders
Nadelhalter
Porta-agujas
Porte-aiguilles
Portaghi



EI-594-15
15 cm (6")

EI-594-18
18 cm (7")

EI-594-20
20 cm (8")

UltraGrip™ TC Crile-Wood Needle Holder

ULTRA GRIP X



EI-598-18
18 cm (7")

EI-598-20
20 cm (8")

EI-598-26
26 cm (10 1/4")

UltraGrip™ TC Sarot Needle Holder

ULTRA GRIP X



Needle Holders
Nadelhalter
Porta-agujas
Porte-aiguilles
Portaghi



UltraGrip™ TC Mayo-Hegar Needle Holder



EI-600-14
14.5 cm (5 ¾")



EI-600-16
16 cm (6 ¼")



EI-600-18
18 cm (7")



EI-600-20
20 cm (8")



EI-600-24
24 cm (9 ½")



EI-600-26
26 cm (10 ¼")



EI-600-30
30 cm (11 ¾")

ULTRA GRIP X™



UltraGrip™ TC Hegar Needle Holder



EI-602-20
20 cm (8")



EI-602-24
23.5 cm (9 ¼")

ULTRA GRIP X™



Needle Holders
Nadelhalter
Porta-agujas
Porte-aiguilles
Portaghi



UltraGrip™ TC Heaney Needle Holder

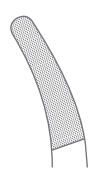

EI-605-20
20 cm (8")

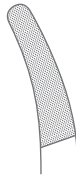

EI-605-24
24 cm (9 1/2")

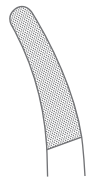

EI-605-26
26 cm (10 1/4")



UltraGrip™ TC Bozemann Needle Holder



EI-611-20
20.5 cm (8")

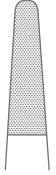

EI-611-24
24 cm (9 1/2")



EI-611-26
26.5 cm (10 1/2")



EI-611-28
29 cm (11 1/2")

ULTRA GRIP X™



ULTRA GRIP X™



Needle Holders
Nadelhalter
Porta-agujas
Porte-aiguilles
Portaghi

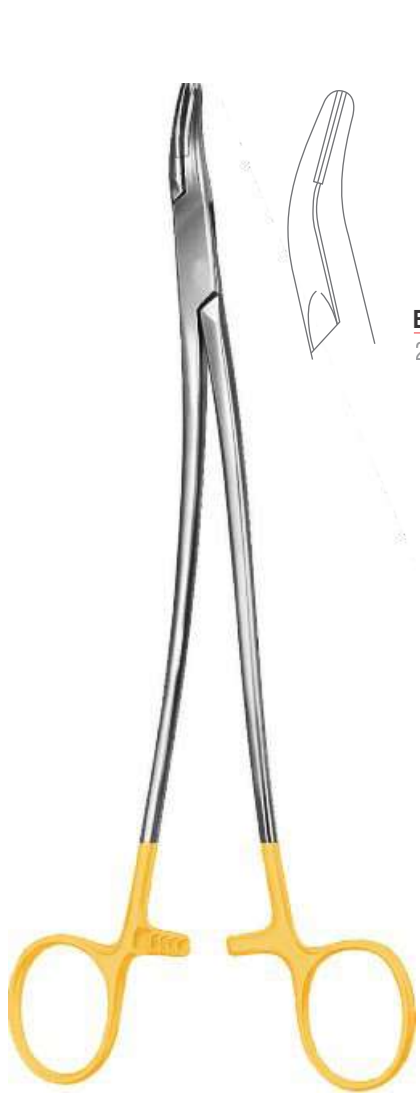

EI-615-21
21 cm (8 ¼")

EI-615-23
23 cm (9")

UltraGrip™ TC Stratte Needle Holder

ULTRA GRIP X™



EI-620-27
UltraGrip™ TC Masson Needle Holder
Overall Length 26.5 cm (10 ½")

ULTRA GRIP X™



Needle Holders
Nadelhalter
Porta-agujas
Porte-aiguilles
Portaghi

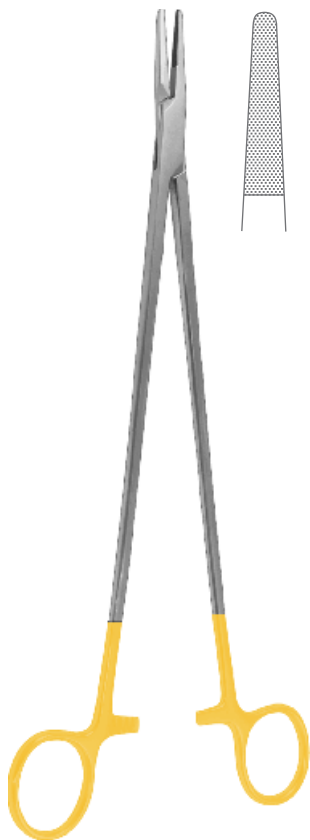

EI-624-27
UltraGrip™ TC Wangensteen Needle Holder
Overall Length 27 cm (10 3/4")

ULTRA GRIP X



EI-625-27
UltraGrip™ TC Needle Holder
Overall Length 27 cm (10 3/4")

ULTRA GRIP X



EI-627-27
UltraGrip™ TC Finochietto Needle Holder
Overall Length 26.5 cm (10 1/2")

ULTRA GRIP X



Needle Holders
Nadelhalter
Porta-agujas
Porte-aiguilles
Portaghi







EI-630-26
UltraGrip™ TC Naunton-Morgan Needle Holder
Compound Action
Overall Length 26 cm (10 1/4")

ULTRA GRIP X



UltraGrip™ TC DeBakey Needle Holder

- | | | |
|---|---|--|
|  |  |  |
| EI-650-18
18 cm (7") | EI-650-20
20 cm (8") | EI-650-23
23 cm (9") |
|  |  | |
| EI-650-26
26 cm (10 1/4") | EI-650-31
31 cm (12 1/4") | |

ULTRA GRIP X



Needle Holders
Nadelhalter
Porta-agujas
Porte-aiguilles
Portaghi

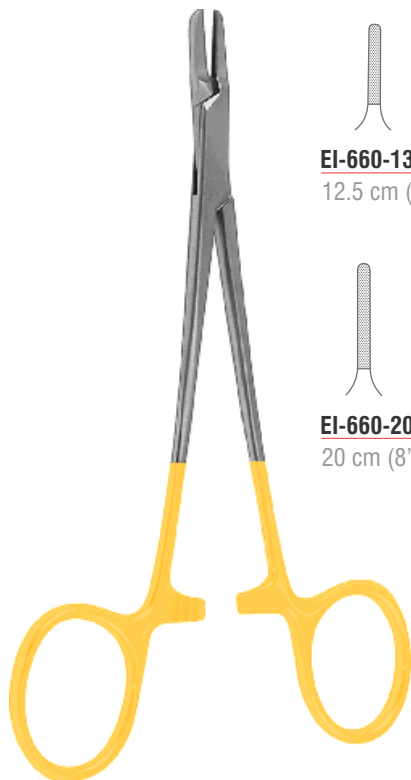

UltraGrip™ TC Ryder Needle Holder

EI-660-13 12.5 cm (5")	EI-660-15 15 cm (6")	EI-660-18 18 cm (7")
EI-660-20 20 cm (8")	EI-660-23 23 cm (9")	EI-660-26 26 cm (10 1/4")

ULTRA GRIP X



UltraGrip™ TC Ryder-Vascular Needle Holder

EI-664-13 12.5 cm (5")	EI-664-15 15 cm (6")	EI-664-18 18 cm (7")
EI-664-20 20 cm (8")	EI-664-23 22.5 cm (8 3/4")	EI-664-26 26 cm (10 1/4")

ULTRA GRIP X



Needle Holders
Nadelhalter
Porta-agujas
Porte-aiguilles
Portaghi



EI-670-15
15 cm (6")

EI-670-17
17 cm (6 ¾")

EI-670-20
20 cm (8")

UltraGrip™ TC Martin Needle Holder

ULTRA GRIP X



Needle Holders
Nadelhalter
Porta-agujas
Porte-aiguilles
Portaghi

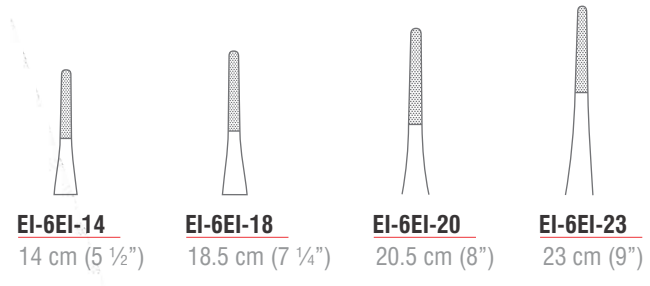

ULTRA GRIP[®]



UltraGrip™ TC Hegar-Vascular Needle Holder

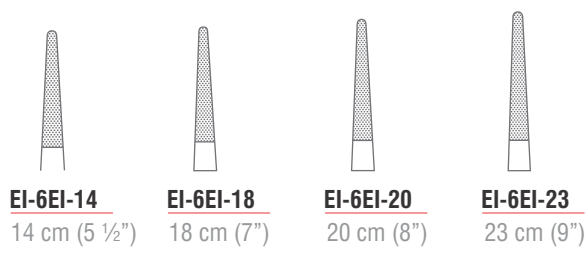

ULTRA GRIP[®]



UltraGrip™ TC Micro Vascular Needle Holder

Needle Holders
Nadelhalter
Porta-agujas
Porte-aiguilles
Portaghi



UltraGrip™ TC Martini Needle Holder



EI-680-14
Smooth Jaws
14 cm (5 ½")



EI-680-16
Smooth Jaws
16 cm (6 ¼")



EI-680-18
Smooth Jaws
18 cm (7")



EI-680-20
Smooth Jaws
20 cm (8")



EI-682-14
14 cm (5 ½")



EI-682-16
16 cm (6 ¼")



EI-682-18
18 cm (7")



EI-682-20
20 cm (8")

ULTRA GRIP X



Needle Holders
Nadelhalter
Porta-agujas
Porte-aiguilles
Portaghi



EI-690-14
14.5 cm (5 ¾")



EI-690-17
17 cm (6 ¾")



EI-690-18
19 cm (7 ½")



ULTRA GRIP X



UltraGrip™ TC Olsen-Hegar Needle Holder



EI-693-11
UltraGrip™ TC Foster-Gillies Needle Holder
Smooth Jaws
Overall Length 11 cm (4 ¼")

ULTRA GRIP X



EI-695-15
UltraGrip™ TC Gillies-Mini Needle Holder
Overall Length 15 cm (6")

ULTRA GRIP X



EI-697-16
UltraGrip™ TC Gillies Needle Holder
Overall Length 16 cm (6 ¼")

ULTRA GRIP X



Needle Holders
Nadelhalter
Porta-agujas
Porte-aiguilles
Portaghi



EI-700-14
14 cm (5 1/2")

EI-700-17
17 cm (6 3/4")

EI-700-20
20 cm (8")

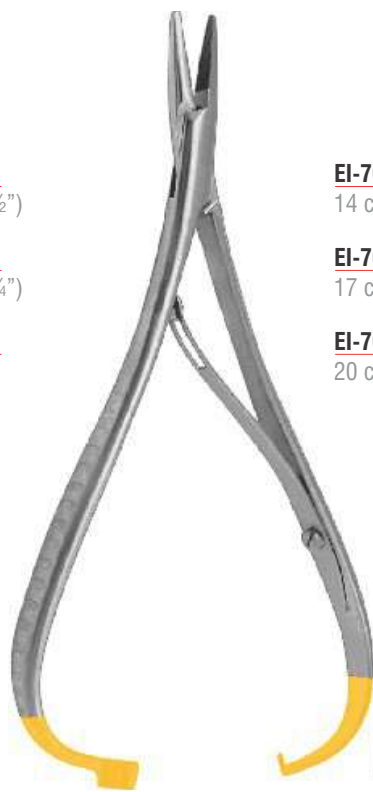

EI-702-14
14 cm (5 1/2")

EI-702-17
17 cm (6 3/4")

EI-702-20
20 cm (8")



EI-706-17
17 cm (6 3/4")

EI-706-20
20 cm (8")

EI-706-23
23 cm (9")

UltraGrip™ TC Mathieu Needle Holder

UltraGrip™ TC Mathieu Needle Holder

UltraGrip™ TC Mathieu Needle Holder

ULTRA GRIP X

ULTRA GRIP X

ULTRA GRIP X



Needle Holders
Nadelhalter
Porta-agujas
Porte-aiguilles
Portaghi



EI-710-20
UltraGrip™ TC Lichtenberg Needle Holder
Overall Length 20 cm (8")



EI-720-20
20.5 cm (8")
EI-720-23
23 cm (9")

UltraGrip™ TC Zweifel Needle Holder
With Hinged Ratchet



EI-730-18
UltraGrip™ TC Toennis Needle Holder
Overall Length 18.5 cm (7 1/4")



EI-740-18
18 cm (7")
EI-740-18
20.5 cm (8")
EI-740-18
23 cm (9")

UltraGrip™ TC Langenbeck Needle Holder

Ligature Clip Applier
 Ligatur Clip Anlegezangen
 Aplicador de clips para ligadura
 Appicateur de pince à ligature
 Applicatore di clip per legature



Ligature Clip Applier



EI-751-25
 Angled 25°
 15 cm (6")



EI-753-25
 Angled 25°
 20 cm (8")



EI-753-65
 Angled 65°
 20 cm (8")



EI-755-25
 Angled 25°
 28 cm (11")



EI-755-65
 Angled 65°
 28 cm (11")

For Small Clips



EI-761-25
 Angled 25°
 15 cm (6")



EI-763-25
 Angled 25°
 20 cm (8")



EI-763-65
 Angled 65°
 20 cm (8")



EI-765-25
 Angled 25°
 28 cm (11")



EI-765-65
 Angled 65°
 28 cm (11")

For Medium Clips

Ligature Clip Applier
 Ligatur Clip Anlegezangen
 Aplicador de clips para ligadura
 Appicateur de pince à ligature
 Applicatore di clip per legature



Ligature Clip Applier



EI-773-25
 Angled 25°
 20 cm (8")



EI-773-65
 Angled 65°
 20 cm (8")



EI-773-90
 Angled 90°
 20 cm (8")



EI-775-25
 Angled 25°
 28 cm (11")



EI-775-65
 Angled 65°
 28 cm (11")



EI-775-90
 Angled 90°
 28 cm (11")

For Medium/Large Clips

Ligature Clip Applier
Ligatur Clip Anlegezangen
Aplicador de clips para ligadura
Applicateur de pince à ligature
Applicatore di clip per legature



Ligature Clip Applier



EI-783-25
Angled 25°
20 cm (8")



EI-783-65
Angled 65°
20 cm (8")



EI-783-90
Angled 90°
20 cm (8")



EI-785-25
Angled 25°
28 cm (11")



EI-785-65
Angled 65°
28 cm (11")



EI-785-90
Angled 90°
28 cm (11")

For Large Clips

Ligature Needles
 Unterbindungsnadeln
 Aguja para ligaduras
 Aiguilles à ligatures
 Aghi per legatura



EI-801-15

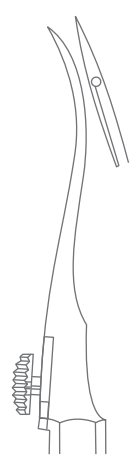

EI-803-15



EI-805-15

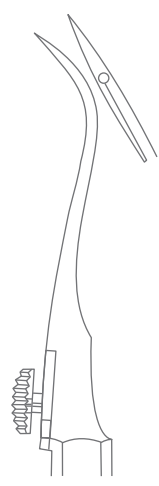

EI-807-15

Reverdin Ligature Needle
 Short
 Overall Length 14.5 cm (5 3/4")

Ligature Needles
Unterbindungsnadeln
Agujas para ligaduras
Aiguilles à ligatures
Aghi per legatura

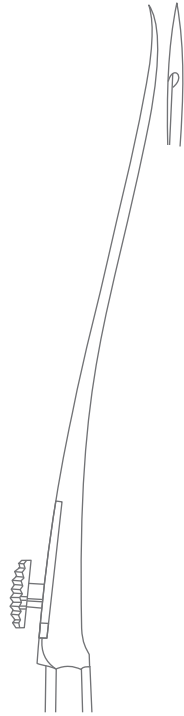

EI-811-19

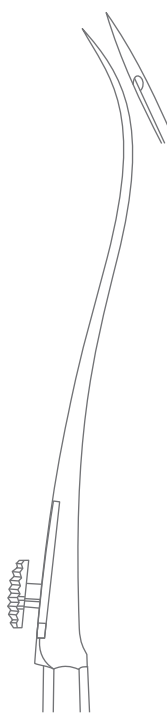

EI-813-19

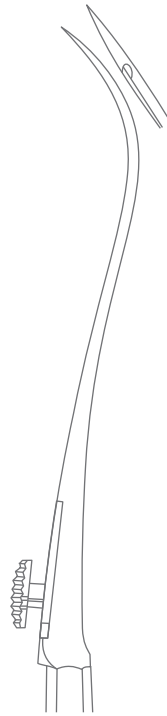

EI-815-19

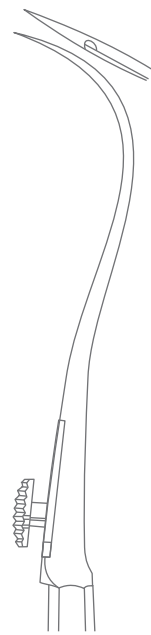

EI-817-19

Reverdin Ligature Needle
Medium
Overall Length 19.5 cm (7 3/4")

Ligature Needles
 Unterbindungsnadeln
 Aguja para ligaduras
 Aiguilles à ligatures
 Aghi per legatura

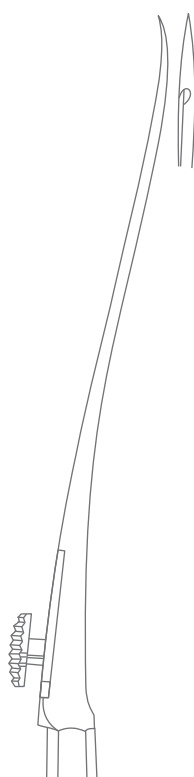

EI-821-23

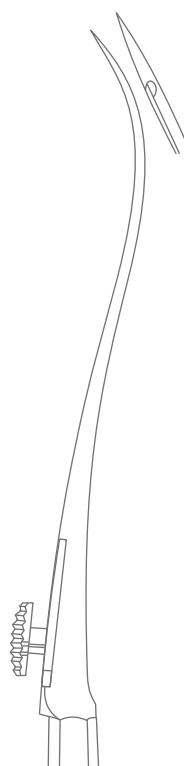

EI-823-23

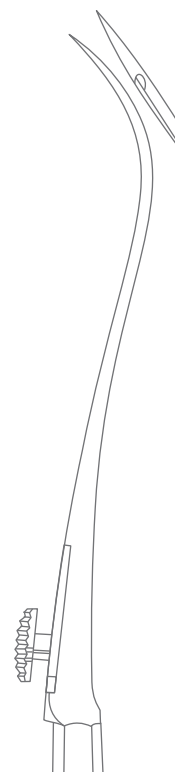

EI-825-23



EI-827-23

Reverdin Ligature Needle
 Large
 Overall Length 23 cm (9")

Ligature Needles
 Unterbindungsnadeln
 Agujas para ligaduras
 Aiguilles à ligatures
 Aghi per legatura

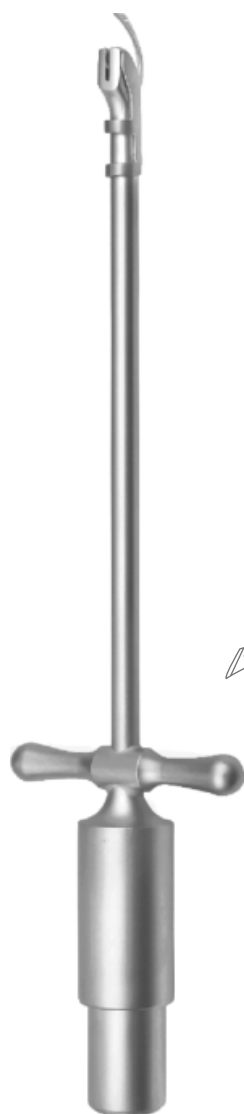

EI-831-00
Young Ligature Needle Holder Complete
 With Needle Ref: EI-831-01
 Overall Length 24.5 cm (9 3/4")



EI-831-01
 Fig. 1

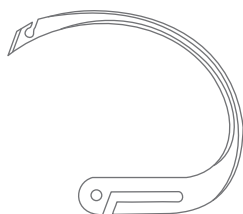

EI-831-02
 Fig. 2

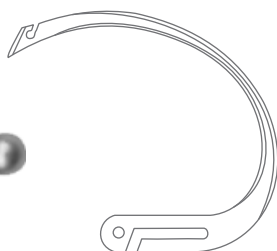

EI-831-03
 Fig. 3

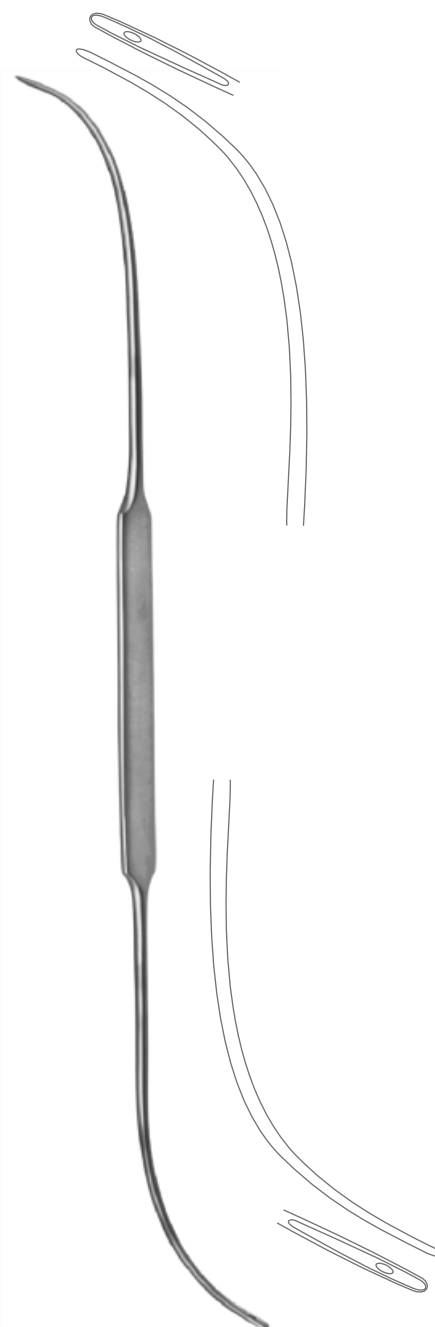

EI-835-32
Schmieden-Dick Ligature Needle
 Malleable
 Overall Length 29 cm (11 1/2")



EI-8EI-21
Schmieden Ligature Needle
 Overall Length 24 cm (9 1/2")

Ligature Needles
 Unterbindungsnadeln
 Aguja para ligaduras
 Aiguilles à ligatures
 Aghi per legatura



EI-841-20
Ligature Needle
 Malleable
 Overall Length 20.5 cm (8")



EI-843-18
Jonesco Ligature Needle
 Overall Length 18.5 cm (7 1/4")



EI-845-25
Claus Van Eicken Ligature Needle
 Overall Length 25 cm (9 3/4")

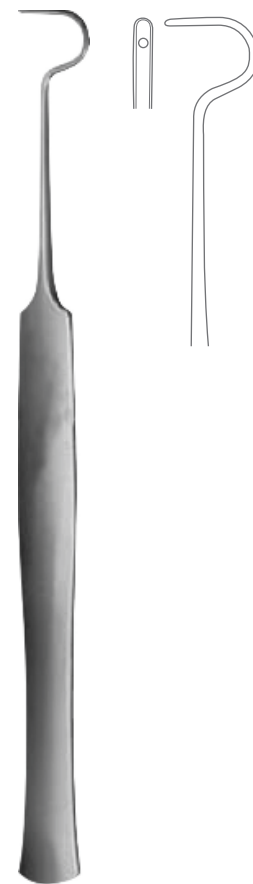

EI-8EI-15
Ligature Needle
 Overall Length 15 cm (6")

Ligature Needles
Unterbindungsnadeln
Agujas para ligaduras
Aiguilles à ligatures
Aghi per legatura

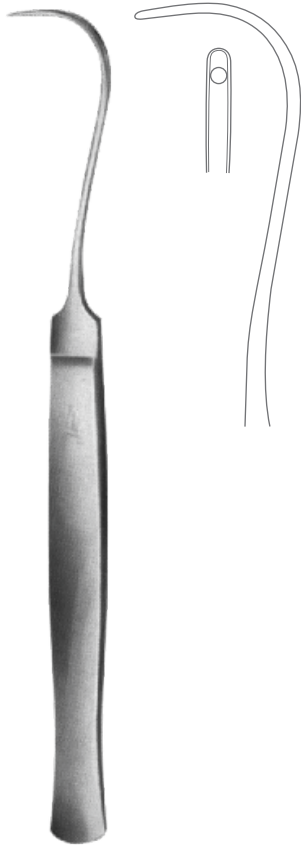

EI-851-17
Syme Ligature Needle
Overall Length 17 cm (6 ¾")



EI-853-19
Cooper Ligature Needle
Overall Length 18.5 cm (7 ¼")

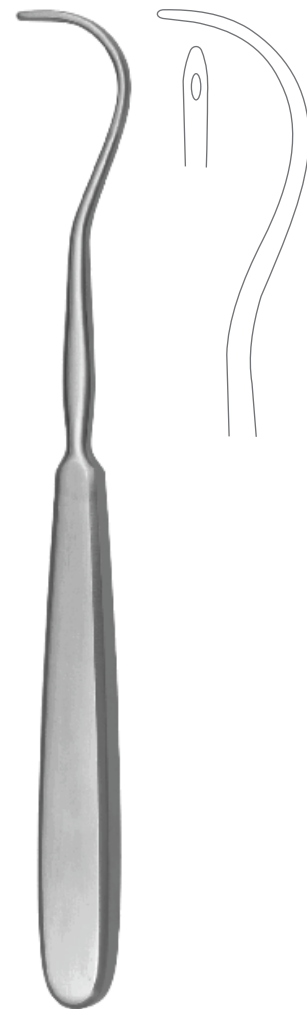

EI-855-20
Kocher Ligature Needle
Overall Length 20.5 cm (8")

Ligature Needles
 Unterbindungsnadeln
 Aguja para ligaduras
 Aiguilles à ligatures
 Aghi per legatura



Kronecker Ligature Needle
 Delicate
 Overall Length 12.5 cm (5")



EI-861-13
 Right Hand



EI-863-13
 Left Hand



Deschamps Ligature Needle
 Blunt
 Overall Length 24 cm (9 1/2")

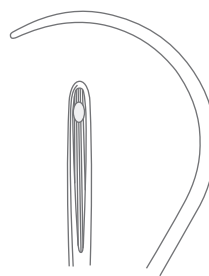

EI-871-24
 Right Hand

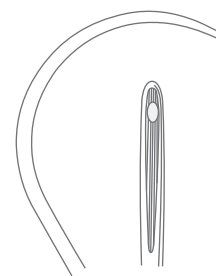

EI-873-24
 Left Hand

Ligature Needles
Unterbindungsnadeln
Agujas para ligaduras
Aiguilles à ligatures
Aghi per legatura



EI-875-20
Right Hand

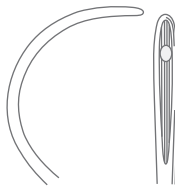

EI-877-20
Left Hand



EI-879-20
Left Hand

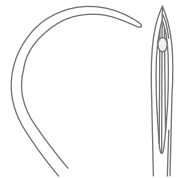

EI-881-20
Left Hand

Deschamps Ligature Needle
Blunt
Overall Length 20 cm (8")

Deschamps Ligature Needle
Sharp
Overall Length 20 cm (8")

Ligature Needles
Unterbindungsnadeln
Agujas para ligaduras
Aiguilles à ligatures
Aghi per legatura

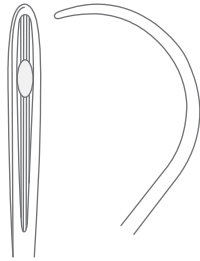

EI-883-21
Right Hand

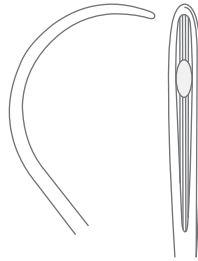

EI-885-21
Left Hand

Deschamps Ligature Needle
Blunt
Overall Length 20 cm (8")



EI-8EI-20
Right Hand



EI-889-20
Left Hand

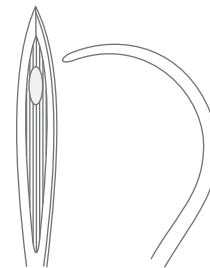

EI-891-21
Right Hand

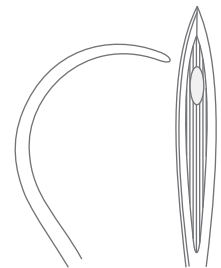

EI-893-21
Left Hand

Deschamps Ligature Needle
Sharp
Overall Length 20 cm (8")

Deschamps Ligature Needle
Sharp
Overall Length 20 cm (8")

Ligature Needles
Unterbindungsnadeln
Agujas para ligaduras
Aiguilles à ligatures
Aghi per legatura

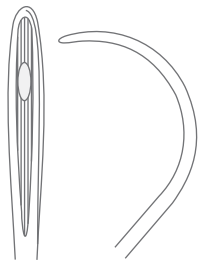

EI-895-27
Blunt, Right Hand

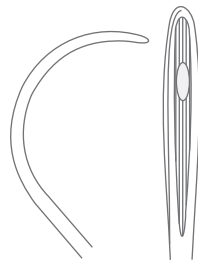

EI-897-27
Blunt, Left Hand

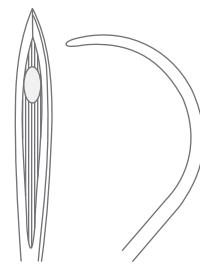

EI-901-27
Sharp, Right Hand

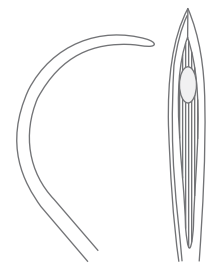

EI-903-27
Sharp, Left Hand

Deschamps Ligature Needle
Overall Length 27 cm (10 3/4")

Ligature Needles
 Unterbindungsnadeln
 Agujas para ligaduras
 Aiguilles à ligatures
 Aghi per legatura

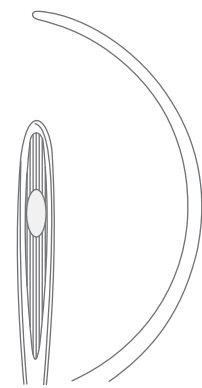

EI-905-28
Right Hand

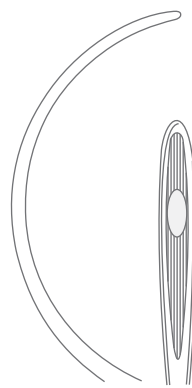

EI-907-28
Left Hand

Deschamps Ligature Needle
Blunt
Overall Length 28 cm (11")

Ligature Needles
Unterbindungsnadeln
Agujas para ligaduras
Aiguilles à ligatures
Aghi per legatura



Deschamps Ligature Needle
Sharp
Overall Length 20 cm (8")



EI-911-20
Right Hand



EI-913-20
Left Hand



Deschamps Ligature Needle
Blunt
Overall Length 20 cm (8")



EI-915-20
Right Hand

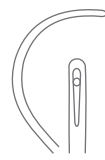

EI-917-20
Left Hand

Ligature Needles
 Unterbindungsnadeln
 Aguja para ligaduras
 Aiguilles à ligatures
 Aghi per legatura



Deschamps Ligature Needle
 Blunt
 Overall Length 21 cm (8 1/4")



EI-921-20
 Right Hand



EI-923-20
 Left Hand



Hurd Ligature Needle
 Sharp
 Overall Length 20.5 cm (8")



EI-927-21
 Right Hand

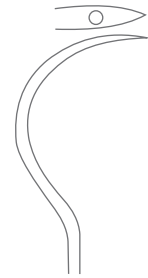

EI-929-21
 Left Hand

Ligature Needles
Unterbindungsnadeln
Agujas para ligaduras
Aiguilles à ligatures
Aghi per legatura

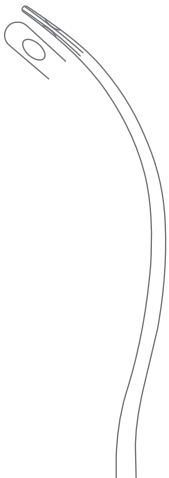

EI-931-01
Fig. 1

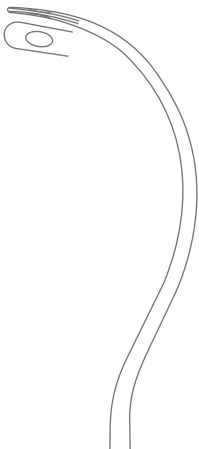

EI-931-02
Fig. 2

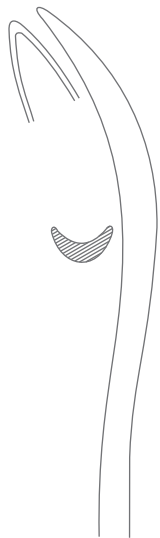

EI-931-03
Fig. 3

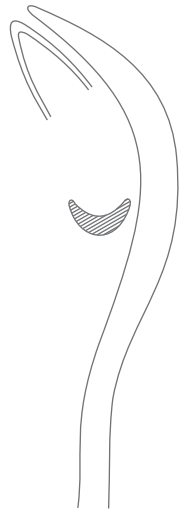

EI-931-04
Fig. 4

Brunner Ligature Needle
Overall Length 30 cm (11 3/4")

Ligature Needles
 Unterbindungsnadeln
 Aguja para ligaduras
 Aiguilles à ligatures
 Aghi per legatura

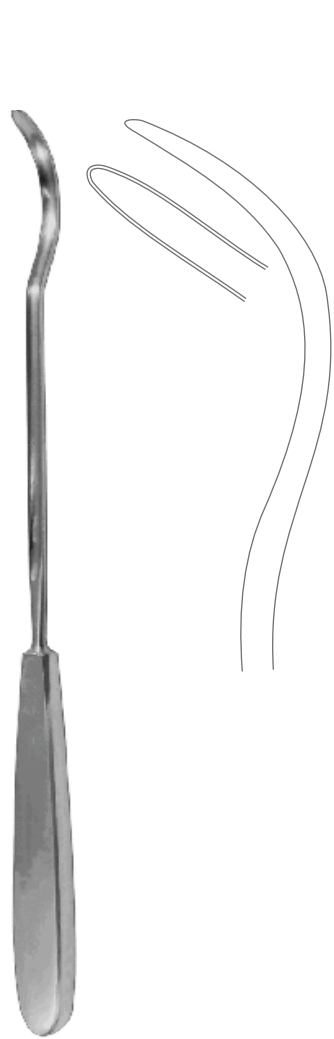

EI-935-25
Kirschner Ligature Needle
 Overall Length 25.5 cm (10")

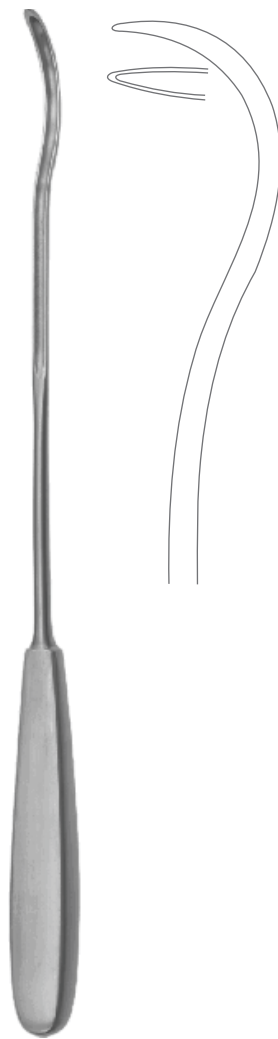

EI-9EI-28
Ligature Needle
 Overall Length 28 cm (11")

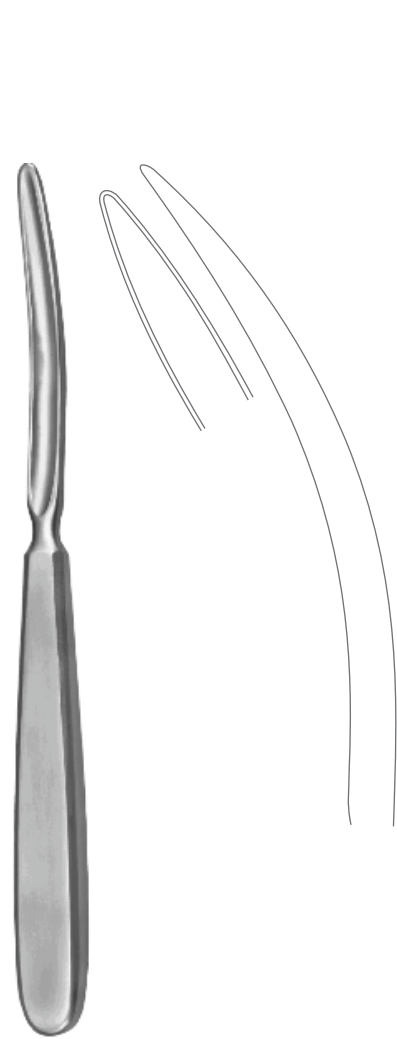

EI-939-25
Martin Ligature Needle
 Overall Length 19.5 cm (7 3/4")

Ligature Needles
Unterbindungsnadeln
Agujas para ligaduras
Aiguilles à ligatures
Aghi per legatura



EI-941-18
Brunner Ligature Conductor
Ferrozell
Overall Length 18 cm (7")



EI-943-27
Kirschner Ligature Conductor
Ferrozell
Overall Length 27 cm (10 3/4")



EI-945-19
Ligature Conductor
Ferrozell
Overall Length 19 cm (7 1/2")



EI-9EI-24
Ligature Conductor
Ferrozell
Overall Length 24 cm (9 1/2")

Ligature Needles
 Unterbindungsnadeln
 Aguja para ligaduras
 Aiguilles à ligatures
 Aghi per legatura



Schmieden Ligature Needle
 Overall Length 18 cm (8")

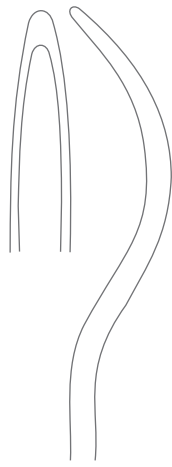

EI-951-19
 Without Eye



EI-953-19
 With Eye



Schmieden Ligature Needle
 Overall Length 19.5 cm (7 3/4")



EI-955-03



EI-955-05

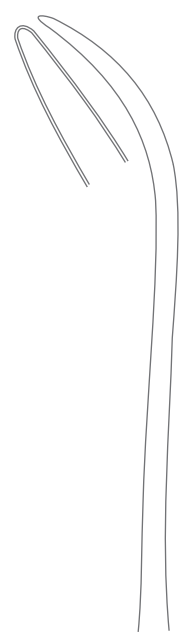

EI-955-07

Ligature Needles
Unterbindungsnadeln
Agujas para ligaduras
Aiguilles à ligatures
Aghi per legatura



Payr Ligature Needle
Overall Length 22 cm (8 3/4")

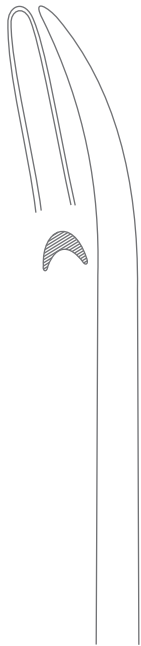

EI-957-22



EI-959-22



EI-961-23
Modell Wien Ligature Catcher
Overall Length 23.5 cm (9 1/4")



EI-963-21
Bozemann Knot Tier
Overall Length 21 cm (8 1/4")

Ligature Conductors
Führungshohlsonden
Sondas conductoras
Sondes conductrices
Sonde conduttrici



EI-965-23
Ligature Adjuster
Overall Length 23 cm (9")



EI-9EI-23
Caspar Ligature Adjuster
Bayonet Shaped
Overall Length 23 cm (9")



EI-969-24
Millin Ligature Holding Forcep
Overall Length 24 cm (9 1/2")

Clip Applying Forceps
Wundklammerpinzetten, Wundklammerzängchen
Pinzas aplicadoras para agrafes
Pincas à poser les agrafes
Pinze per applicare le agrafe



EI-980-18
Childe Approximation Forcep
Heavy Pattern With Clip Holder
Overall Length 17.5 cm (7")



EI-984-12
Michel Clip Applying Forcep
Overall Length 12 cm (4 3/4")



EI-986-12
Hegenbarth Clip Applying Forcep
Overall Length 12 cm (4 3/4")

Clip Applying Forceps
Wundklammerpinzetten, Wundklammerzängchen
Pinzas aplicadoras para agrafes
Pincas à poser les agrafes
Pinze per applicare le agrafe



EI-988-12
Wachenfeldt Clip Applying Forcep
Overall Length 12 cm (4 ¾")



EI-990-12
Michel Clip Applying & Removing Forcep
For Applying and Removal of Clips
Overall Length 12.5 cm (5")



EI-992-12
Michel Clip Applying & Removing Forcep
Long Jaws For Applying and Removal of Clips
Overall Length 13 cm (5")

Clip Applying Forceps
Wundklammerpinzetten, Wundklammerzängchen
Pinzas aplicadoras para agrafes
Pincas à poser les agrafes
Pinze per applicare le agrafe

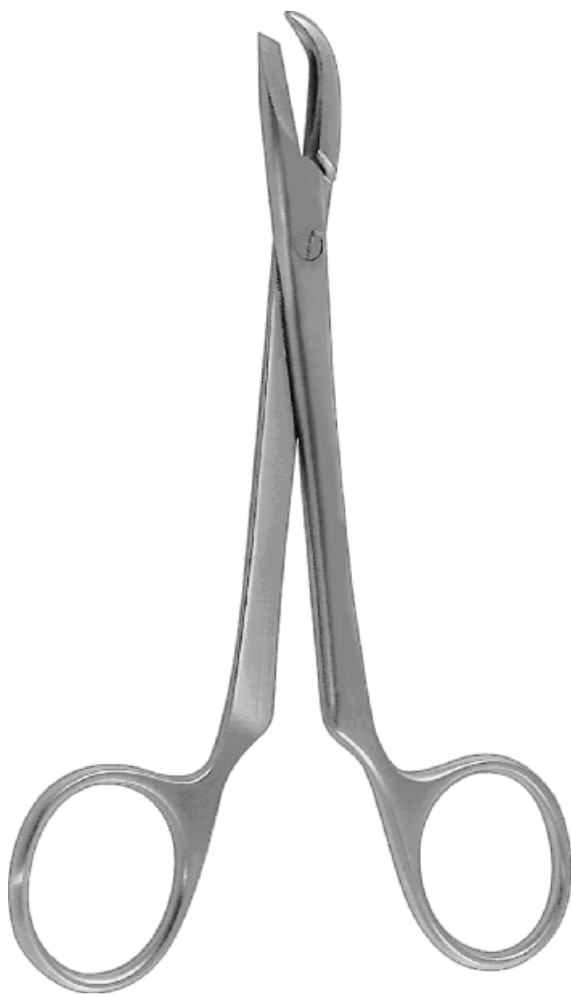

EI-994-13
Collin Clip Applying Forcep
With Screw Lock
Overall Length 13 cm (5")

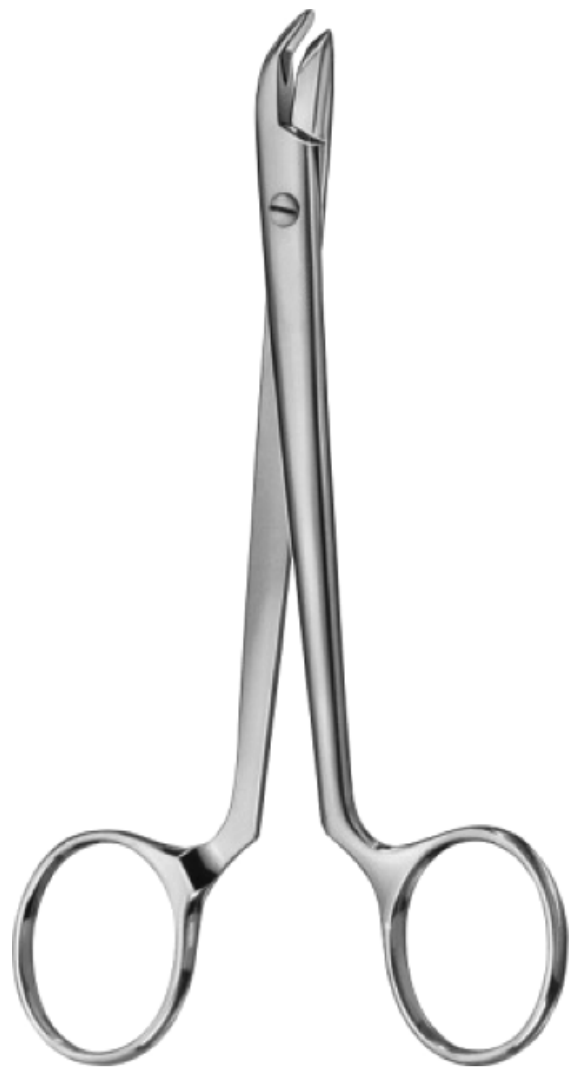

EI-995-14
Clip Applying Forcep
Overall Length 14 cm (5 1/2")

Clip Applying Forceps
Wundklammerpinzetten, Wundklammerzängchen
Pinzas aplicadoras para agrafes
Pinces à poser les agrafes
Pinze per applicare le agrafe



EI-997-14
Richter Clip Applying Forcep
With Screw Lock
Overall Length 13.5 cm (5 1/4")



Surgical Needle
Pack of 12



EI-999-01
7.5 x 1.75 mm



EI-999-02
11 x 2.0 mm



EI-999-03
12 x 3.0 mm



EI-999-04
14 x 3.0 mm



EI-999-05
16 x 3.0 mm



EI-999-06
18 x 3.0 mm



EI-999-07
20 x 3.0 mm



EI-999-08
22 x 3.0 mm



EI-999-09
22 x 3.0 mm

EI-998-04
Fig. 4

EI-998-08
Fig. 8

EI-998-20
Fig. 00, 1/2 Circle

Michel Suture Clips
Pack of 1000

Plaster Shears, Plaster Knives
Gipsscheren, Gipsmesser
Tijeras para yeso, Cuchillos para yeso
Ciseaux pour plâtre, Couteaux pour plâtre
Forbici per gesso, Coltelli per gesso

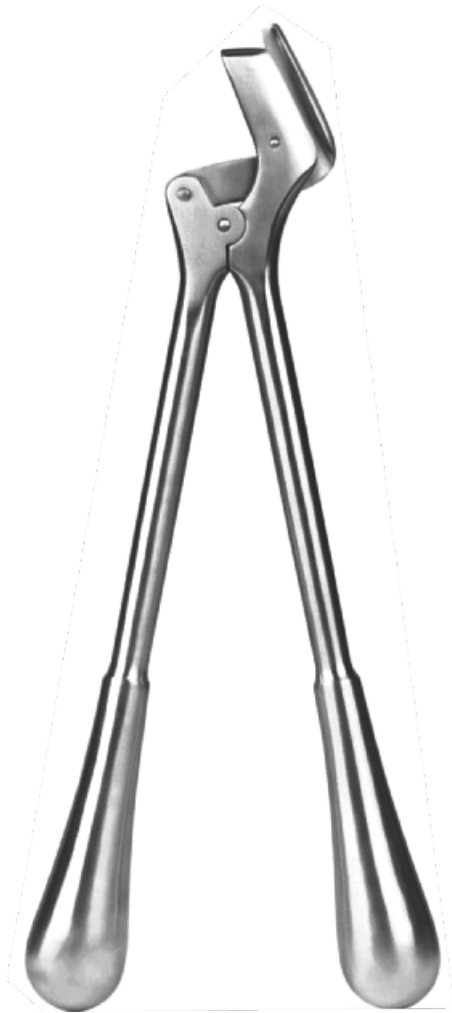

Stille Plaster of Paris Shear

EI-100-23
23 cm (9")

EI-100-26
27 cm (10 3/4")

EI-100-37
38 cm (15")



EI-150-20
Hopkins Plaster Knife
Overall Length 20 cm (8")



EI-156-18
Esmarch Plaster Knife
Overall Length 18 cm (8")

Plaster Knives, Plaster Spreaders
 Gipsmesser, Gipsspreizer
 Cuchillos para yeso, Separadores para yeso
 Couteaux pour plâtre, Pinces pour plâtre
 Coltelli per gesso, Pinze per gesso



EI-160-18
Reiner Plaster Knife
 Overall Length 18 cm (7")



EI-164-21
Martin Plaster Knife
 Overall Length 21 cm (8 1/4")



EI-171-15
Engel Plaster Knife
 Overall Length 15.5 cm (6")



EI-200-48
Beeson Plaster Knife
 Overall Length 30 cm (12")

Plaster Spreaders
Gipsspreizer
Separadores para yeso
Pinces pour plâtre
Pinze per gesso

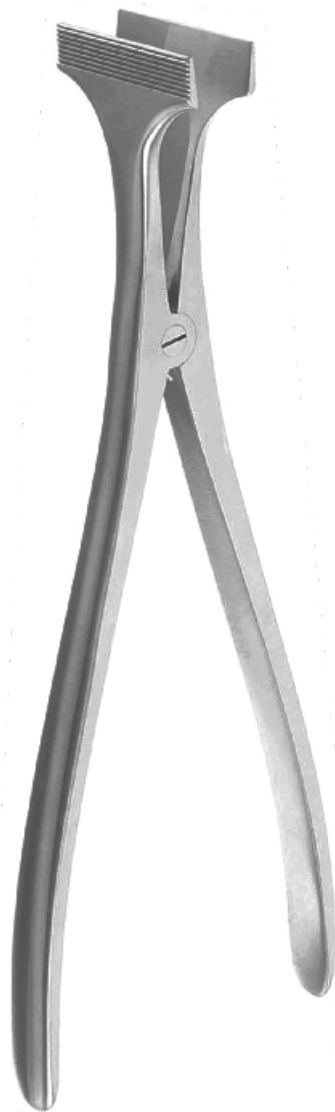

EI-220-28
Hennig Plaster Spreader
Overall Length 28 cm (11")



EI-228-23
Quattro (Mod. USA) Plaster Spreader
Overall Length 23 cm (9")



EI-251-18
18 cm (7")

EI-251-26
26.5 cm (10 ½")

Wolf Plaster Breaker

Plaster Shears
Gipsscheren
Tijeras para yeso
Ciseaux pour plâtre
Forbici per gesso



EI-300-00
220 V

EI-300-01
110 V

Surtex OsciPower™ Plaster Saw



EI-320-01
Wrench
Pair

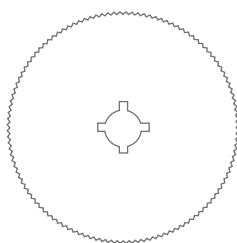

Round Saw Blade

EI-310-44
Ø 44 mm

EI-310-50
Ø 50 mm

EI-310-65
Ø 65 mm

EI-310-80
Ø 80 mm

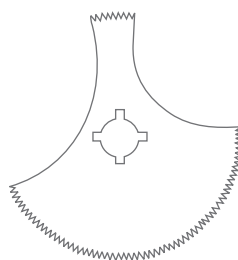

EI-314-65
Segment Saw Blade
Ø 65 mm

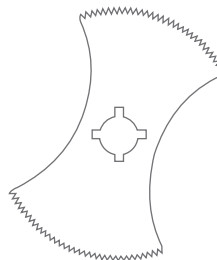

EI-318-65
Waisted Saw Blade
Ø 65 mm

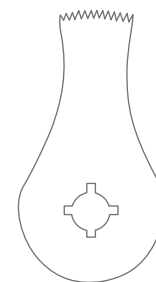

EI-320-70
Deep Saw Blade
Ø 70 mm

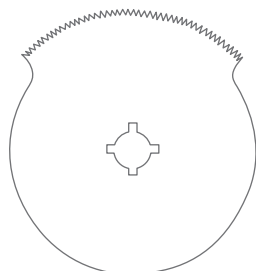

EI-322-80
Deep Saw Blade For Aspiration
Ø 80 mm



Vacuum Cleaner
Knopfsonden, Hohlsonden
Sondas abotonadas, Sondas acanaladas
Sondes boutonnées, Sondes cannelées
Sonde a bottone, Sonde cannellate



EI-400-00
Vacuum Cleaner

Amputation Saws
Amputationssägen
Sierras de amputación
Scies à amputation
Seghe per amputazione



EI-010-35
Charriere Amputation Saw Complete
With Saw Blade Ref: EI-010-92
Overall Length 35 cm (13 3/4")



- EI-010-91**
12 mm
- EI-010-92**
15 mm
- EI-010-93**
18 mm

Charriere Saw Blade



EI-012-40
Bier Amputation Saw Complete
With Saw Blade Ref: EI-012-92
Overall Length 40.5 cm (16")



- EI-012-91**
4 mm
- EI-012-92**
6 mm
- EI-012-93**
8 mm

Bier Saw Blade

Amputation Saws
Amputationssägen
Sierras de amputación
Scies à amputation
Seghe per amputazione

EVA

BONE SURGERY



EI-014-24
Langenbeck Amputation Saw
Overall Length 24.5 cm (9 3/4")

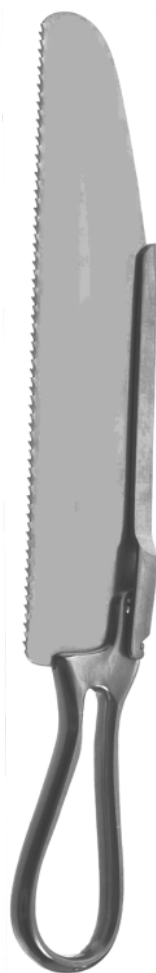

EI-016-27
Charriere Amputation Saw Complete
With Saw Blade Ref: EI-016-90
Overall Length 26.5 cm (10 1/2")

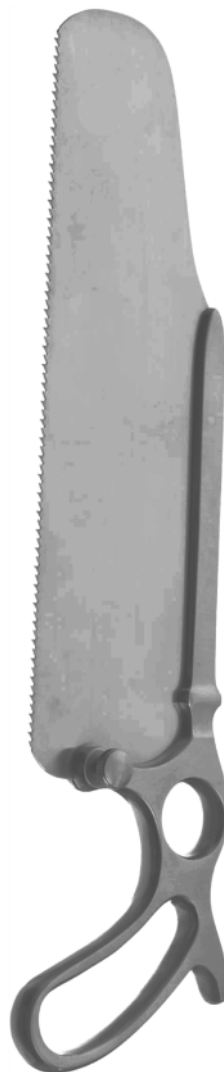

EI-018-29
Satterlee Amputation Saw Complete
With Saw Blade Ref: EI-018-90
Overall Length 29 cm (11 1/2")



EI-018-90
Satterlee Saw Blade

Reamer
Reibahlen
Escariadores
Pointes-carrées
Punteruoli



EI-020-00
Handheld Bone Mill



EI-022-00
Champhy Bone Biopsy (Instruments Set Consisting of Trocar)
Toothed Trepine And A Plunger Reamer
Overall Length 22 cm (8 1/2")

Reamer, Hand Drills
Reibahlen
Escariadores, Perforadores de mano
Pointes-carrées, Perforateurs à main
Punteruoli, Perforatori a mano



EI-024-13
Bone Reamer
Overall Length 13.5 cm (5 ¼")



EI-0EI-18
Perthes Bone Reamer
Overall Length 18 cm (7")



EI-028-21
Perthes Bone Reamer
Overall Length 21.5 cm (8 ½")

EVA

BONE SURGERY



EI-030-14
Bone Reamer
Overall Length 14 cm (5 ½")



EI-034-00
Drill Handle with Chuck
T-Form, With Key Ref: EI-034-90



EI-034-90
Key

Hand Drills
Handbohrapparate
Perforadores de mano
Perforateurs à main
Perforatori a mano



EI-0EI-00
Drill Handle With Chuck
Longitudinally Bored
With Key Ref: EI-0EI-90



EI-0EI-90
Key

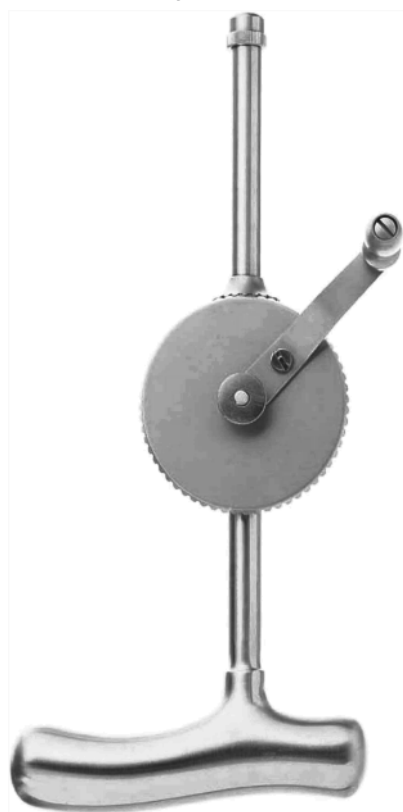

EI-040-00
Stille-Sherman Drill Handle Complete
With Twist Drill Ref: EI-044-01 to EI-044-03
Overall Length 25 cm (9 3/4")

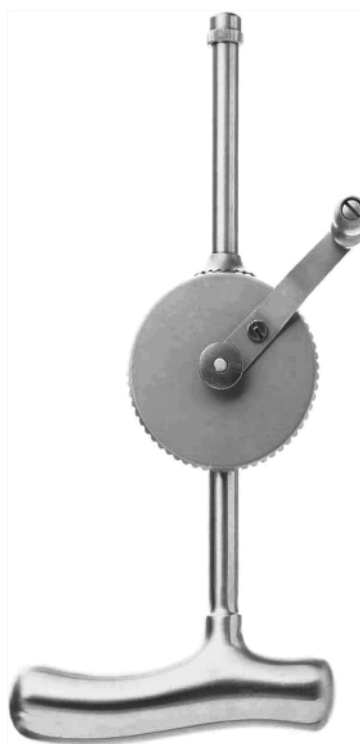

EI-042-00
Stille Drill Handle Complete
With Twist Drill Ref: EI-044-01 to EI-044-03
Overall Length 20.5 cm (8")



Hand Drills
Handbohrapparate
Perforadores de mano
Perforateurs à main
Perforatori a mano

EVA

BONE SURGERY



Twist Drill

EI-044-01
Ø 2.5 mm
Fig. 1

EI-044-02
Ø 3.0 mm
Fig. 2

EI-044-03
Ø 3.5 mm
Fig. 3

EI-044-04
Ø 4.0 mm
Fig. 4



EI-044-05
Trephine
Fig. 5, Ø 10.0 mm



EI-050-00
Hudson Hand Drill Complete
Complete With 4 Burs Ref:- EI-050-01 up to EI-050-04
& Extension Piece EI-050-09



Conical Burr

EI-050-01
Fig. 1
Ø 9.0 mm

EI-050-02
Fig. 1
Ø 14.0 mm



Spherical Burr

EI-050-03
Fig. 3
Ø 16.0 mm

EI-050-04
Fig. 4
Ø 22.0 mm



EI-050-05
Cushing Flat Trephine
Fig. 5, Ø 14.0 mm



EI-050-07
McKenzie Burr
Fig. 7, Ø 13.0 mm



EI-050-09
Extension Piece

Hand Drills
Handbohrapparate
Perforadores de mano
Perforateurs à main
Perforatori a mano



EI-054-00
Moore Handle Drill (Complete)
With A Set of Twist Drill Ref: EI-053-03



EI-053-03
Twist Drill
Set of 3
(2 Pcs (Ø 3.2 x 70 mm and
1 Pcs Ø 3.2 mm x 90 mm)



EI-058-00
Martin Handle Drill (Complete)
With Jacobs With Ref: EI-588-91 and EI-058-92

Twist Drill, Hand Drills
Spiralbohrer, Handbohrapparate
Broca espiral, Perforadores de mano
Mèche hélicoïdale, Perforateurs à main
Punte a spirale, Perforatori a mano

EVA

RETRACTORS



EI-070-10 Ø 1.0 mm	EI-070-32 Ø 3.2 mm
EI-070-15 Ø 1.5 mm	EI-070-35 Ø 3.5 mm
EI-070-20 Ø 2.0 mm	EI-070-40 Ø 4.0 mm
EI-070-25 Ø 2.5 mm	EI-070-45 Ø 4.5 mm
EI-070-28 Ø 2.8 mm	EI-070-50 Ø 5.0 mm
EI-070-30 Ø 3.0 mm	EI-070-60 Ø 6.0 mm

Twist Drill
Smooth Shaft



EI-094-00
Bunnell Hand Drill
Longitudinally Bored With 3 Jaws Chuck and Key,
Light Metal Housing Opening up to Ø 4.0 mm



EI-096-00
Ralk Hand Drill
Longitudinally Bored With 3 Jaws Chuck and Key,
Light Metal Housing Opening up to Ø 4.0 mm

Screw Driver, Wire Guides
 Handbohrapparate, Drahtumführungsadeln
 Perforadores de mano, Agujas pasa-hilo
 Perforateurs à main, Aiguilles passe-fils
 Perforatori a mano, Aghi passafili



FiberGrip™ Screw Driver
 Overall Length 25 cm (10")

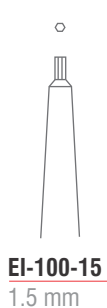

EI-100-15
 1.5 mm



EI-100-25
 2.5 mm



EI-100-35
 3.5 mm

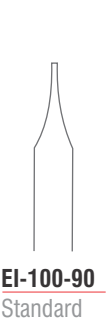

EI-100-90
 Standard



EI-100-91
 Standard

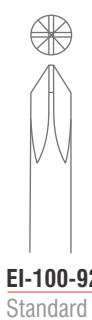

EI-100-92
 Standard



Demel Wire Guide

EI-101-01
 Fig. 1
 31 cm (12 1/4")

EI-101-02
 Fig. 2
 29 cm (11 1/2")

EI-101-03
 Fig. 3
 28 cm (11")



EI-103-18
FiberGrip™ Suture Passer
 Overall Length 18.5 cm (7")



Wire Tightener, Extension Bows
 Drahtspanner, Extensionsbügel
 Tensor cierra-hilo, Estribos para extensión
 Tendeur serre-fil, Etriers à extension
 Strumento tendifili, Archi per estensione

BONE SURGERY



EI-104-21
Loute Wire Tightener
 Overall Length 21 cm (8 1/4")



EI-106-27
Demel Wire Tightener and Twister
 Overall Length 27 cm (10 3/4")

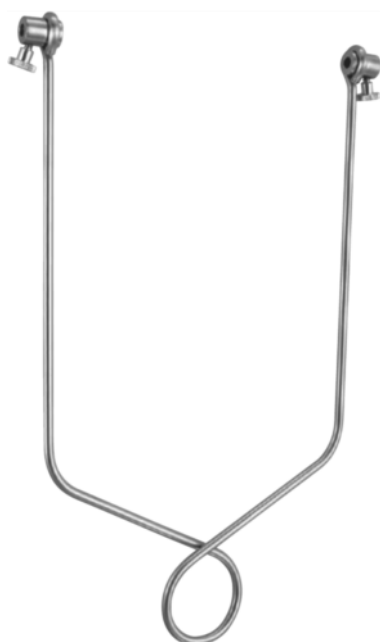

Bohler Extension Bows

EI-110-15
 210 x 150 mm
 For Femur and Knee

EI-110-16
 160 x 90 mm
 For Arm

EI-110-21
 210 x 110 mm
 For Femur and Knee



Kirschner Extension Bows
 With 3 Traction Hooks

EI-114-01
 90 x 70 mm
 For Children

EI-114-02
 105 x 105 mm
 For Wrist and Ankle

EI-114-03
 120 x 120 mm
 For Elbow

EI-114-04
 155 x 155 mm
 For Knee

EI-114-05
 200 x 155 mm
 For Femur

Extension Bows
 Extensionsbügel
 Estribos para extensión
 Etriers à extension
 Archi per estensione



EI-116-01
 Small Pattern
 18.5 cm (7 1/4")

EI-116-02
 Large Pattern
 26.5 cm (10 1/2")

Kirschner Extension Bows
 With 3 Traction Hooks

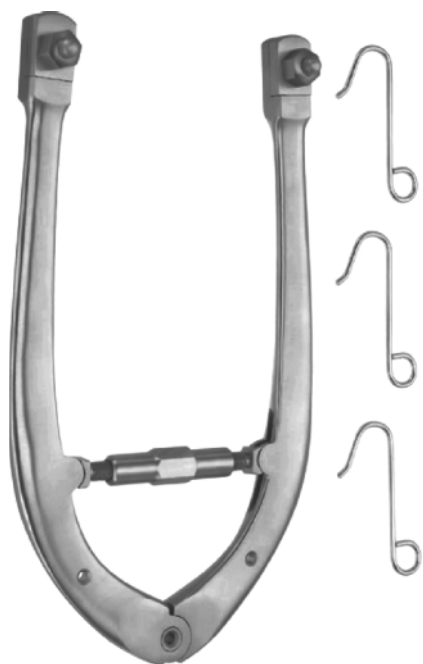

Extension Bows



EI-118-18
Wire Strainer
 For Ref: EI-581-01 up to EI-581-05
 Overall Length 18.5 cm (7 1/4")

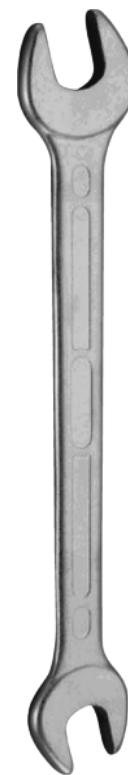

EI-120-20
Wrench
 Overall Length 20 cm (8")

EI-122-18
 180 x 100 mm (7" x 4")

EI-122-27
 270 x 160 mm (10 1/2" x 6 1/4")

Wire Twisting Forceps
Drahtwirbelzangen
Pinzas para torcer alambre
Pinces à torsader le fil
Pinze per ritorcere fili

EVA

BONE SURGERY



Bone Holding Clamp
Drahtwirbelzangen
Pinzas para torcer alambre
Pinces à torsader le fil
Pinze per ritorcere fili



Gerster-Lowman Bone Holding Clamp

EI-160-12
12 cm (4 3/4")

EI-160-18
18 cm (7")

EI-160-20
20 cm (8")

EI-160-22
22 cm (8 3/4")



EI-162-15
Gerster Traction Bar



LowmEI-Hoglund Bone Holding Clamp

EI-164-18
18.5 cm (7 1/4")

EI-164-20
20 cm (8")



LowmEI-Lambert Bone Holding Clamp

EI-166-18
18.5 cm (7 1/4")

EI-166-20
20 cm (8")

Wire Twisting Forceps
Drahtzwirbelzangen
Pinzas para torcer alambre
Pinces à torsader le fil
Pinze per ritorcere fili



UltraGrip™ TC Wire Twisting Forcep

ULTRA GRIP



EI-170-15
15.5 cm (6")



EI-170-18
18 cm (7")



EI-172-15
15.5 cm (6")



EI-172-18
18 cm (7")



EI-1EI-15
15.5 cm (6")

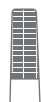

EI-1EI-18
18 cm (7")



EI-176-20
UltraGrip™ TC Baumgartner Wire Twisting Forcep
Overall Length 20 cm (8")

ULTRA GRIP



EI-177-15
UltraGrip™ TC Wire Twisting Forcep
Overall Length 14.5 cm (5 3/4")

ULTRA GRIP

Wire Twisting Forceps
 Drahtwirbelzangen
 Pinzas para torcer alambre
 Pinces à torsader le fil
 Pinze per ritorcere fili



EI-180-16
UltraGrip™ TC Corwin Wire Twisting Forcep
 Overall Length 16 cm (6 ¼")



EI-182-18
UltraGrip™ TC Combi Wire Twisting Forcep
 Overall Length 18.5 cm (7 ¼")



Wire Twisting Forceps, Flat Nose Pliers
 Drahtzwirbelzangen, Flachzangen
 Pinzas para torcer alambre, Alicates de pico plano
 Pincès à torsader le fil, Pincès plates
 Pinze per ritorcere fili, Tenaglie piatte



EI-184-19
UltraGrip™ TC Berry Wire Twisting Forcep
 Heavy Pattern, With Tungsten Carbide Inserts
 Overall Length 19 cm (7 ½")



EI-186-01

EI-186-02

EI-186-03

UltraGrip™ Combi-Flat Nose Plier
 Parallel Grip, Compound Action
 Overall Length 18 cm (8")



Flat Nose Pliers
Flachzangen
Alicates de pico plano
Pinces plates
Tenaglie piate



EI-190-14
Flat Nose Plier
Overall Length 13.5 cm (5 1/4")



EI-192-14
Flat Nose Plier
Overall Length 14 cm (5 1/4")



EI-194-14
Flat Nose Plier
Overall Length 14 cm (5 1/4")



EI-196-17
17.5 cm (7")

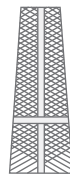

EI-198-17
With Crosswise Groove
17 cm (6 3/4")



EI-200-19
Flat Nose Plier
Pointed
Overall Length 19.5 cm (7 3/4")

Flat Nose Plier

Flat Nose Pliers
Flachzangen
Alicates de pico plano
Pinces plates
Tenaglie piatte



EI-202-16
Flat Nose Plier
With Longitudinal Groove
Overall Length 16 cm (6 1/4")

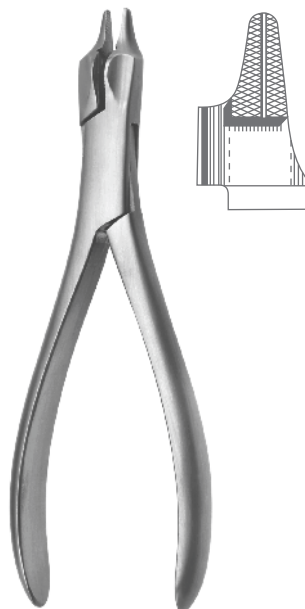

EI-204-15
Combi-Flat Nose Plier
For Bending and Cutting
Overall Length 15 cm (6")



EI-210-17
Flat Nose Plier
Parallel Grip
Overall Length 18.5 cm (7 1/4")



EI-212-18
Vise Grip Plier
Overall Length 20.5 cm (8")

Flat Nose Pliers
Flachzangen
Alicates de pico plano
Pinces plates
Tenaglie piatte



Combi-Flat Nose Plier
Parallel Grip, Compound Action
Overall Length 18 cm (7")



EI-214-01

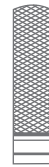

EI-214-02

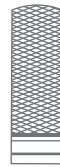

EI-214-03



EI-214-04
Flat Nose Plier
Overall Length 18 cm (7")

Wire Cutting Pliers
Drahtkneifzangen
Alicates para cortar alambre
Pinces à couper le fil
Tenaglie tagliafili



EI-220-18
Wire Cutting Plier
For Soft Wires Up to \varnothing 2.4 mm
For Hard Wires Up to \varnothing 1.8 mm
Overall Length 18.5 cm (7 ¼")



EI-222-16
Wire Cutting Plier
For Soft Wires Up to \varnothing 2.2 mm
For Hard Wires Up to \varnothing 2.0 mm
Overall Length 16 cm (6 ¼")

Wire Cutting Pliers
Drahtkneifzangen
Alicates para cortar alambre
Pinces à couper le fil
Tenaglie tagliafilii

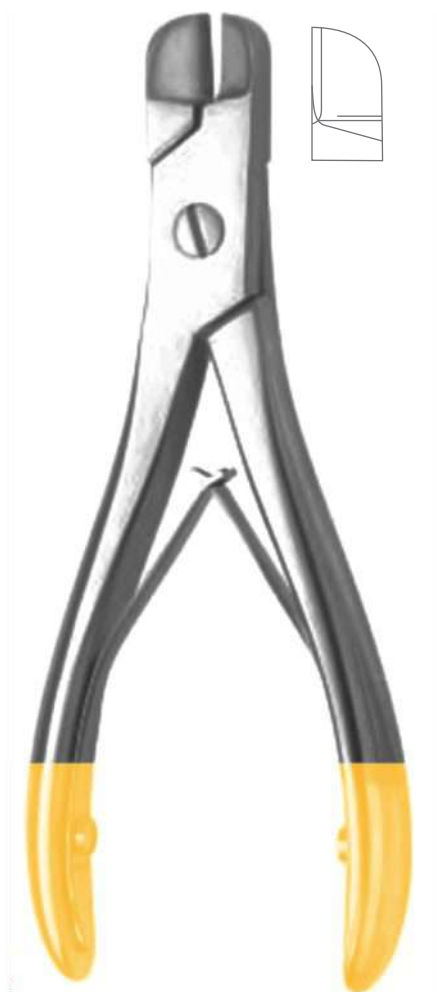

EI-230-13
UltraCut™ TC Wire Cutting Plier
For Soft Wires Up to Ø 1.5 mm
For Hard Wires Up to Ø 1.0 mm
Overall Length 13 cm (5 ¼")

ULTRACut™



EI-232-16
UltraCut™ TC Wire Cutting Plier
For Soft Wires Up to Ø 3.5 mm
For Hard Wires Up to Ø 2.5 mm
Overall Length 16.5 cm (6 ½")

ULTRACut™

Wire Cutting Pliers
Drahtkneifzangen
Alicates para cortar alambre
Pincès à couper le fil
Tenaglie tagliafili



EI-234-18
For Soft Wires Up to Ø 2.0 mm
For Hard Wires Up to Ø 1.7 mm
17.5 cm (7")

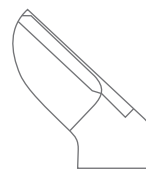

EI-234-22
For Soft Wires Up to Ø 2.8 mm
For Hard Wires Up to Ø 2.2 mm
22.5 cm (8 ¾")

UltraCut™ TC Wire Cutting Plier

ULTRA *Cut*™



EI-2EI-23
UltraCut™ TC Wire Cutting Plier
For Soft Wires Up to Ø 3.0 mm, For Hard Wires Up to Ø 2.2 mm
Overall Length 23 cm (9")

ULTRA *Cut*™



EI-238-15
UltraCut™ TC Wire Cutting Plier
For Soft Wires Up to Ø 2.0 mm
For Hard Wires Up to Ø 1.2 mm
Overall Length 15 cm (6")

ULTRA *Cut*™

Wire Cutting Pliers
 Drahtkneifzangen
 Alicates para cortar alambre
 Pincès à couper le fil
 Tenaglie tagliafilii



EI-238-22
UltraCut™ TC Wire Cutting Plier
 For Soft Wires Up to Ø 3.0 mm
 For Hard Wires Up to Ø 2.0 mm
 Overall Length 22 cm (8 ¾")

ULTRA.Cut™



EI-240-47
UltraCut™ TC Wire Cutting Plier/Plate Cutter
 For Wires Up to Ø 6 mm
 Overall Length 47 cm (18 ½")

ULTRA.Cut™

Autopsy Instruments
Autopsie Instrumente
Instrumentos para la autopsia
Instruments pour la autopsie
Strumenti per autopsia



EI-250-00
Virchow Skull Breaker
15 mm



EI-252-14
Skull Breaker
Overall Length 14 cm (5 1/2")



EI-254-22
Rachiotome
Overall Length 22 cm (8 3/4")



EI-255-18
Councilman's Chisel
Overall Length 18 cm (7")



EI-256-20
20 mm

EI-256-23
23 mm

Post Mortem Chisel
Overall Length 13 cm (5 1/4")



EI-258-01
Left

EI-258-02
Right

Brunetti Post Mortem Chisel
Overall Length 28.5 cm (11 1/4")

Bone Chisels, Gouges
Knochenmeißel, Hohlmeißel
Cinceles, Gubias
Ciseaux-burins, Gouges
Scalpelli, Sgorbie



EI-260-24
Post Mortem Hammer
With Hook Handle
Overall Length 24 cm (9 1/2")



EI-280-04
Bone Chisel
4.0 mm
Overall Length 17 cm (6 3/4")



EI-282-04
Bone Osteotome
4.0 mm
Overall Length 17 cm (6 3/4")

Bone Chisels, Gouges
Knochenmeißel, Hohlmeißel
Cinceles, Gubias
Ciseaux-burins, Gouges
Scalpelli, Sgorbie



Gardner Bone Chisel
Triangular Shape
Overall Length 17 cm (6 3/4")

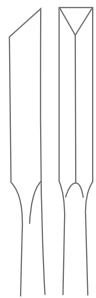

EI-284-01
Straight
4.0 mm



EI-284-02
Curved Right
4.0 mm



EI-284-02
Curved Left
4.0 mm



Snyder-O.S.U Bone Gouge
Overall Length 16.5 cm (6 1/2")



















EI-286-03
3.0 mm



EI-286-05
5.0 mm







Bone Chisels, Gouges
Knochenmeißel, Hohlmeißel
Cinceles, Gubias
Ciseaux-burins, Gouges
Scalpelli, Sgorbie



			
	EI-300-08 8.0 mm	EI-301-08 8.0 mm	EI-302-08 8.0 mm
			
	EI-300-10 10.0 mm	EI-301-10 10.0 mm	EI-302-10 10.0 mm
			
	EI-300-12 12.0 mm	EI-301-12 12.0 mm	EI-302-12 12.0 mm
			
	EI-300-14 14.0 mm	EI-301-14 14.0 mm	EI-302-14 14.0 mm
			
	EI-300-16 16.0 mm	EI-301-16 16.0 mm	EI-302-16 16.0 mm
Bone Osteotome Overall Length 13.5 cm (5 1/4")	Bone Chisel Overall Length 13.5 cm (5 1/4")	Bone Gouge Overall Length 13.5 cm (5 1/4")	





Bone Chisels, Gouges
Knochenmeißel, Hohlmeißel
Cinceles, Gubias
Ciseaux-burins, Gouges
Scalpelli, Sgorbie



-  **EI-305-02**
2.0 mm
-  **EI-305-03**
3.0 mm
-  **EI-305-04**
4.0 mm
-  **EI-305-05**
5.0 mm
-  **EI-305-06**
6.0 mm
-  **EI-305-07**
7.0 mm
-  **EI-305-08**
8.0 mm





Partsch Bone Chisel
Overall Length 13.5 cm (5 1/4")



-  **EI-306-02**
2.0 mm
-  **EI-306-03**
3.0 mm
-  **EI-306-04**
4.0 mm
-  **EI-306-05**
5.0 mm
-  **EI-306-06**
6.0 mm
-  **EI-306-07**
7.0 mm
-  **EI-306-08**
8.0 mm



Partsch Bone Chisel
Overall Length 17 cm (6 3/4")



-  **EI-309-02**
2.0 mm
-  **EI-309-03**
3.0 mm
-  **EI-309-04**
4.0 mm
-  **EI-309-05**
5.0 mm
-  **EI-309-06**
6.0 mm
-  **EI-309-07**
7.0 mm
-  **EI-309-08**
8.0 mm

Partsch Bone Gouge
Overall Length 13.5 cm (5 1/4")



-  **EI-310-02**
2.0 mm
-  **EI-310-03**
3.0 mm
-  **EI-310-04**
4.0 mm
-  **EI-310-05**
5.0 mm
-  **EI-310-06**
6.0 mm
-  **EI-310-07**
7.0 mm
-  **EI-310-08**
8.0 mm

Partsch Bone Gouge
Overall Length 17 cm (6 3/4")

Bone Chisels, Gouges
Knochenmeißel, Hohlmeißel
Cinceles, Gubias
Ciseaux-burins, Gouges
Scalpelli, Sgorbie



Alexander Bone Chisel
Overall Length 17.5 cm (7")

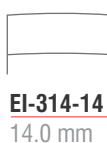
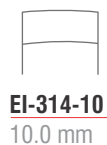
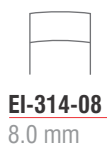

Alexander Bone Gouge
Overall Length 17.5 cm (7")

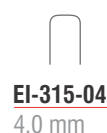

Osteotomes
Osteotome
Osteótomos
Ostéotomes
Osteotomi



Mini-Lambotte Bone Osteotome
Straight
Overall Length 12.5 cm (5")

Mini-Lambotte Bone Osteotome
Straight
Overall Length 17 cm (6 ¾")

Osteotomes
Osteotome
Osteótomos
Ostéotomes
Osteotomi

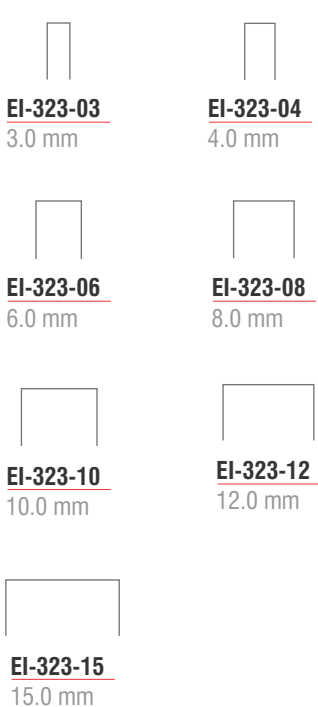

Mini-Lambotte Bone Osteotome
Curved
Overall Length 17 cm (6 3/4")

Osteotomes
Osteotome
Osteótomos
Ostéotomes
Osteotomi



EI-324-04
4.0 mm



EI-324-25
25.0 mm



EI-324-08
8.0 mm



EI-324-30
30.0 mm



EI-324-10
10.0 mm



EI-324-38
38.0 mm



EI-324-13
13.0 mm



EI-324-44
44.0 mm



EI-324-15
15.0 mm



EI-324-50
50.0 mm



EI-324-20
20.0 mm

Lambotte Bone Osteotome
Straight
Overall Length 24 cm (9 1/2")

Osteotomes
Osteotome
Osteótomos
Ostéotomes
Osteotomi



EI-325-04
4.0 mm



EI-325-08
8.0 mm



EI-325-10
10.0 mm



EI-325-13
13.0 mm



EI-325-15
15.0 mm



EI-325-20
20.0 mm



EI-325-25
25.0 mm



EI-325-30
30.0 mm



EI-325-38
38.0 mm

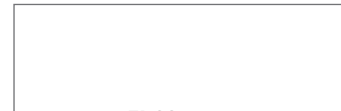

EI-325-44
44.0 mm



EI-325-50
50.0 mm

Lambotte Bone Osteotome
Curved
Overall Length 24 cm (9 1/2")

Chisels, Osteotomes
 Flachmeißel, Osteotome
 Cinceles, Osteótomos
 Ciseaux-burins, Ostéotomes
 Scalpelli, Osteotomi



Stille Bone Chisel
 Overall Length 20 cm (8")

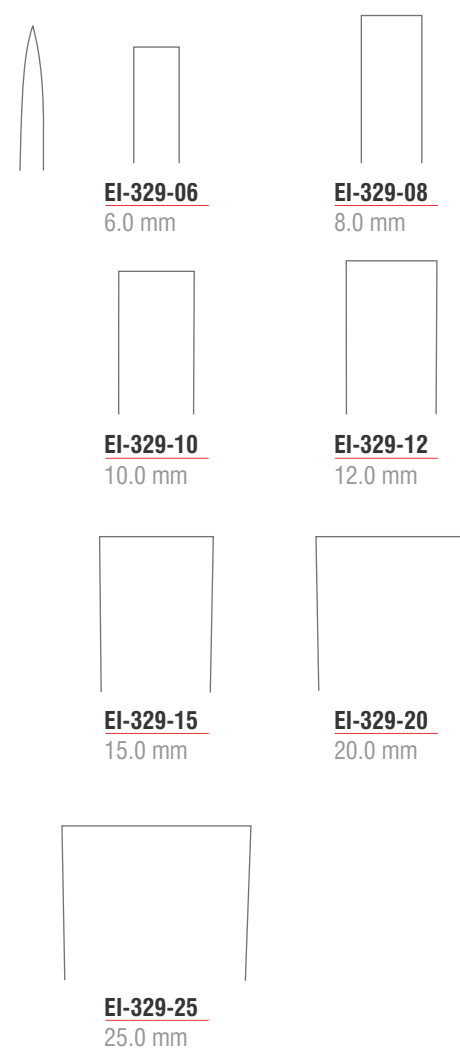

Stille Bone Osteotome
 Overall Length 20 cm (8")

Gouges
Hohlmeißel
Gubias
Gouges
Sgorbie



Stille Bone Gouge
Overall Length 20 cm (8")



EI-330-06
6.0 mm



EI-330-08
8.0 mm



EI-330-10
Curved



EI-330-12
Curved

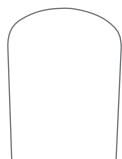

EI-330-15
Curved



EI-330-20
Curved



EI-330-25
Curved

Osteotomes
Osteotome
Osteótomos
Ostéotomes
Osteotomi



Smith-Peterson Bone Osteotome
Straight
Overall Length 20.5 cm (8")

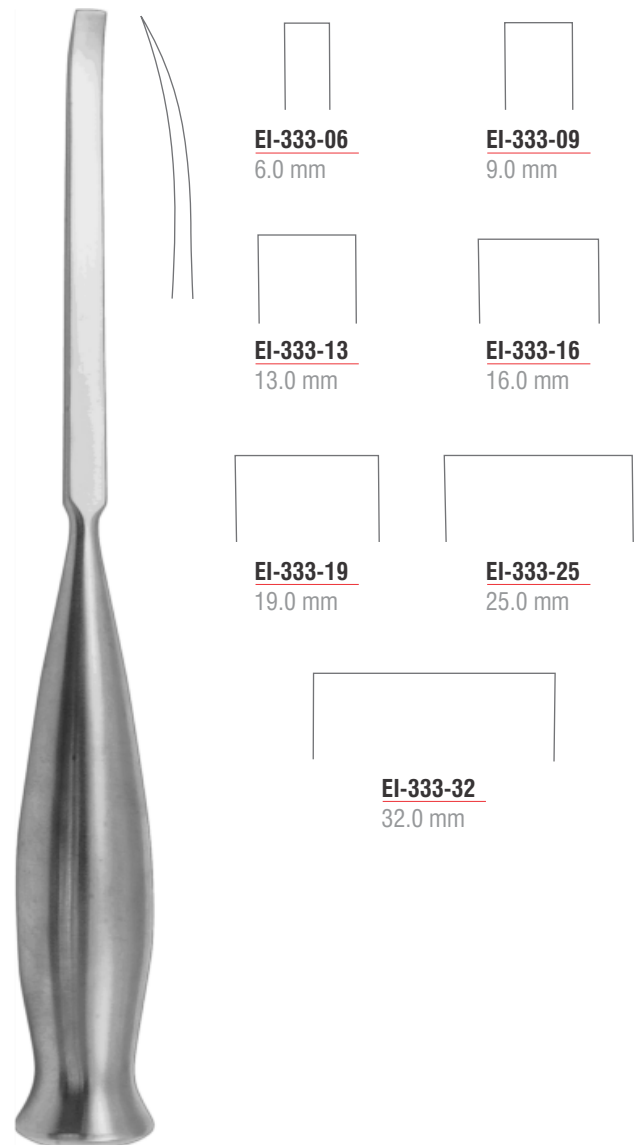

Smith-Peterson Bone Osteotome
Curved
Overall Length 20.5 cm (8")

Gouges
Hohlmeißel
Gubias
Gouges
Sgorbie



Smith-Peterson Bone Gouge
Straight
Overall Length 20.5 cm (8")

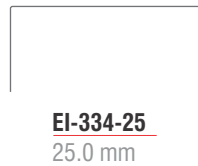

Smith-Peterson Bone Gouge
Curved
Overall Length 20.5 cm (8")

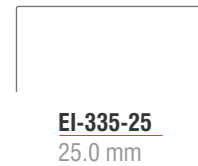

Osteotomes
 Osteotome
 Osteótomos
 Ostéotomes
 Osteotomi

		EI-338-03 3.0 mm			EI-340-06 6.0 mm			EI-341-06 6.0 mm
		EI-338-05 5.0 mm			EI-340-13 13.0 mm			EI-341-13 13.0 mm
		EI-338-06 6.0 mm			EI-340-19 19.0 mm			EI-341-19 19.0 mm
		EI-338-08 8.0 mm			EI-340-25 25.0 mm			EI-341-25 25.0 mm
		EI-338-09 9.0 mm			EI-340-32 32.0 mm			EI-341-32 32.0 mm
Hoke Bone Osteotome Overall Length 17 cm (6 3/4")			Hibbs Bone Osteotome Straight Overall Length 24.5 cm (9 3/4")			Hibbs Bone Osteotome Curved Overall Length 24.5 cm (9 3/4")		

Chisels, Gouges
Flachmeißel, Hohlmeißel
Cinceles, Gubias
Ciseaux-burins, Gouges
Scalpell, Sgorbie

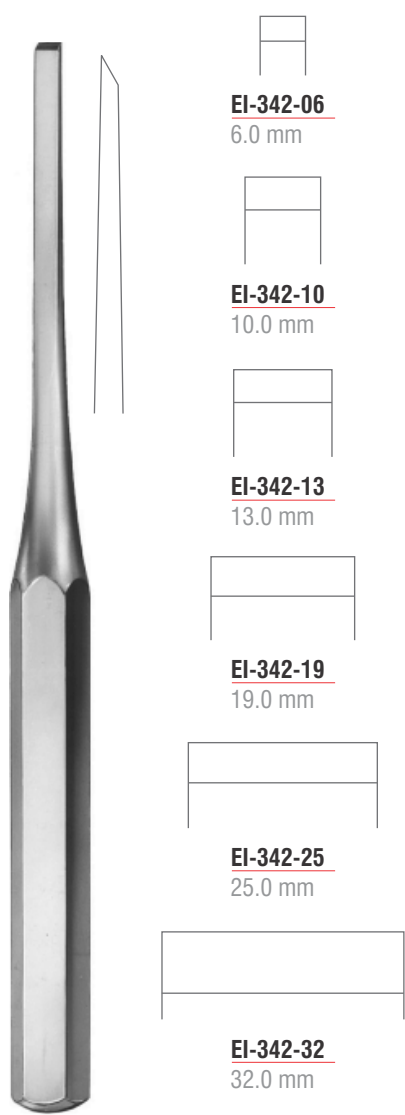

Hibbs Bone Chisel
Overall Length 24.5 cm (9 3/4")

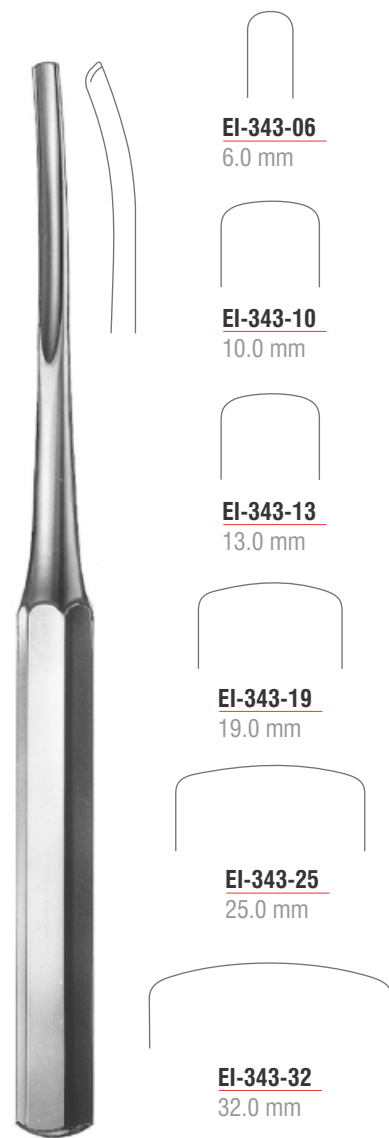

Hibbs Bone Gouge
Curved
Overall Length 24.5 cm (9 3/4")

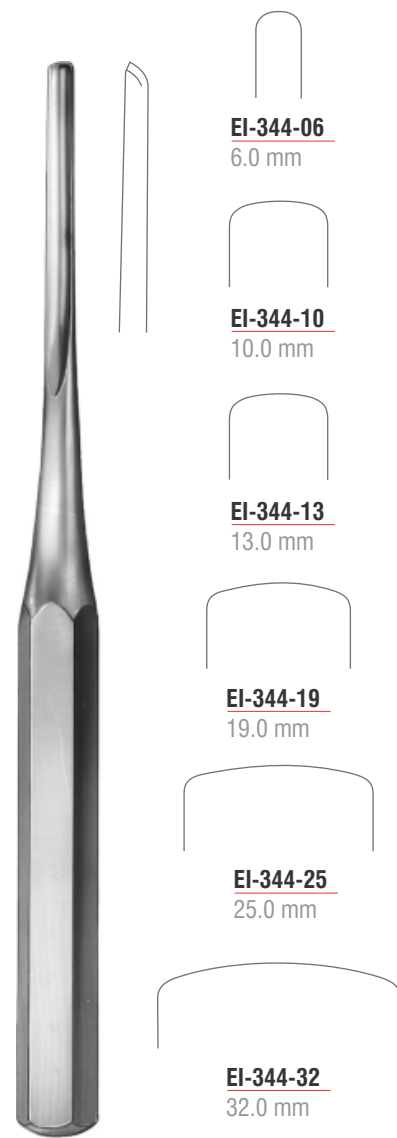

Hibbs Bone Gouge
Straight
Overall Length 24.5 cm (9 3/4")

Gouges, Osteotomes
Hohlmeißel, Osteotome
Gubias, Osteótomos
Gouges, Ostéotomes
Sgorbie, Osteotomi

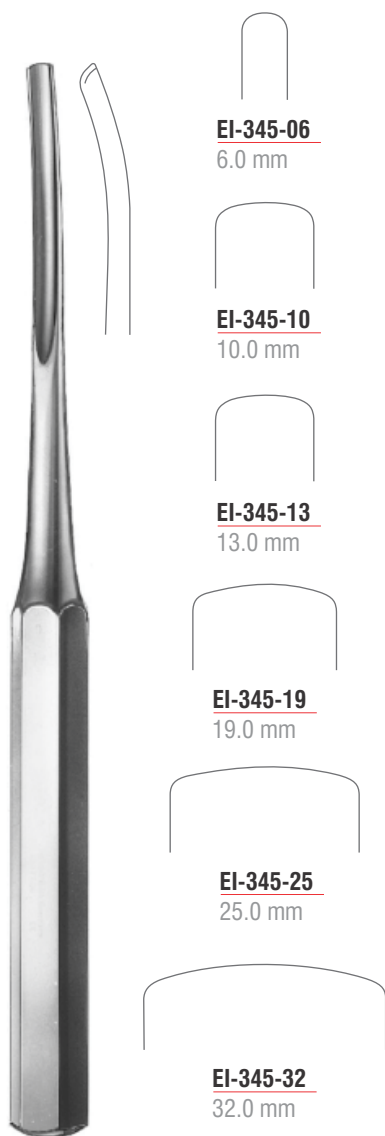

Hibbs Bone Gouge
Curved
Overall Length 24.5 cm (9 3/4")



Cloward Bone Osteotome
Overall Length 24.5 cm (9 3/4")

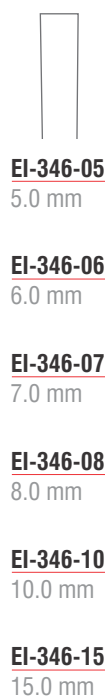

EI-346-15
15.0 mm



Cloward Bone Gouge
Overall Length 24.5 cm (9 3/4")

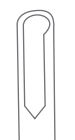

EI-348-15
15.0 mm

Gouges, Osteotomes
Hohlmeißel, Osteotome
Gubias, Osteótomos
Gouges, Ostéotomes
Sgorbie, Osteotomi



EI-356-05
5.0 mm

EI-356-10
10.0 mm

EI-356-15
15.0 mm

FiberGrip™ Lexer Bone Gouge
Straight
Overall Length 25 cm (9 3/4")



EI-357-05
5.0 mm

EI-357-10
10.0 mm







EI-357-15
15.0 mm

FiberGrip™ Lexer Bone Gouge
Curved
Overall Length 25 cm (9 3/4")









Osteotomes, Gouges
 Osteotome, Hohlmeißel
 Osteótomos, Gubias
 Ostéotomes, Gouges
 Osteotomi, Sgorbie



- 
EI-360-02
2.0 mm
- 
EI-360-04
4.0 mm
- 
EI-360-06
6.0 mm
- 
EI-360-08
8.0 mm
- 
EI-360-10
10.0 mm
- 
EI-360-12
12.0 mm

FiberGrip™ Mini-Lexer Bone Osteotome
 Overall Length 18.5 cm (7 ¼")



- 
EI-362-02
2.0 mm
- 
EI-362-04
4.0 mm
- 
EI-362-06
6.0 mm
- 
EI-362-08
8.0 mm
- 
EI-362-10
10.0 mm
- 
EI-362-12
12.0 mm

FiberGrip™ Mini-Lexer Bone Gouge
 Overall Length 18.5 cm (7 ¼")



Chisels, Osteotomes
 Flachmeißel, Osteotome
 Cinceles, Osteótomos
 Ciseaux-burins, Ostéotomes
 Scalpelli, Osteotomi



- EI-364-10**
10.0 mm
- EI-364-15**
15.0 mm
- EI-364-20**
20.0 mm
- EI-364-25**
25.0 mm
- EI-364-30**
30.0 mm

FiberGrip™ Lexer Bone Chisel
 Straight
 Overall Length 20 cm (8")



- EI-365-10**
10.0 mm
- EI-365-15**
15.0 mm
- EI-365-20**
20.0 mm

FiberGrip™ Lexer Bone Chisel
 Curved
 Overall Length 20 cm (8")



- EI-366-07**
7.0 mm
- EI-366-10**
10.0 mm
- EI-366-15**
15.0 mm
- EI-366-20**
20.0 mm
- EI-366-25**
25.0 mm
- EI-366-30**
30.0 mm

FiberGrip™ Lexer Bone Osteotome
 Overall Length 22 cm (8 3/4")



Gouges, Osteotomes
Hohlmeißel, Osteotome
Gubias, Osteótomos
Gouges, Ostéotomes
Sgorbie, Osteotomi



FiberGrip™ Lexer Bone Gouge
Overall Length 22 cm (8 3/4")



FiberGrip™ Lexer Bone Osteotome Angled
Overall Length 27.5 cm (10 3/4")



FiberGrip™ Lexer Bone Gouge Angled
Overall Length 27.5 cm (10 3/4")



Chisels, Gouges
Flachmeißel, Hohlmeißel
Cinceles, Gubias
Ciseaux-burins, Gouges
ScalPELLI, Sgorbie



EI-376-24
FiberGrip™ Bone Chisel
20 mm
Overall Length 24.5 cm (9 3/4")



EI-377-26
FiberGrip™ Bone Chisel
Curved, 16.0 mm
Overall Length 26.5 cm (10 1/2")



FiberGrip™ Wagner Bone Gouge
Overall Length 34 cm (13 1/2")

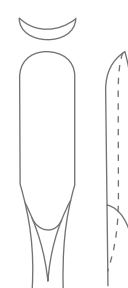

EI-390-09
Straight
9.0 mm

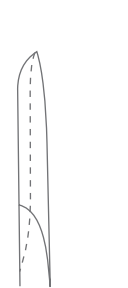

EI-390-15
Straight
15.0 mm



EI-391-09
Curved Forward
9.0 mm

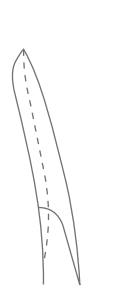

EI-391-15
Curved Forward
15.0 mm



EI-393-09
Curved Backward
9.0 mm

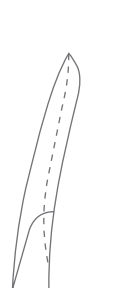

EI-393-15
Curved Backward
15.0 mm

EI-393-20
Curved Backward
20.0 mm

Gouges
Hohlmeißel
Gubias
Gouges
Sgorbie



EI-395-29
FiberGrip™ Bone Gouge
25 mm
Overall Length 25 cm (9 3/4")



EI-398-28
FiberGrip™ Cobb Bone Gouge
8.0 mm
Overall Length 28 cm (11")



FiberGrip™ Cobb Bone Gouge
Overall Length 28 cm (11")



EI-399-01
8.0 mm

EI-399-02
8.0 mm

EI-399-03
8.0 mm

Gouges
Hohlmeißel
Gubias
Gouges
Sgorbie

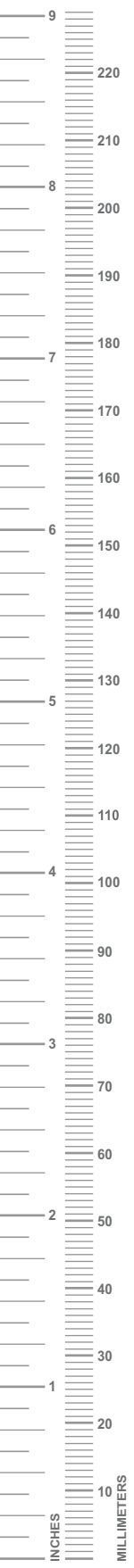

EI-402-22
FiberGrip™ Bone Gouge
9.0 mm
Overall Length 22 cm (8 3/4")



EI-405-55
5.5 mm
23 cm (9")
EI-405-90
9.0 mm
23.5 cm (9 1/4")

FiberGrip™ Zielke Bone Gouge



EI-407-06
6.0 mm
EI-407-08
8.0 mm
EI-407-11
11.0 mm
EI-407-16
16.0 mm

FiberGrip™ Zielke Bone Gouge
Overall Length 23.5 cm (9 1/4")



Osteotomes
Osteotome
Osteótomos
Ostéotomes
Osteotomi



- | | |
|------------------------------------|------------------------------------|
| <u>EI-410-04</u>
4.0 mm | <u>EI-410-12</u>
12.0 mm |
| <u>EI-410-05</u>
5.0 mm | <u>EI-410-15</u>
15.0 mm |
| <u>EI-410-06</u>
6.0 mm | <u>EI-410-20</u>
20 mm |
| <u>EI-410-08</u>
8.0 mm | <u>EI-410-22</u>
22 mm |
| <u>EI-410-10</u>
10.0 mm | <u>EI-410-25</u>
25 mm |

FiberGrip™ Dahmen Bone Osteotome
Straight
Overall Length 30 cm (12")



- | | |
|------------------------------------|------------------------------------|
| <u>EI-411-04</u>
4.0 mm | <u>EI-411-12</u>
12.0 mm |
| <u>EI-411-05</u>
5.0 mm | <u>EI-411-15</u>
15.0 mm |
| <u>EI-411-06</u>
6.0 mm | <u>EI-411-20</u>
20 mm |
| <u>EI-411-08</u>
8.0 mm | <u>EI-411-22</u>
22 mm |
| <u>EI-411-10</u>
10.0 mm | <u>EI-411-25</u>
25 mm |

FiberGrip™ Dahmen Bone Osteotome
Curved
Overall Length 30 cm (12")



Gouges
Hohlmeißel
Gubias
Gouges
Sgorbie



- | | |
|-----------------------------|-----------------------------|
| EI-412-04
4.0 mm | EI-412-12
12.0 mm |
| EI-412-05
5.0 mm | EI-412-15
15.0 mm |
| EI-412-06
6.0 mm | EI-412-20
20 mm |
| EI-412-08
8.0 mm | EI-412-22
22 mm |
| EI-412-10
10.0 mm | EI-412-25
25 mm |

FiberGrip™ Dahmen Bone Gouge
Straight
Overall Length 30 cm (12")

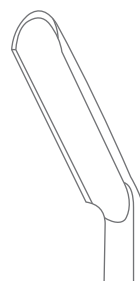

- | | |
|-----------------------------|-----------------------------|
| EI-413-04
4.0 mm | EI-413-12
12.0 mm |
| EI-413-05
5.0 mm | EI-413-15
15.0 mm |
| EI-413-06
6.0 mm | EI-413-20
20 mm |
| EI-413-08
8.0 mm | EI-413-22
22 mm |
| EI-413-10
10.0 mm | EI-413-25
25 mm |

FiberGrip™ Dahmen Bone Gouge
Curved
Overall Length 30 cm (12")



Bone Files
Knochenfeilen
Limas para huesos
Limes à os
Lime per ossa



EI-421-30
Putti Bone Rasp
Curved, Straight
Overall Length 30 cm (11 3/4")

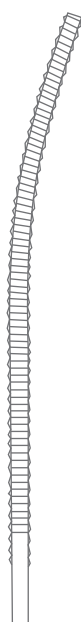

EI-423-27
Putti Bone Rasp
Curved, Round
Overall Length 27 cm (10 3/4")



EI-4EI-28
Bone File
Semi Round
Overall Length 28 cm (11")

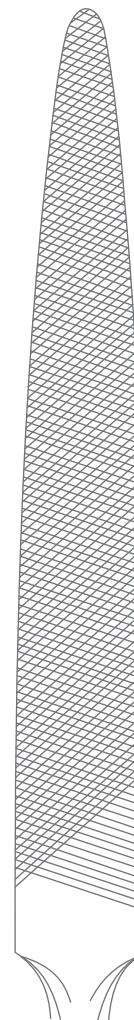

Bone Files, Tampers
Knochenfeilen, Stößel
Limas para huesos, Punzones metálicos
Limes à os, Pçons métalliques
Lime per ossa, Pestoni metallici



EI-427-24
Bone File
Semi Round
Overall Length 24.5 cm (9 3/4")



EI-430-22
Bone File
Flat
Overall Length 22 cm (8 3/4")

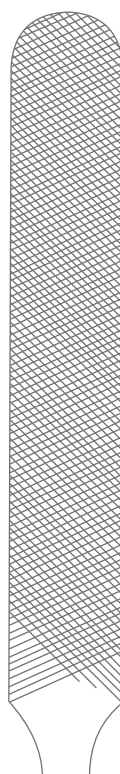

EI-438-25 2.5 mm
EI-438-35 3.5 mm

Passow Bone Tamper
Overall Length 12 cm (4 3/4")

Tampers
Stößel
Punzones metálicos
Pilons métalliques
Pestoni metallici



Bone Tamper
Overall Length 15 cm (6")

Caspar Bone Tamper
Overall Length 20 cm (8")

Bone Tamper
Overall Length 20 cm (8")



Tampers, Mallets
 Stößel, Hämmer
 Punzones metálicos, Martillos
 Pions métalliques, Maillets
 Pestoni metallici, Martelli



EI-446-16
Woerrlein Bone Tamper
 Cannulated
 Overall Length 16.5 cm (6 1/2")



EI-450-01
 Ø 26.0 mm
 300 Grams

EI-450-02
 Ø 28.0 mm
 340 Grams

EI-450-01
 Ø 30.0 mm
 400 Grams

Williger Bone Mallet
 Lead Filled
 Overall Length 24 cm (9 1/2")



EI-452-01
 Ø 25.0 mm
 120 Grams
 20.5 cm (8")

EI-452-02
 Ø 30.0 mm
 180 Grams
 21 cm (8 1/4")

EI-452-03
 Ø 30.0 mm
 260 Grams
 21 cm (8 1/4")

Doyen Bone Mallet

Mallets
Hämmer
Martillos
Maillets
Martelli



EI-454-20
Collin Bone Mallet
Ø 30.0 mm, 220 Grams
Overall Length 20 cm (8")



EI-458-21
Hajek Bone Mallet
Ø 27.0 mm, 140 Grams
Overall Length 21.5 cm (8 ½")



EI-460-17
Gerzog Bone Mallet
Ø 25.0 mm, 225 Grams
Overall Length 19 cm (7 ½")



EI-462-01
Ø 19.0 mm
230 Grams

EI-462-02
Ø 25.0 mm
260 Grams

Lucae Bone Mallet
Overall Length 19.5 cm (7 ¾")



EI-464-24
Bergmann Bone Mallet
Ø 45.0 mm, 300 Grams
Overall Length 24 cm (9 ½")

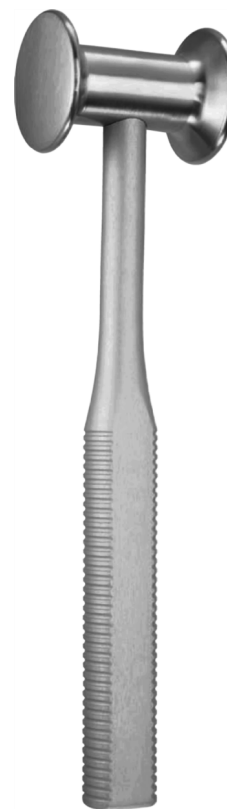

EI-466-24
Bergmann Bone Mallet
Ø 30.0 mm, 245 Grams
Overall Length 23.5 cm (9 ¼")

Mallets
Hämmer
Martillos
Maillets
Martelli



EI-468-24
FiberGrip™ Bone Mallet
Ø 30.0 mm, Ø 42.0 mm, 285 Grams
Overall Length 24 cm (9 ½")



EI-470-19
Cottle Bone Mallet
Plain, Convex, Ø 30.0 mm, 300 Grams
Overall Length 19 cm (7 ½")

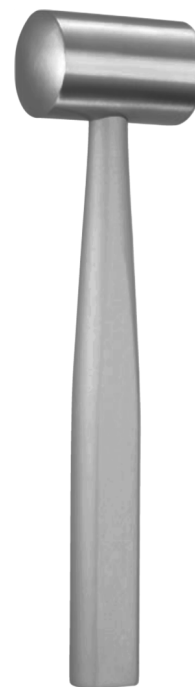

EI-472-24
Omberdanne Bone Mallet
Ø 40.0 mm, 520 Grams
Overall Length 24 cm (9 ½")



EI-4EI-18
Ø 40.0 mm
660 Grams
18.5 cm (7 ¼")

EI-4EI-20
Ø 45.0 mm
725 Grams
20 cm (8")

Heath Bone Mallet



EI-476-16
Williger Bone Mallet
Ø 20.0 mm, 140 Grams
Overall Length 16.5 cm (6 ½")



EI-4EI-19
Mead Bone Mallet
With Interchangeable Plastic Discs
Ø 27.0 mm, 320 Grams
Overall Length 19 cm (7 ½")

Mallets
Hämmer
Martillos
Maillets
Martelli



EI-4EI-90
Mallet Spare Plastic Discs
Pair, Plastic



EI-480-18
Partsch Mallet
With Hollow Handle, Ø 22.0 mm, 200 Grams
Overall Length 19 cm (7 ½")



EI-486-22
FiberGrip™ Bone Mallet
With Plastic Handle, Ø 30.0 mm, 510 Grams
Overall Length 26 cm (10 ¼")



EI-488-01
FiberGrip™ Bone Mallet
With Lead Filling, Ferrozell
Ø 42.0 mm, 400 Grams
Overall Length 26 cm (10 ¼")



EI-488-02
FiberGrip™ Bone Mallet
Without Lead Filling, Ferrozell
Ø 42.0 mm, 250 Grams
Overall Length 26 cm (10 ¼")



EI-490-26
FiberGrip™ Bone Mallet
With Lead Filling, Ferrozell
Ø 42.0 mm, 400 Grams
Overall Length 26 cm (10 ¼")

Mallets
Hämmer
Martillos
Maillets
Martelli



EI-492-29
FiberGrip™ Bone Mallet
Plane (Nylon), Convex (Stainless Steel)
Ø 30.0 mm, 675 Grams
Overall Length 26.5 cm (10 ½")



EI-494-24
FiberGrip™ Bone Mallet
Plane (Nylon), Convex (Stainless Steel)
Ø 30.0 mm, 530 Grams
Overall Length 26 cm (10 ¼")



EI-496-24
FiberGrip™ Bone Mallet
Ø 30.0 mm, 480 Grams
Overall Length 24 cm (9 ½")



EI-498-22
FiberGrip™ Bone Mallet
With Interchangeable Plastic Discs
Ø 37.0 mm, 370 Grams
Overall Length 24 cm (9 ½")



Mallets
Hämmer
Martillos
Maillets
Martelli



EI-500-18
FiberGrip™ Bone Mallet
Ø 30.0 mm, 125 Grams
Overall Length 22 cm (8 ¾")



EI-502-01
Ø 30.0 mm, 450 Grams

EI-502-02
Ø 50.0 mm, 900 Grams



FiberGrip™ Bone Mallet
Overall Length 26 cm (10 ½")



EI-504-19
FiberGrip™ Vickers Bone Mallet
With Interchangeable Nylon Discs
Ø 25.0 mm, 300 Grams
Overall Length 19 cm (7 ½")



EI-506-19
FiberGrip™ Herbert Bone Mallet
Overall Length 19 cm (7 ½")

Bone Currettes
Scharfe Löffel
Cucharillas cortantes
Currettes tranchantes
Curette taglianti



FiberGrip™ Volkmann Bone Curette
Oval

EI-520-40
Fig. 0000
18.5 cm (7 ¼")

EI-520-30
Fig. 000
18.5 cm (7 ¼")

EI-520-20
Fig. 00
18.5 cm (7 ¼")

EI-520-10
Fig. 0
18.5 cm (7 ¼")

EI-520-01
Fig. 1
18.5 cm (7 ¼")

EI-520-02
Fig. 2
18.5 cm (7 ¼")

EI-520-03
Fig. 3
19 cm (7 ½")

EI-520-04
Fig. 4
19 cm (7 ½")

EI-520-05
Fig. 5
19 cm (7 ½")

EI-520-06
Fig. 6
19 cm (7 ½")



FiberGrip™ Volkmann Bone Curette
Oval
Overall Length 27.5 cm (10 ¾")

EI-522-01
Fig. 1

EI-522-02
Fig. 2

EI-522-03
Fig. 3

EI-522-04
Fig. 4

EI-522-05
Fig. 5

EI-522-06
Fig. 6

EI-522-10
Fig. 0

EI-522-20
Fig. 000

EI-522-30
Fig. 000

EI-522-40
Fig. 0000

Bone Curettes
Scharfe Löffel
Cucharillas cortantes
Curettes tranchantes
Curette taglienti



Volkmann Bone Curette
Oval
Overall Length 17 cm (6 3/4")

				
EI-524-30 Fig. 000 2.5 mm	EI-524-20 Fig. 00 3.4 mm	EI-5EI-40 Fig. 0000 2.8 mm	EI-5EI-30 Fig. 000 3.6 mm	EI-5EI-20 Fig. 00 4.4 mm
				
EI-524-10 Fig. 0 4.2 mm	EI-524-01 Fig. 1 5.2 mm	EI-5EI-10 Fig. 0 5.2 mm	EI-5EI-01 Fig. 1 6.8 mm	EI-5EI-02 Fig. 2 8.5 mm
				
EI-524-02 Fig. 2 6.3 mm	EI-524-03 Fig. 3 7.4 mm	EI-5EI-03 Fig. 3 10 mm	EI-5EI-04 Fig. 4 11.5 mm	EI-5EI-05 Fig. 5 13 mm
				
EI-524-04 Fig. 4 8 mm		EI-5EI-06 Fig. 6 14.5 mm		

Volkmann Bone Curette
Oval
Overall Length 17 cm (6 3/4")

Bone Currettes
Scharfe Löffel
Cucharillas cortantes
Currettes tranchantes
Curette taglianti



Bruns Bone Curette
Round
Overall Length 17 cm (6 3/4")

EI-528-30
Fig. 000
3.0 mm

EI-528-20
Fig. 00
4.0 mm

EI-528-10
Fig. 0
5.0 mm

EI-528-01
Fig. 1
6.0 mm

EI-528-02
Fig. 2
8.0 mm

EI-528-03
Fig. 3
10.0 mm

EI-528-04
Fig. 4
12.0 mm

EI-530-40
Fig. 0000
1.6 mm

EI-530-30
Fig. 000
2.3 mm

EI-530-20
Fig. 00
3.0 mm

EI-530-10
Fig. 0
3.5 mm

EI-530-01
Fig. 00
4.0 mm

EI-530-02
Fig. 0
5.5 mm

EI-530-03
Fig. 000
6.0 mm

EI-530-04
Fig. 00
6.8 mm

EI-530-05
Fig. 0
7.6 mm



Bruns Bone Curette
Round
Overall Length 17 cm (6 3/4")

Bone Curettes
Scharfe Löffel
Cucharillas cortantes
Curettes tranchantes
Curette taglienti



EI-532-30
Fig. 000
2.0 mm

EI-532-20
Fig. 00
2.5 mm

EI-532-10
Fig. 0
3.3 mm

EI-532-01
Fig. 1
3.8 mm

EI-532-02
Fig. 2
4.8 mm

EI-532-03
Fig. 3
5.3 mm

EI-532-04
Fig. 4
6.0 mm

EI-632-05
Fig. 5
6.7 mm

EI-532-06
Fig. 6
7.3 mm

Bruns Bone Curette
Oval, Solid Handle
Overall Length 23 cm (9")



EI-534-30
Fig. 000
3.6 mm

EI-534-20
Fig. 00
4.4 mm

EI-534-10
Fig. 0
5.2 mm

EI-534-01
Fig. 1
6.8 mm



Oval, Straight

EI-535-30
Fig. 000
3.6 mm

EI-535-20
Fig. 00
4.4 mm

EI-535-10
Fig. 0
5.2 mm

EI-535-01
Fig. 1
6.8 mm



Oval, Curved Downwards

EI-5EI-01
3.0 mm

EI-5EI-02
4.0 mm

EI-5EI-03
5.0 mm



Oval, Curved Upwards

Scoville Bone Curette
Oval
Overall Length 25 cm (9 3/4")

Bone Currettes
Scharfe Löffel
Cucharillas cortantes
Currettes tranchantes
Curette taglienti



Simon Bone Curette
Oval
Overall Length 25 cm (9 3/4")

EI-538-30
Fig. 000
3.6 mm

EI-538-20
Fig. 00
4.4 mm

EI-538-10
Fig. 0
5.2 mm

EI-538-01
Fig. 1
6.8 mm

EI-538-02
Fig. 2
8.5 mm

EI-538-03
Fig. 3
10 mm

EI-538-04
Fig. 4
11.5 mm

EI-638-05
Fig. 5
13 mm

EI-538-06
Fig. 6
14.5 mm



Caspar Bone Curette
Rectangular, Toothed
Overall Length 25 cm (9 3/4")

EI-540-01
4.0 mm

EI-540-02
5.0 mm



Caspar Bone Curette
Angled, Rectangular, Toothed
Overall Length 25 cm (9 3/4")

EI-541-01
3.0 mm

EI-541-02
4.0 mm

Bone Currettes
Scharfe Löffel
Cucharillas cortantes
Currettes tranchantes
Curette taglianti



- | | |
|----------------------------|-----------------------------|
| EI-542-01
5.0 mm | EI-542-06
11.0 mm |
| EI-542-02
5.5 mm | EI-542-07
12.5 mm |
| EI-542-03
6.4 mm | EI-542-08
14.5 mm |
| EI-542-04
8.0 mm | EI-542-09
16.8 mm |
| EI-542-05
9.0 mm | |

Hatfield Bone Curette
Oval
Overall Length 23 cm (9")

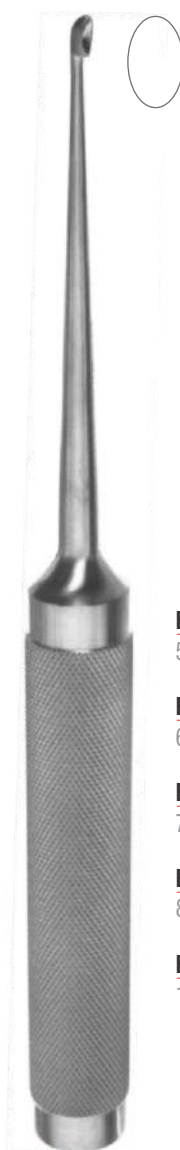

- | | |
|-----------------------------|-----------------------------|
| EI-544-01
5.0 mm | EI-544-06
11.4 mm |
| EI-544-02
6.3 mm | EI-544-07
12.7 mm |
| EI-544-03
7.6 mm | EI-544-08
14.0 mm |
| EI-544-04
8.9 mm | EI-544-09
15.2 mm |
| EI-544-05
10.2 mm | |

Cobb Bone Curette
Oval
Overall Length 28 cm (11")



- | |
|----------------------------|
| EI-546-01
Fig. 1 |
| EI-546-02
Fig. 2 |
| EI-546-03
Fig. 3 |
| EI-546-04
Fig. 4 |
| EI-546-05
Fig. 5 |
| EI-546-06
Fig. 6 |

Modell USA Bone Curette
Oval
Overall Length 16 cm (6 1/4")

Bone Curettes
Scharfe Löffel
Cucharillas cortantes
Curettes tranchantes
Curette taglienti



Modell USA Bone Curette
Oval, Left
Overall Length 15.5 cm (6")

EI-547-01
Fig. 1

EI-547-02
Fig. 2

EI-547-03
Fig. 3

EI-547-04
Fig. 4

EI-547-05
Fig. 5

EI-547-06
Fig. 6



Modell USA Bone Curette
Oval, Right
Overall Length 15.5 cm (6")

EI-548-01
Fig. 1

EI-548-02
Fig. 2

EI-548-03
Fig. 3

EI-548-04
Fig. 4

EI-548-05
Fig. 5

EI-548-06
Fig. 6

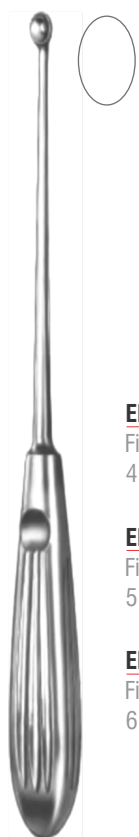

Halle Bone Curette
Oval
Overall Length 21 cm (8 1/4")

EI-5EI-1
Fig. 000
4.4 mm

EI-5EI-02
Fig. 00
5.2 mm

EI-5EI-03
Fig. 0
6.8 mm



Daubenspeck Bone Curette
Oval
Overall Length 20 cm (8")

EI-550-40
Fig. 0000
2.8 mm

EI-550-30
Fig. 000
6.8 mm

EI-550-20
Fig. 00
6.8 mm

EI-550-10
Fig. 0
5.2 mm

Bone Curettes
Scharfe Löffel
Cucharillas cortantes
Curettes tranchantes
Curette taglienti



EI-552-13
12.5 cm (5")



EI-552-14
14.5 cm (5 3/4")



EI-552-17
17 cm (6 3/4")



Volkmann Bone Curette
Double Ended, Oval/Oval



Ø 6.5 mm

EI-554-13
13 cm (5")



Ø 9.0 mm

EI-554-16
16 cm (6 1/4")



Ø 11.0 mm

EI-554-20
20 cm (8")



6.0 mm



7.0 mm



9.0 mm

Volkmann Bone Curette
Double Ended, Round/Oval

Bone Currettes
Scharfe Löffel
Cucharillas cortantes
Currettes tranchantes
Curette taglienti

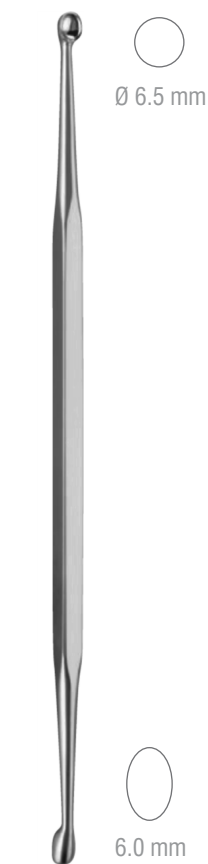

EI-556-21
Bone Curette
Double Ended, Round/Oval
Overall Length 21 cm (8 1/4")

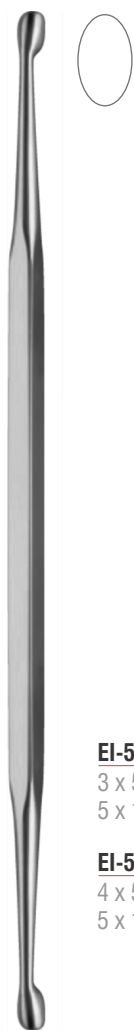

EI-557-01
3 x 5 mm /
5 x 10 mm

EI-557-02
4 x 5 mm /
5 x 12 mm

Volkmann Bone Curette
Double Ended, Oval/Oval
Overall Length 22 cm (8 1/2")



EI-558-00
Fig. 00 / Fig. 0

EI-558-01
Fig. 0 / Fig. 1

EI-558-12
Fig. 1 / Fig. 2

Williger Bone Curette
Double Ended, Oval/Oval
Overall Length 13.5 cm (5 1/4")



EI-559-00
Fig. 00 / Fig. 0

EI-559-10
Fig. 0 / Fig. 1

EI-559-11
Fig. 1 / Fig. 2

Williger Bone Curette
Double Ended, Oval/Oval
Overall Length 17 cm (6 3/4")

Bone Curettes
Scharfe Löffel
Cucharillas cortantes
Curettes tranchantes
Curette taglienti



EI-561-16
Bone Curette
Overall Length 16 cm (6 1/4")

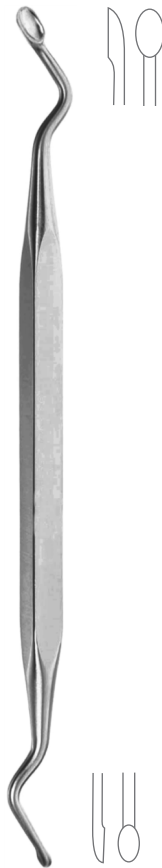

EI-563-16
Jansen Bone Curette
Overall Length 16 cm (6 1/4")

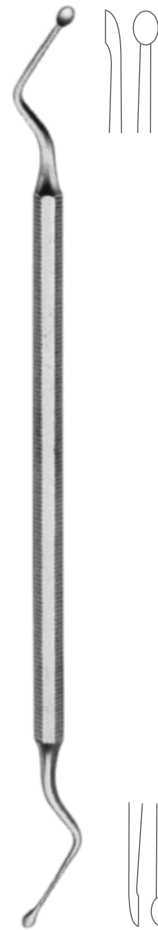

EI-565-16
Hemingway Bone Curette
Overall Length 17 cm (6 3/4")

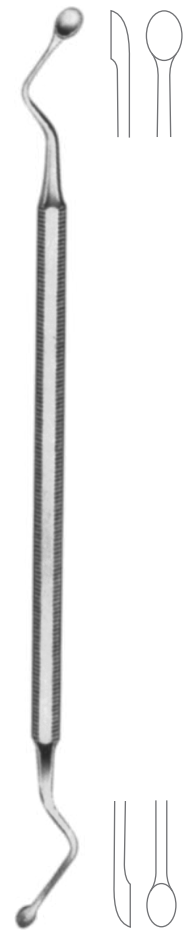

EI-5EI-16
Hemingway Bone Curette
Overall Length 17 cm (6 3/4")

Bone Curettes
Scharfe Löffel
Cucharillas cortantes
Curettes tranchantes
Curette taglienti



Hemingway Bone Curette
Overall Length 17 cm (6 3/4")

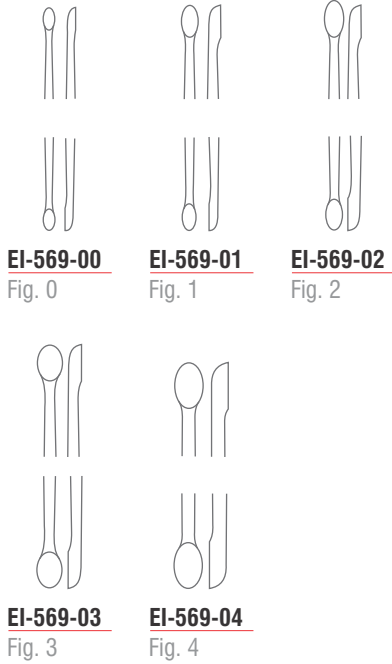

EI-569-00
Fig. 0

EI-569-01
Fig. 1

EI-569-02
Fig. 2

EI-569-03
Fig. 3

EI-569-04
Fig. 4

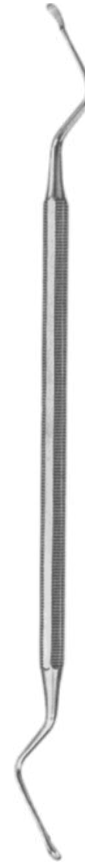

Lucas Bone Curette

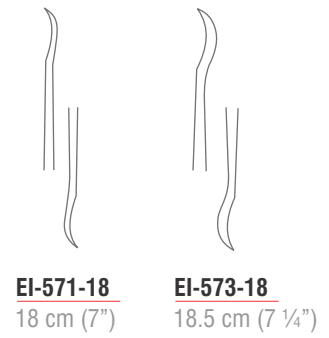

EI-571-18
18 cm (7")

EI-573-18
18.5 cm (7 1/4")



Kerpel Bone Curette
Overall Length 14.5 cm (5 3/4")

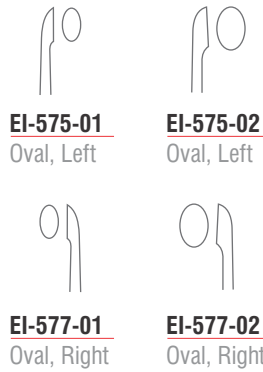

EI-575-01
Oval, Left

EI-575-02
Oval, Left

EI-577-01
Oval, Right

EI-577-02
Oval, Right

Bone Currettes, Periosteal Elevators
 Scharfe Löffel, Raspatorien
 Cucharillas cortantes, Periostótomos
 Curettes tranchantes, Rugines-raspatoires
 Curette taglianti, Periostotomi



- EI-580-01**
Fig. 1
- EI-580-02**
Fig. 2
- EI-580-03**
Fig. 3
- EI-580-04**
Fig. 4
- EI-580-05**
Fig. 5
- EI-580-06**
Fig. 6

Molt Bone Curette
 Overall Length 17 cm (6 3/4")



EI-582-24
Molt Bone Curette
 Round Handle
 Overall Length 19 cm (7 1/2")



- EI-591-32**
3.2 mm
- EI-591-46**
4.6 mm

Partsch Periosteal Raspatory/Elevator
 Overall Length 15 cm (6")

Periosteal Elevators
Raspatorien
Periostótomos
Rugines-raspatoires
Periostotomi



EI-593-15
Partsch Mod. Lange Periosteal Raspatory/Elevator
4.0 mm
Overall Length 14.5 cm (5 3/4")

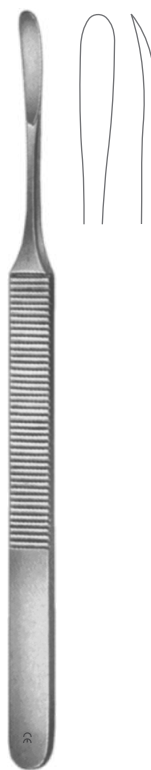

EI-595-15
Koenig Periosteal Raspatory/Elevator
Overall Length 15.5 cm (6")



EI-597-15
Trelat Periosteal Raspatory/Elevator
Overall Length 15.5 cm (6")

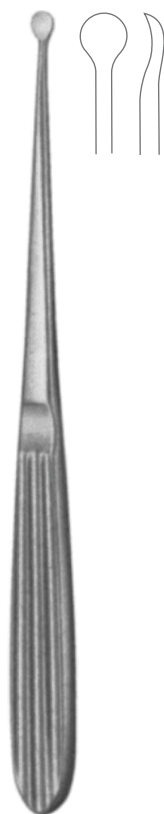

EI-599-17
Ward Periosteal Raspatory/Elevator
Overall Length 17 cm (6 3/4")



EI-601-20
Sewall Periosteal Raspatory/Elevator
Overall Length 20 cm (8")

Periosteal Elevators
Raspatorien
Periostótomos
Rugines-raspatoires
Periostotomi

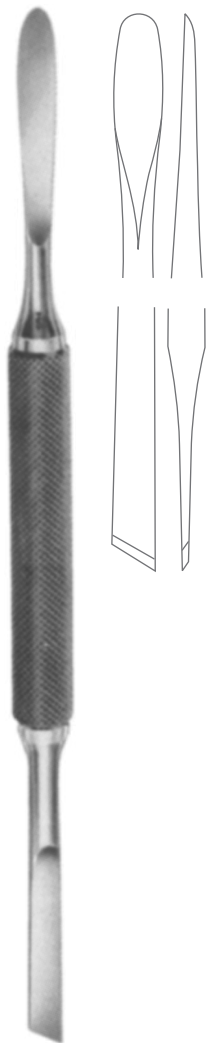

EI-602-16
Mead Periosteal Raspatory/Elevator
Overall Length 16.5 cm (6 ½")

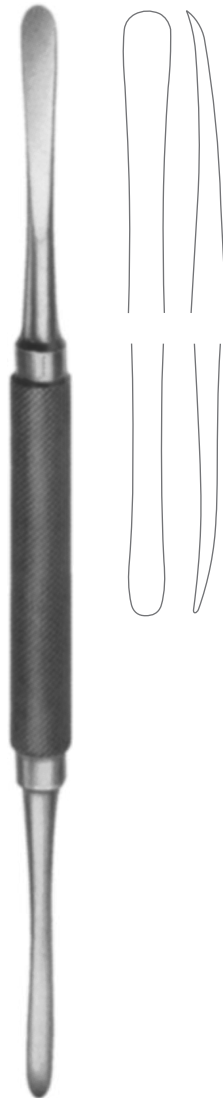

EI-603-18
Molt Periosteal Raspatory/Elevator
Overall Length 18 cm (7")



EI-605-18
Syme Periosteal Raspatory/Elevator
4.0 mm
Overall Length 18.5 cm (7 ¼")

Periosteal Elevators
Raspatorien
Periostótomos
Rugines-raspatoires
Periostotomi

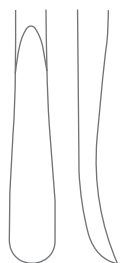
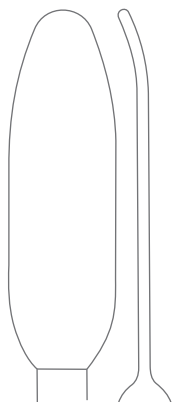

EI-607-18
Roberts Periosteal Raspatory/Elevator
Overall Length 18.5 cm (7 1/4")

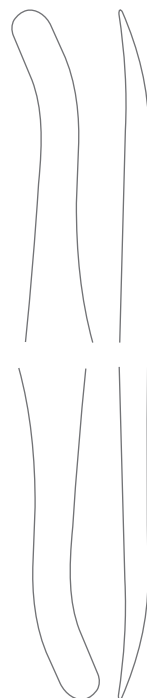

EI-609-19
Seldin Periosteal Raspatory/Elevator
Overall Length 19.5 cm (7 3/4")

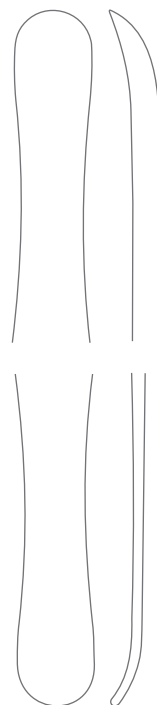

EI-611-19
Seldin Periosteal Raspatory/Elevator
Overall Length 19.5 cm (7 3/4")

Periosteal Elevators
Raspatorien
Periostótomos
Rugines-raspatoires
Periostotomi

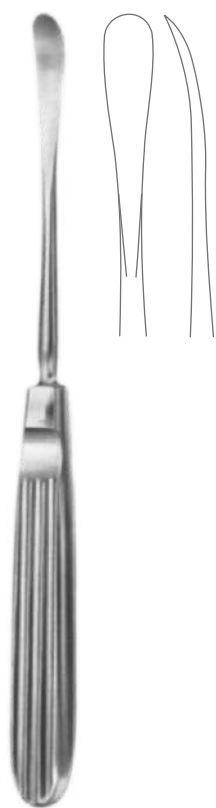

EI-613-19
Cottle Periosteal Raspatory/Elevator
8.0 mm
Overall Length 19.5 cm (7 3/4")

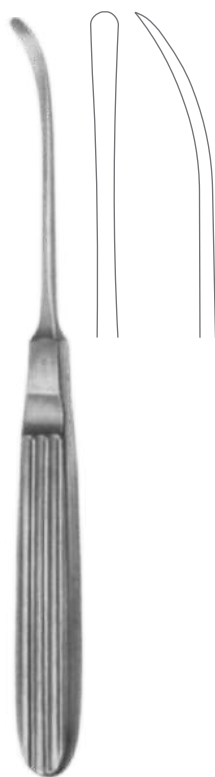

EI-615-17
Landolt Periosteal Raspatory/Elevator
Overall Length 18 cm (7")

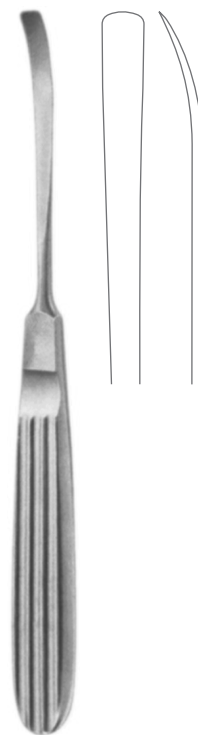

EI-617-18
Caspar Periosteal Raspatory/Elevator
Overall Length 18 cm (7")

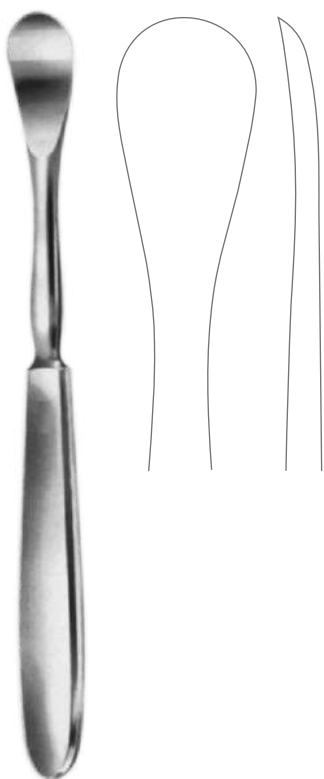

EI-619-18
Sedillot Periosteal Raspatory / Elevator
18 mm
Overall Length 18.5 cm (7 1/4")



EI-620-19
Cottle Periosteal Raspatory/Elevator
11.0 mm
Overall Length 19.5 cm (7 3/4")

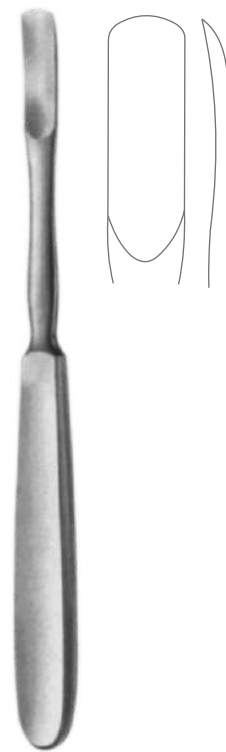

EI-621-18
Kraemer Periosteal Raspatory/Elevator
10.0 mm
Overall Length 18.5 cm (7 1/4")

Periosteal Elevators
Raspatorien
Periostótomos
Rugines-raspatoires
Periostotomi

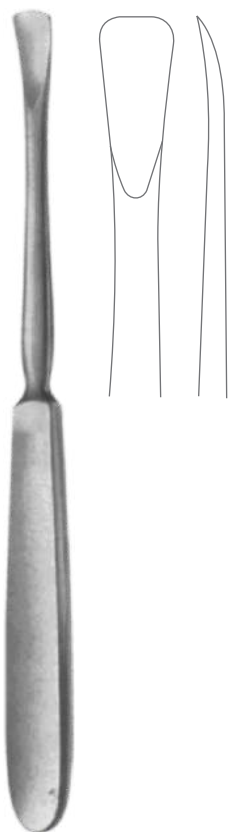

EI-623-19
Kraemer Periosteal Raspatory/Elevator
10.0 mm
Overall Length 19 cm (7 ½")

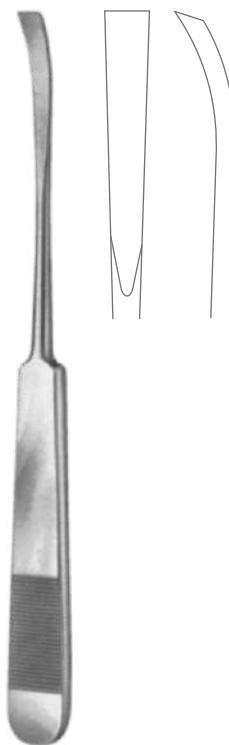

EI-625-16
Pennybaker Periosteal Raspatory/Elevator
Blunt, 6.0 mm
Overall Length 16.5 cm (6 ½")

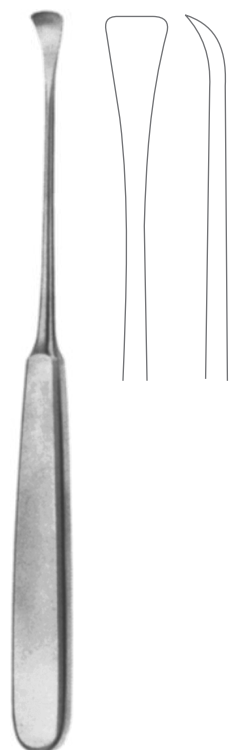

EI-627-19
Buchs Periosteal Raspatory/Elevator
9.5 mm
Overall Length 19 cm (7 ½")

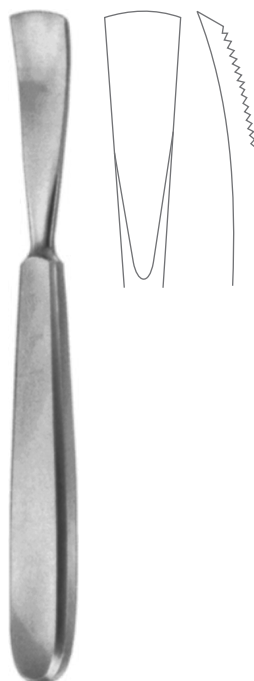

EI-629-16
Jansen Periosteal Raspatory/Elevator
15.0 mm
Overall Length 16.5 cm (6 ½")



Periosteal Elevators
Raspatorien
Periostótomos
Rugines-raspatoires
Periostotomi



EI-631-06

6.0 mm
18 cm (7")

EI-631-10

10.0 mm
19 cm (7 1/2")

EI-631-13

13.0 mm
19 cm (7 1/2")

EI-631-19

19.0 mm
20 cm (8")

EI-631-25

25.0 mm
21 cm (1/4")

Key Periosteal Raspatory/Elevator



EI-633-09

McGlamry Periosteal Raspatory/Elevator
9 mm
Overall Length 17 cm (6 3/4")

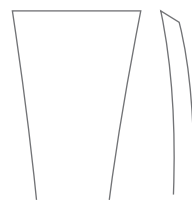

EI-635-01

16 mm
19 cm (7 1/2")

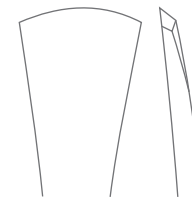

EI-635-02

16 mm
19 cm (7 1/2")

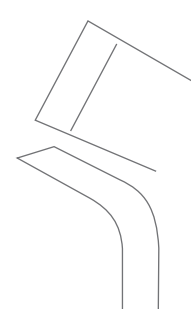

EI-635-03

12 mm
18.5 cm (7 1/4")

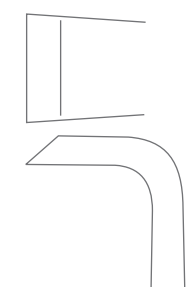

EI-635-04

12 mm
18 cm (7")

Langenbeck Periosteal Raspatory/Elevator

Periosteal Elevators
Raspatorien
Periostótomos
Rugines-raspatoires
Periostotomi

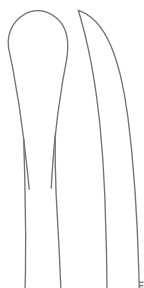

EI-6EI-01

7.0 mm
16 cm (6 1/4")

EI-6EI-02

15.0 mm
18.5 cm (7 1/4")

EI-6EI-03

20.0 mm
19 cm (7 1/2")

Hoen Periosteal Raspatory/Elevator

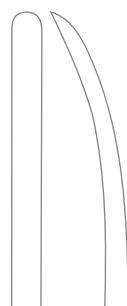

EI-639-01

4 mm
17 cm (7")



EI-639-02

5 mm
17.5 cm (7")



EI-639-03

6 mm
19.5 cm (7 3/4")



EI-639-04

7 mm
19.5 cm (7 3/4")

Cushing Periosteal Raspatory/Elevator

Periosteal Elevators
Raspatorien
Periostótomos
Rugines-raspatoires
Periostotomi

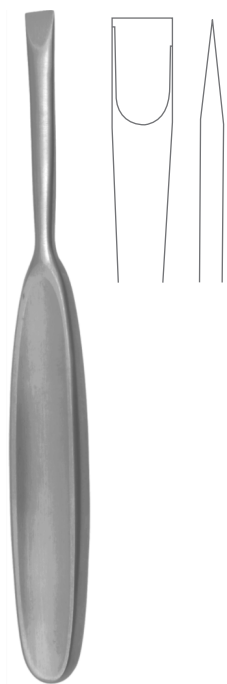

EI-640-17
Martin-Cushing Periosteal Raspatory/Elevator
8 mm
Overall Length 17 cm (6 3/4")

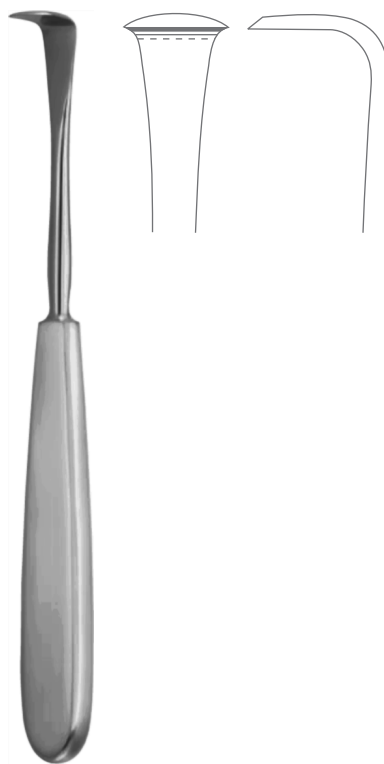

EI-641-18
Langenbeck Periosteal Raspatory/Elevator
14 mm
Overall Length 18 cm (7")

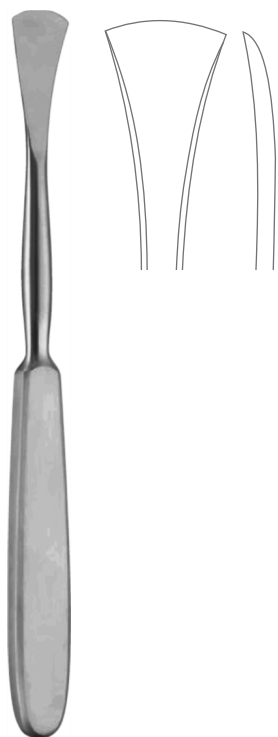

EI-643-19
Langenbeck Periosteal Raspatory/Elevator
16 mm
Overall Length 19.5 cm (7 3/4")

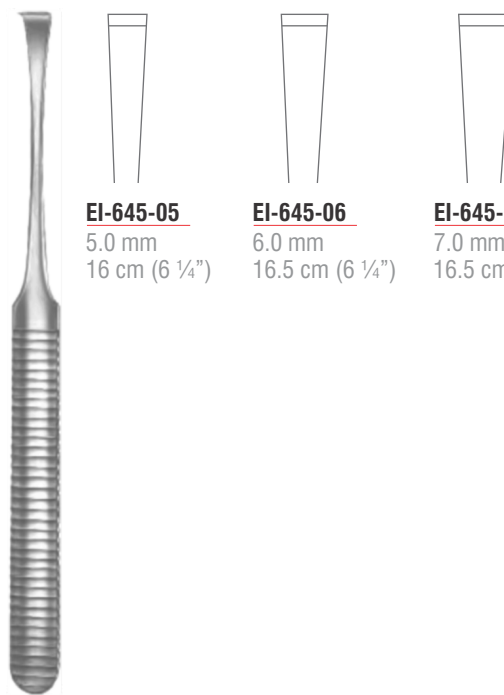

EI-645-05 5.0 mm 16 cm (6 1/4")	EI-645-06 6.0 mm 16.5 cm (6 1/4")	EI-645-07 7.0 mm 16.5 cm (6 1/4")
--	--	--

Langenbeck Periosteal Raspatory/Elevator

Periosteal Elevators
Raspatorien
Periostótomos
Rugines-raspatoires
Periostotomi

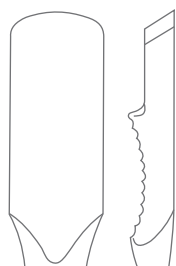

EI-648-15

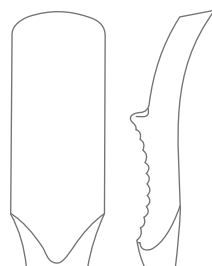

EI-6EI-15

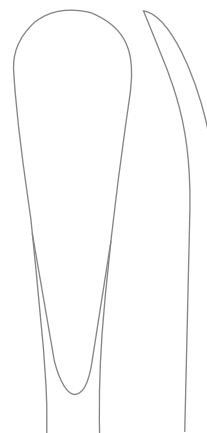

EI-651-21

Sedillot Periosteal Raspatory/Elevator

15 mm

Overall Length 22 cm (8 3/4")

Farabeuf Periosteal Raspatory / Elevator

12.5 mm

Overall Length 15 cm (6")

Periosteal Elevators
Raspatorien
Periostótomos
Rugines-raspatoires
Periostotomi



EI-654-19
FiberGrip™ Periosteal Raspatory/Elevator
6 mm
Overall Length 19 cm (7 1/2")



EI-655-20
FiberGrip™ Periosteal Raspatory/Elevator
14 mm
Overall Length 20 cm (8")



EI-657-20
FiberGrip™ Periosteal Raspatory/Elevator
14 mm
Overall Length 19 cm (7 1/2")



EI-659-18
FiberGrip™ Periosteal Raspatory/Elevator
6 mm
Overall Length 18 cm (7")



Periosteal Elevators
Raspatorien
Periostótomos
Rugines-raspatoires
Periostotomi



EI-661-18
FiberGrip™ Periosteal Raspatory/Elevator
6 mm
Overall Length 18 cm (7")



EI-663-18
FiberGrip™ Periosteal Raspatory/Elevator
3 mm
Overall Length 18 cm (7")

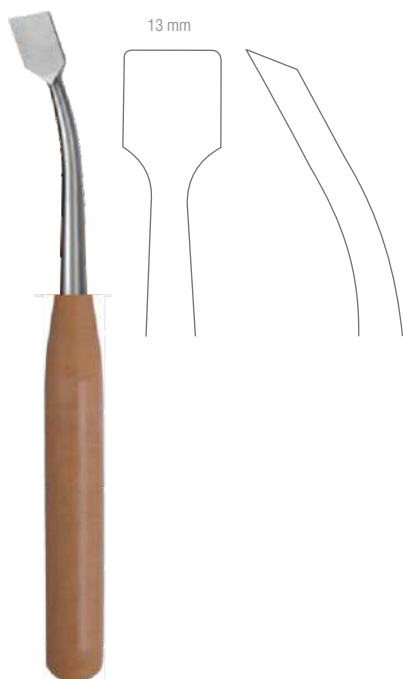

EI-665-17
FiberGrip™ Periosteal Raspatory/Elevator
13 mm
Overall Length 18.5 cm (7")

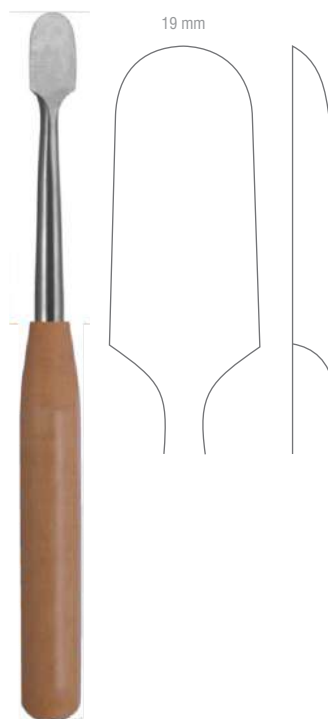

EI-666-20
FiberGrip™ Periosteal Raspatory/Elevator
19 mm
Overall Length 20 cm (8")



Periosteal Elevators
Raspatorien
Periostótomos
Rugines-raspatoires
Periostotomi



EI-661-18
FiberGrip™ Periosteal Raspatory/Elevator
6.0 mm
Overall Length 18 cm (7")



EI-663-18
FiberGrip™ Periosteal Raspatory/Elevator
3.0 mm
Overall Length 18 cm (7")



EI-665-17
FiberGrip™ Periosteal Raspatory/Elevator
13.0 mm
Overall Length 18.5 cm (7")



EI-666-20
FiberGrip™ Periosteal Raspatory/Elevator
19.0 mm
Overall Length 20 cm (8")

Periosteal Elevators
Raspatorien
Periostótomos
Rugines-raspatoires
Periostotomi

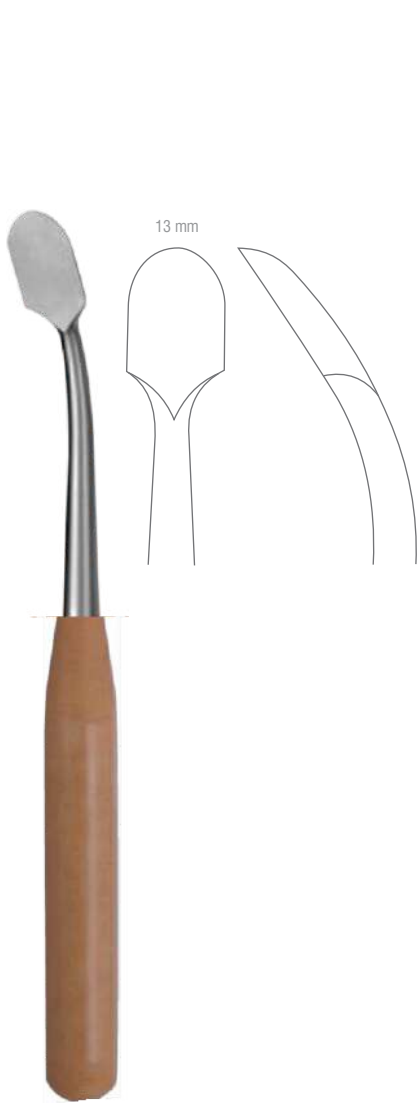
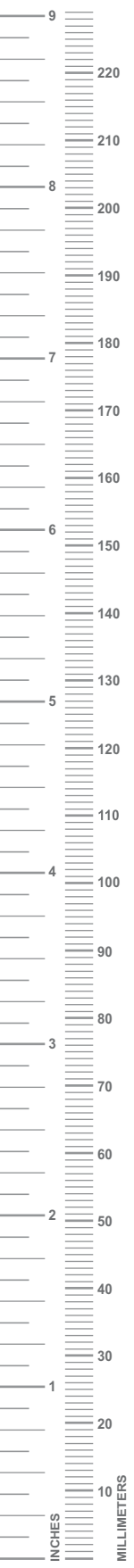

EI-6EI-18
FiberGrip™ Periosteal Raspatory/Elevator
13 mm
Overall Length 18 cm (7")



EI-669-27
FiberGrip™ Periosteal Raspatory/Elevator
20 mm
Overall Length 27 cm (10 3/4")



Periosteal Elevators
Raspatorien
Periostótomos
Rugines-raspatoires
Periostotomi



EI-671-08
8 mm

EI-671-17
17 mm

5 mm

FiberGrip™ Wagner Periosteal Raspatory/Elevator
Overall Length 33 cm (13")



EI-673-13
Williger Periosteal Raspatory/Elevator
5 mm
Overall Length 12.5 cm (5")

Periosteal Elevators
Raspatorien
Periostótomos
Rugines-raspatoires
Periostotomi



Kahre-Williger Periosteal Raspatory/Elevator
Overall Length 16 cm (6 1/4")



EI-675-01
4.0 mm



EI-675-02
5.0 mm

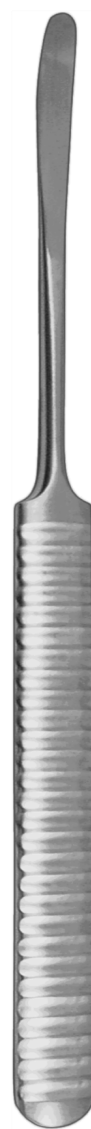

Williger Periosteal Raspatory/Elevator
Overall Length 16 cm (6 1/4")



EI-677-01
7 mm

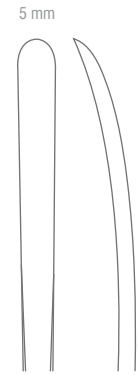

EI-677-02
5 mm

Periosteal Elevators
Raspatorien
Periostótomos
Rugines-raspatoires
Periostotomi

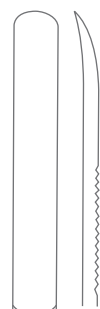

EI-679-06
6.0 mm

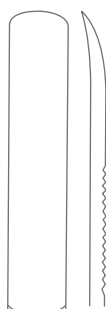

EI-679-08
8.0 mm

Periosteal Raspatory/Elevator
Overall Length 17 cm (6 3/4")



EI-680-01
For Adults
Curved Right



EI-680-02
For Adults
Curved Left



EI-681-01
For Children
Curved Right



EI-681-02
For Children
Curved Left

Doyen Rib Raspatory
Overall Length 17.5 cm (7")

Periosteal Elevators
Raspatorien
Periostótomos
Rugines-raspatoires
Periostotomi



EI-682-01
Overholt Rib Raspatory/Elevator
Fig. 1
Overall Length 29 cm (11 1/2")



EI-682-02
Overholt Rib Raspatory/Elevator
Fig. 2
Overall Length 27 cm (10 1/4")



EI-682-21
Alexander Periosteotome
Overall Length 21 cm (8 1/4")



EI-682-22
Matson Rib Elevator and Spreader
Overall Length 22.5 cm (8 3/4")

Periosteal Elevators
Raspatorien
Periostótomos
Rugines-raspatoires
Periostotomi

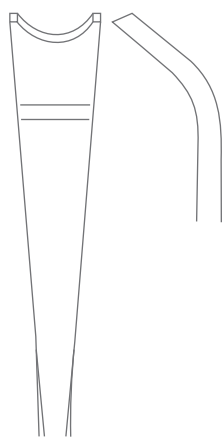

EI-683-01
Fig. 1
12 mm

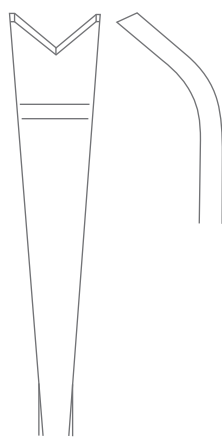

EI-683-02
Fig. 2
12 mm

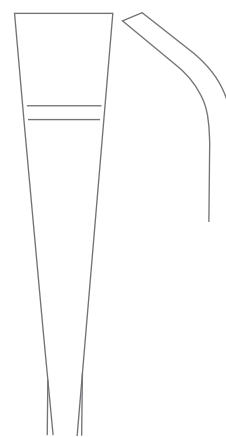

EI-683-03
Fig. 3
13 mm

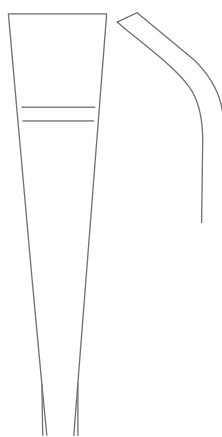

EI-683-04
Fig. 4
13 mm

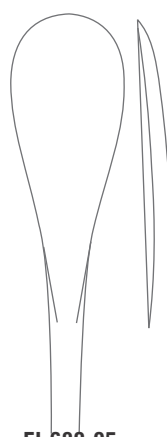

EI-683-05
Fig. 5
15 mm

Semb Periosteal Raspatory/Elevator
Overall Length 18.5 cm (7 1/4")

Periosteal Elevators
Raspatorien
Periostótomos
Rugines-raspatoires
Periostotomi



EI-684-10
10 mm

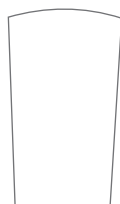

EI-684-15
15 mm

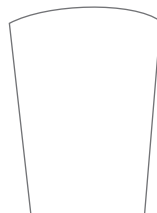

EI-684-20
20 mm

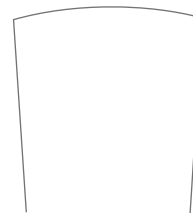

EI-684-25
25 mm

Lambotte Periosteal Raspatory/Elevator
Overall Length 21.5 cm (8 1/2")

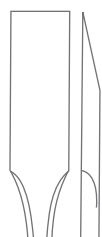

EI-685-01
7.9 mm



EI-685-02
5.0 mm



EI-685-03
7.7 mm



EI-685-04
6.3 mm

Adson Periosteal Raspatory/Elevator
Overall Length 17 cm (6 3/4")

Periosteal Elevators
Raspatorien
Periostótomos
Rugines-raspatoires
Periostotomi



EI-6EI-10
10.0 mm

EI-6EI-13
13.0 mm

EI-6EI-19
19.0 mm

EI-6EI-26
26.0 mm

EI-6EI-32
32.0 mm

Cobb Periosteal Raspatory/Elevator
Overall Length 28 cm (11")



EI-691-20
8.0 mm

EI-693-20
10.0 mm

Langenbeck Periosteal Elevator
Overall Length 19.5 cm (7 3/4")



EI-695-01
5.0 mm
17 cm (6 3/4")

EI-695-02
7.0 mm
17 cm (6 3/4")

EI-695-03
8.0 mm
17 cm (6 3/4")

EI-695-04
5.0 mm
19.5 cm (7 3/4")

Martin-Langenbeck Periosteal Elevator

Periosteal Elevators
Raspatorien
Periostótomos
Rugines-raspatoires
Periostotomi



Williger Periosteal Elevator

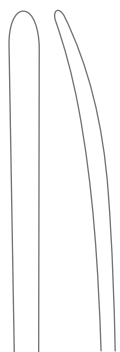

EI-697-04
4.0 mm
16 cm (6 ¼")

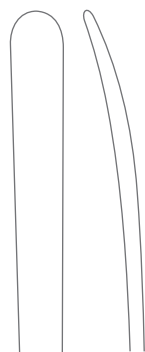

EI-697-07
4.0 mm
17 cm (6 ¾")



EI-699-16
Micro Elevator
Overall Length 16 cm (6 ¼")



EI-701-16
Phalangeal Elevator
Overall Length 16 cm (6 ¼")



Periosteal Elevators
Raspatorien
Periostótomos
Rugines-raspatoires
Periostotomi

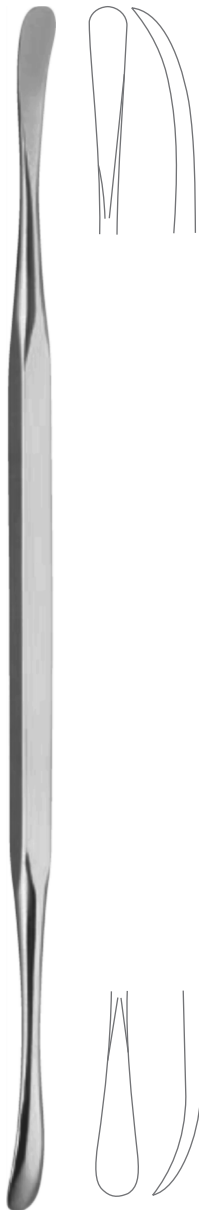

EI-703-21
Alderdyce Periosteal Elevator
Double Ended
Overall Length 21 cm (8 1/4")



EI-705-19
McDonald Periosteal Elevator
Double Ended
Overall Length 18.5 cm (7 1/4")



EI-707-13 13 cm (5 1/4")
EI-707-19 19 cm (7 1/2")

Watson-Cheyne Periosteal Elevator
Double Ended



EI-709-18
18 cm (7")

EI-709-20
20 cm (8")

Swedish Periosteal Elevator
Double Ended

Periosteal Elevators, Bone Levers
 Raspatorien, Knochenhebel
 Periostótomos, Elevadores para hueso
 Rugines-raspatoires, Leviers à os
 Periostotomi, Elevatori per ossa



EI-711-23
Pennybaker Periosteal Elevator
 Overall Length 23 cm (9")

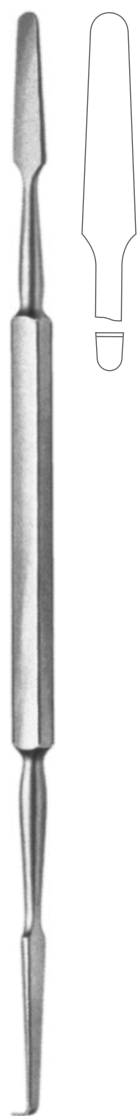

EI-713-22
O'Connell Periosteal Elevator
 Overall Length 22 cm (9")

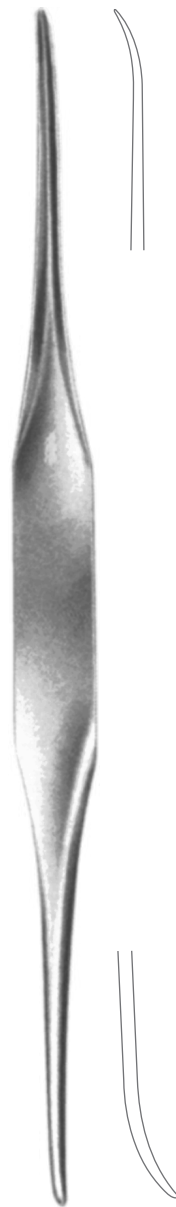

EI-715-24
Toennis Periosteal Elevator
 Overall Length 24 cm (9 1/2")



EI-721-06
Bone Lever
 Overall Length 16 cm (6 1/4")

Bone Levers
Knochenhebel
Elevadores para hueso
Leviers à os
Elevatori per ossa



EI-723-06
6.0 mm

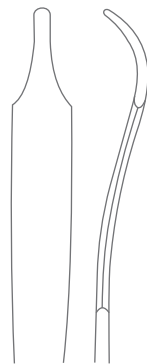

EI-723-08
8.0 mm



EI-725-15
Bone Lever
15.0 mm
Overall Length 16 cm (6 1/4")



EI-727-16
Bone Lever
15.0 mm
Overall Length 12 cm (4 3/4")

Bone Levers
Knochenhebel
Elevadores para hueso
Leviers à os
Elevatori per ossa

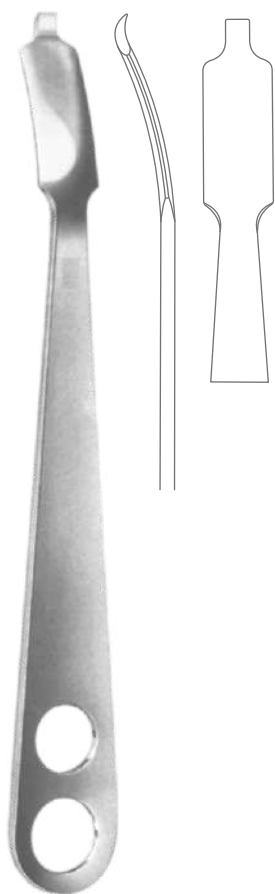

EI-729-22
Wagner Bone Lever
Overall Length 22 cm (8 3/4")

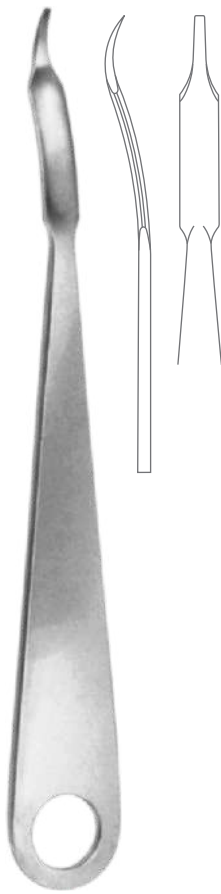

EI-731-22
Bone Lever
Overall Length 22 cm (8 3/4")



EI-733-08
Hohmann Bone Lever
Narrow Tip, 8.0 mm
Overall Length 22 cm (8 3/4")



EI-733-18
Hohmann Bone Lever
Narrow Tip, 18.0 mm
Overall Length 23.5 cm (9 1/2")

Bone Levers
Knochenhebel
Elevadores para hueso
Leviers à os
Elevatori per ossa



EI-733-43
Hohmann Bone Lever
Narrow Tip, 43.0 mm
Overall Length 23.5 cm (9 1/2")



EI-733-70
Hohmann Bone Lever
Narrow Tip, 70.0 mm
Overall Length 25 cm (9 3/4")



EI-735-43
Hohmann Bone Lever
Narrow Tip, 43.0 mm
Overall Length 23.5 cm (9 1/4")



EI-7EI-22
Hohmann Bone Lever
Wide Tip, 22.0 mm
Overall Length 25.5 cm (10")

Bone Levers
Knochenhebel
Elevadores para hueso
Leviers à os
Elevatori per ossa



EI-7EI-35
Hohmann Bone Lever
Wide Tip, 35.0 mm
Overall Length 29 cm (11 1/2")



EI-739-24
Hohmann Bone Lever
Wide Round Tip, 24.0 mm
Overall Length 27.5 cm (10 3/4")



EI-741-22
Lange-Hohmann Bone Lever
Wide Tip With Groove, 22.0 mm
Overall Length 25.5 cm (9 3/4")

Bone Levers
Knochenhebel
Elevadores para hueso
Leviers à os
Elevatori per ossa



Lange-Hohmann Modif Bone Lever

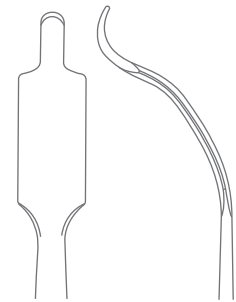

EI-743-30
30.0 mm
26.5 cm (10 1/2")

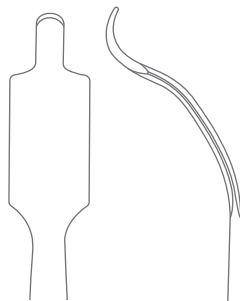

EI-057-15
33.0 mm
29 cm (11 1/2")



Verbrugge-Mueller Bone Lever

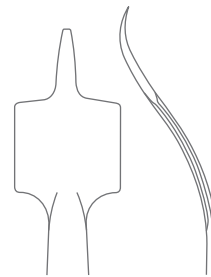

EI-745-44
44.0 mm
24 cm (9 1/2")

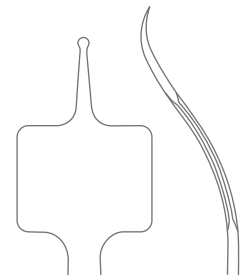

EI-745-65
65.0 mm
25.5 cm (10")

Bone Levers
Knochenhebel
Elevadores para hueso
Leviers à os
Elevatori per ossa



EI-7EI-40
Bone Lever
40.0 mm
Overall Length 29 cm (11 1/2")



EI-751-22
Bone Lever
22.0 mm
Overall Length 30 cm (12")



EI-753-24
Hohmann-Aldinger Bone Lever
24.0 mm
Overall Length 27 cm (10 3/4")

Bone Levers
Knochenhebel
Elevadores para hueso
Leviers à os
Elevatori per ossa



EI-755-37
Schumacher (Wagner) Bone Lever
Toothed Edge, 37 mm, 18 mm
Overall Length 34.5 cm (13 1/2")

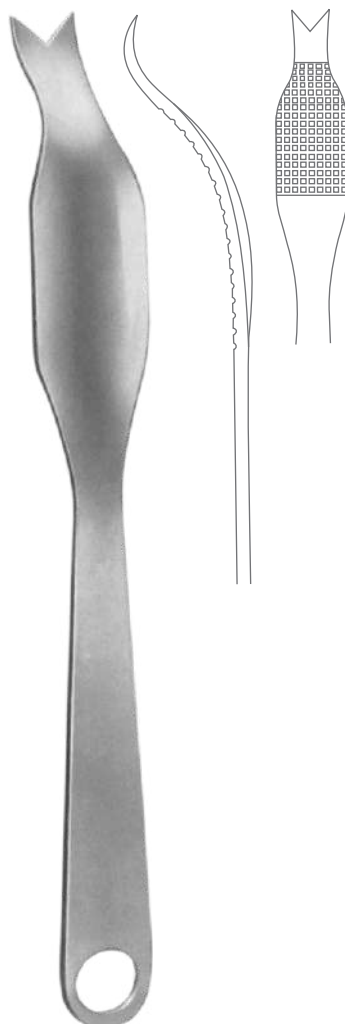

EI-757-35
Schumacher Bone Lever
Toothed Edge, 35 mm, 18 mm
Overall Length 29 cm (11 1/2")



EI-759-28
Watson-Jones Bone Lever
Overall Length 28 cm (11")



EI-761-43
43 mm
24 cm (9 1/2")

EI-761-60
60 mm
23.5 cm (9 1/4")

Bennett Bone Lever

Bone Levers
Knochenhebel
Elevadores para hueso
Leviers à os
Elevatori per ossa



EI-763-30
Murphy-Lane Bone Lever
30.0 mm
Overall Length 32 cm (12 ½")



EI-765-21
Lane-Terthowan Bone Lever
Overall Length 21.5 cm (8 ½")



EI-765-25
Lane Bone Lever
Overall Length 25.5 cm (10")



EI-765-23
Lane Bone Lever
Overall Length 23 cm (9")

Bone Levers, Knee Retractors
 Knochenhebel, Kniehaken
 Elevadores para hueso, Separadores para rodilla
 Leviers à os, Ecarteurs pour le genou
 Elevatori per ossa, Divaricatori per il ginocchio



Chandler Bone Lever



EI-7EI-14
 14.0 mm
 18 cm (7")



EI-7EI-19
 19.0 mm
 20 cm (8")

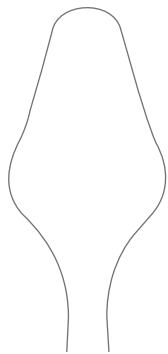

EI-7EI-25
 25.0 mm
 23 cm (9")

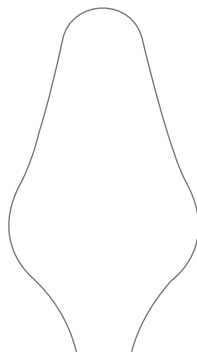

EI-7EI-30
 30.0 mm
 25 cm (9 3/4")



Smillie Knee Retractor
 Overall Length 14 cm (5 1/2")

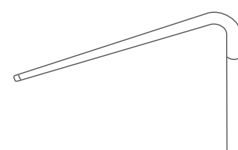

EI-769-01
 32 x 19 mm

EI-769-02
 48 x 19 mm

EI-769-03
 57 x 19 mm

EI-769-04
 52 x 13 mm

EI-769-05
 12 x 13 mm

Knee Retractors
Kniehaken
Separadores para rodilla
Ecarteurs pour le genou
Divaricatori per il ginocchio



EI-771-26
Blunt Knee Retractor
Blunt
Overall Length 26.5 cm (10 1/2")

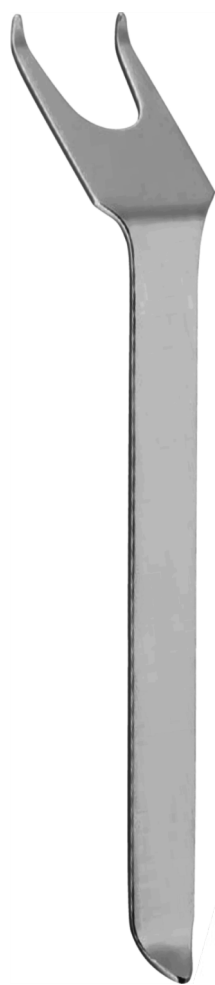

EI-773-26
Blunt Knee Retractor
Overall Length 26.5 cm (10 1/2")



EI-775-17
Blunt Knee Retractor
Overall Length 17.5 cm (7")

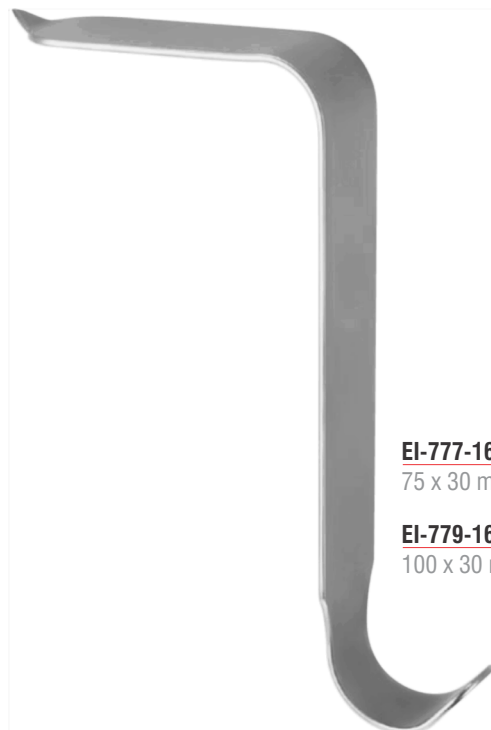

EI-777-16
75 x 30 mm

EI-779-16
100 x 30 mm

Taylor Knee Retractor
Overall Length 16 cm (6 1/4")

Knee Retractors, Meniscus Knives
Kniehaken, Meniskotome
Separadores para rodilla, Cuchillos para menisco
Ecarteurs pour le genou, Bistouris à ménisque
Divaricatori per il ginocchio, Meniscotomi

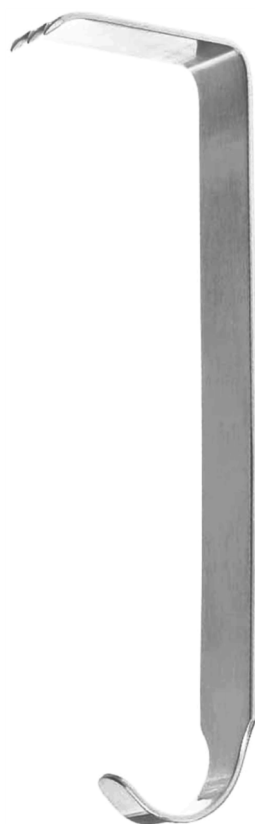

Hibbs Knee Retractor
Overall Length 23.5 cm (9 1/4")

EI-781-13
13 x 25 mm

EI-781-20
20 x 50 mm

EI-781-25
25 x 75 mm

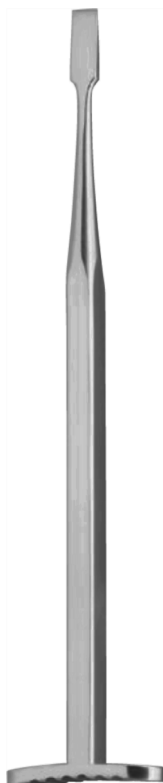

EI-790-17
Smillie Meniscus Knife
Straight
Overall Length 17.5 cm (7")



EI-791-17
Smillie Meniscus Knife
Left
Overall Length 17.5 cm (7")

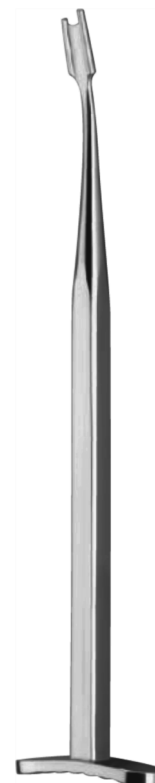

EI-793-17
Smillie Meniscus Knife
Right
Overall Length 17.5 cm (7")

Meniscus Knives
Meniskotome, Meniskusmesser
Cuchillos para menisco
Bistouris à ménisque
Meniscotomi



EI-795-18
Meniscus Knife
Overall Length 18 cm (7")



EI-797-22
Fig. 1

EI-799-22
Fig. 2

Neff Meniscus Knife
Overall Length 22 cm (8 3/4")



EI-801-22
Fig. 1

EI-803-22
Fig. 2

Selenius Meniscus Knife
Overall Length 21 cm (8 1/4")



EI-810-01
Fig. 1

EI-810-02
Fig. 2

EI-810-03
Fig. 3

EI-810-04
Fig. 4

EI-810-05
Fig. 5

Bunnell Tendon Stripper
Overall Length 15 cm (6")

Tendon Strippers
 Sehnenstripper
 Enucleadores de tendones
 Instruments à écorcher les tendons
 Scollatendini



EI-812-40

4.0 mm

EI-812-45

4.5 mm

EI-812-55

5.5 mm

Tendon Stripper
 Flexible Shaft
 Overall Length 23 cm (9")



EI-814-00
Tendon Passing Instruments
 Overall Length 33.5 cm (13 1/4")



EI-814-00
Screw Only For Tendon Passing Instruments
 Overall Length 33.5 cm (13 1/4")



EI-816-31
FiberGrip™ Fischer Tendon Stripper
 Overall Length 28.5 cm (11 1/4")



Tendon Tunnelling Forceps
Sehnendurchzugzangen
Pinzas para pasar tendones
Pinces pour passer les tendons
Pinze passa-tendini



EI-818-29
Tendon Stripper
Overall Length 23 cm (9")



EI-820-23
Bunnell Tendon Stripper
Malleable
Overall Length 16 cm (6 1/4")



EI-824-16
Steinmann Tendon Holding Forcep
Overall Length 15 cm (6")



EI-827-15
19 cm (7 1/2")

EI-827-19
24 cm (9 3/4")

EI-827-24
21 cm (8 1/4")

Brand Tendon Holding Forcep
1 x 2 Teeth

Tendon Tunnelling Forceps
 Sehnedurchzugzangen
 Pinzas para pasar tendones
 Pincas pour passer les tendons
 Pinze passa-tendini

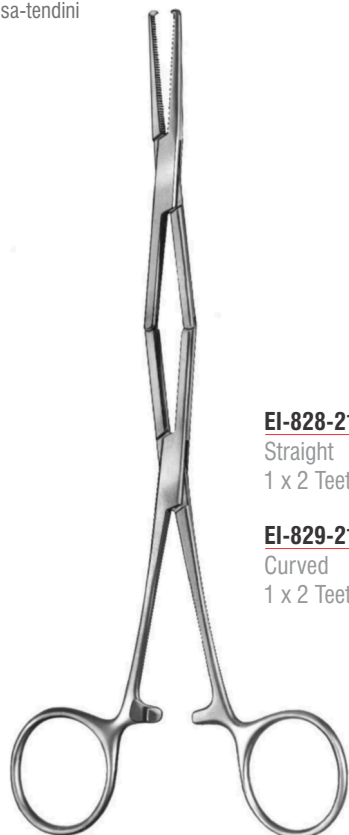

EI-828-21
 Straight
 1 x 2 Teeth

EI-829-21
 Curved
 1 x 2 Teeth

Tendon Tunnelling Forcep
 Overall Length 21 cm (8 ¼")



EI-831-11
Carroll Tendon Tunnelling Forcep
 Overall Length 11.5 cm (4 ½")



EI-832-13
Tendon Tunnelling Forcep
 Overall Length 11.5 cm (4 ½")



EI-834-20
KleineEI-Kutz Tendon Holding Forcep
 1 x 2 Teeth
 Overall Length 21 cm (8 ¼")



Tendon Interlacing Forcep
 Pointed

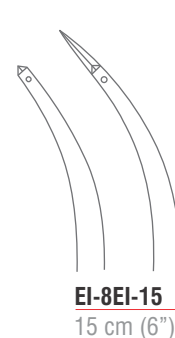
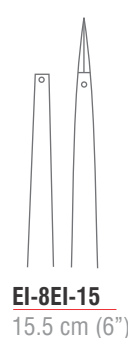

Reposition Forceps
Repositionszangen
Pinzas para reposición
Pinces à réduction
Pinze per riposizioni



EI-851-09
9 cm (3 1/2")

EI-851-14
15 cm (6")

Bone Positioning Forcep
Long Ratchet, Pointed



EI-853-13
Steinhauser Bone Positioning Forcep
Overall Length 13 cm (5")

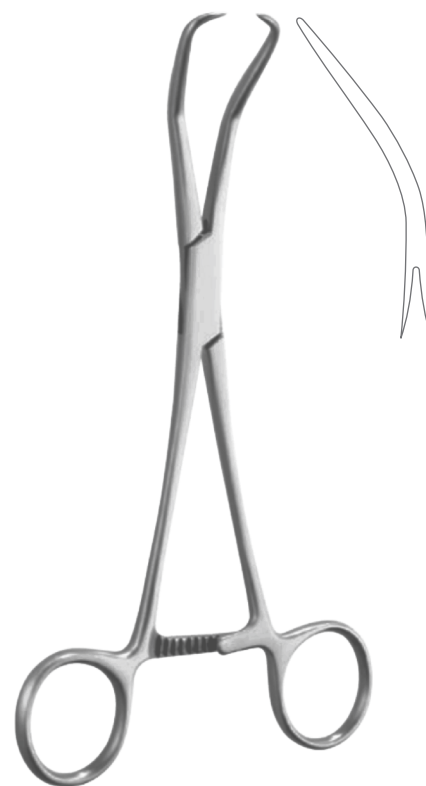

EI-855-17
Reill Bone Positioning Forcep
Overall Length 17 cm (6 3/4")



EI-857-20
Bone Positioning Forcep
Overall Length 20 cm (8")



EI-859-12
Bone Positioning Forcep
Long Ratchet, Pointed
Overall Length 13.5 cm (5 1/4")

Reposition Forceps, Bone Holding Forceps
Repositionszangen, Knochenhalte-zangen
Pinzas para reposición, Pinzas para hueso
Pinces à réduction, Daviers porte-os
Pinze per riposizioni, Tenaglie per ossa



EI-862-17
Lewin Bone Repositioning Forcep
Overall Length 18.5 cm (7 1/4")



EI-864-14
Bone Repositioning Forcep
Overall Length 14 cm (5 1/2")



EI-866-18
Bone Repositioning Forcep/Patella Forcep
Self Centering
Overall Length 18.5 cm (7 1/2")



EI-868-21
**Bone Repositioning Forcep/
Malleolar Forcep**
Overall Length 21 cm (8 1/4")



EI-869-14
Bone Holding Forcep
Overall Length 14 cm (5 1/2")

Reposition Forceps, Bone Holding Forceps
Repositionszangen, Knochenhalte­zangen
Pinzas para reposición, Pinzas para hueso
Pinces à réduction, Daviers porte-os
Pinze per riposizioni, Tenaglie per ossa

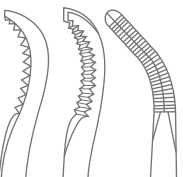

EI-871-16
17 cm (6 3/4")

EI-871-16
24 cm (9 1/2")

Bone Repositioning Forcep
With Tread Fixation

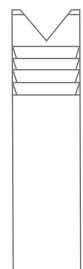

EI-8EI-21
Langenbeck Bone Holding Forcep
Overall Length 21 cm (8 1/4")



EI-876-21
Fergusson Bone Holding Forcep
Heavy Pattern
Overall Length 21 cm (8 1/4")

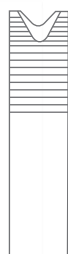

EI-8EI-20
Fergusson Bone Holding Forcep
Heavy Pattern
Overall Length 20 cm (8")



EI-880-20
Straight

EI-881-20
Curved

Bone Holding Forcep / Sequestrum Forcep
Overall Length 20 cm (8")

Reposition Forceps, Bone Holding Forceps
 Repositionszangen, Knochenhalte-zangen
 Pinzas para reposición, Pinzas para hueso
 Pincès à réduction, Daviers porte-os
 Pinze per riposizioni, Tenaglie per ossa

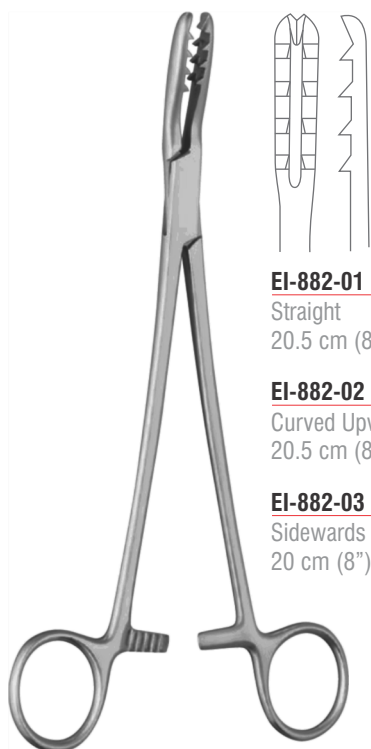

EI-882-01
 Straight
 20.5 cm (8")

EI-882-02
 Curved Upwards
 20.5 cm (8")

EI-882-03
 Sideways
 20 cm (8")

Bircher-Ganske Cartilage Seizing Forcep

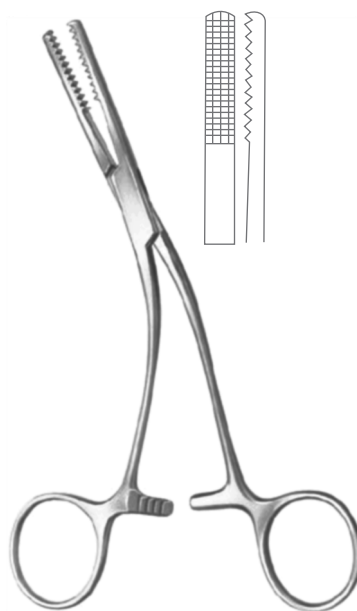

EI-885-16
Salyer Bone Holding Forcep
 Curved Sideways
 Overall Length 16 cm (6 1/4")



EI-8EI-01
Van Buren Bone Holding Forcep
 Overall Length 23 cm (9")



EI-8EI-02
Semb Bone Holding Forcep
 Overall Length 19 cm (7 1/2")

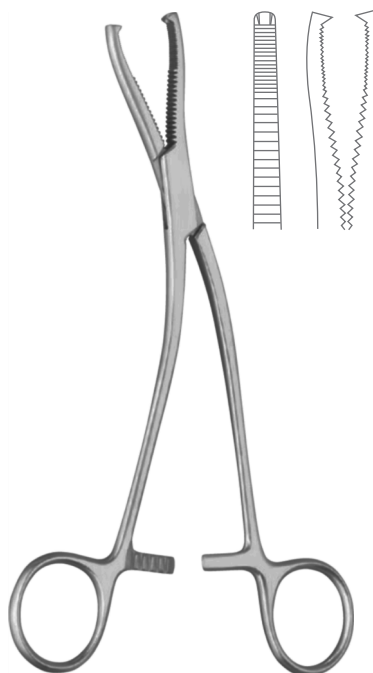

EI-889-19
Dingmann Cartilage Seizing Forcep
 Overall Length 18.5 cm (7 1/4")

Bone Holding Forceps
Knochenhalteanzgen
Pinzas para hueso
Daviers porte-os
Tenaglie per ossa

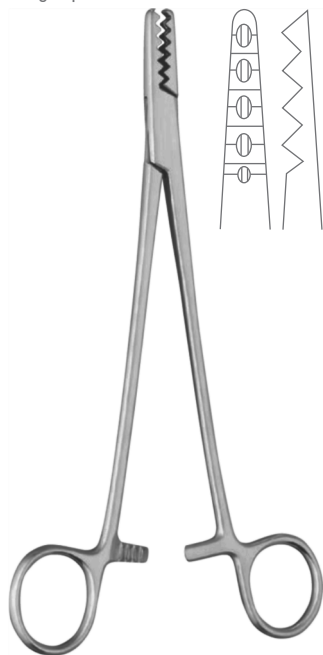

EI-892-19
Martin Cartilage Seizing Forcep
Overall Length 18.5 cm (7 1/4")



EI-894-19
Frosch Bone Holding Forcep
Overall Length 18 cm (7")



EI-896-17
17 cm (6 3/4")

EI-896-21
21 cm (8 1/4")

Kern Bone Holding Forcep



EI-899-21
21 cm (8 1/4")

EI-899-27
27 cm (10 3/4")

EI-899-30
30 cm (12")

Heygroves Bone Holding Forcep
With Thread Fixations



EI-901-19
Semb Bone Holding Forcep
Curved Sideways, With Ratchet
Overall Length 19 cm (7 1/2")

Bone Holding Forceps
Knochenhalte­zangen
Pinzas para hueso
Daviers porte-os
Tenaglie per ossa



Farabeuf Bone Holding Forcep

EI-904-23
23 cm (9")

EI-904-26
26 cm (10 1/4")



EI-906-26
Farabeuf Bone Holding Forcep
With Ratchet
Overall Length 26 cm (10 1/4")

EI-908-22
Lambotte Bone Holding Forcep
Straight
Overall Length 22 cm (8 3/4")

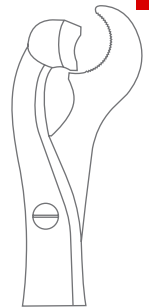

EVA



Lambotte Bone Holding Forcep
Straight, One Jaw Moveable

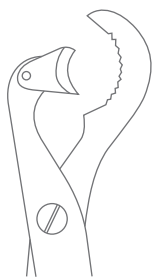

EI-908-26
26 cm (10 1/4")

EI-908-33
33 cm (13")



Ulrich Bone Holding Forcep
Straight, With Thread Fixation

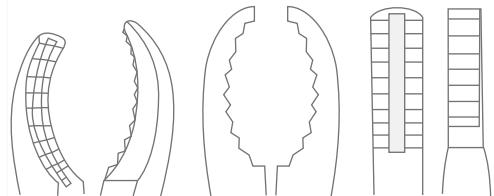

EI-910-23
23 cm (9")

EI-910-25
25 cm (9 3/4")

EI-910-28
28 cm (11")

Bone Holding Forceps
Knochenhalte­zangen
Pinzas para hueso
Daviers porte-os
Tenaglie per ossa



Ulrich Bone Holding Forcep
Straight, With Thread Fixation

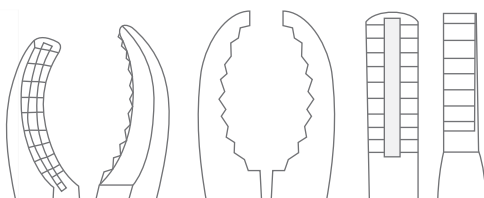

EI-911-23
22 cm (8 3/4")

EI-911-25
24 cm (9 1/2")

EI-910-28
27 cm (10 3/4")

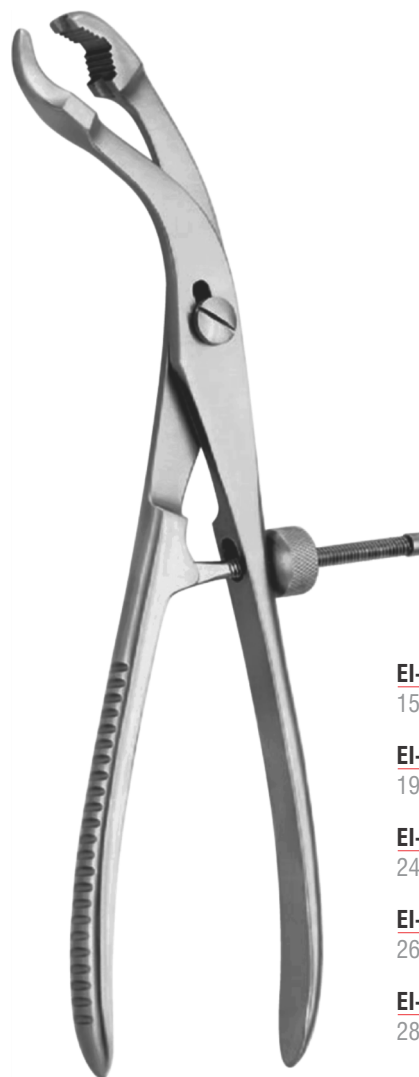

Bone Holding Forcep
Self Centering, With Thread Fixation

EI-913-15
15 cm (6")

EI-913-19
19 cm (7 1/2")

EI-913-24
24 cm (9 1/2")

EI-913-26
26 cm (10 1/4")

EI-913-28
28 cm (11")

Bone Holding Forceps
Knochenhaltezangen
Pinzas para hueso
Daviers porte-os
Tenaglie per ossa



EI-916-33
Lane Bone Holding Forcep
Without Ratchet
Overall Length 33 cm (13")



EI-918-33
Lane Bone Holding Forcep
With Ratchet
Overall Length 33 cm (13")



EI-921-01
25 cm (9 3/4")
EI-921-02
26 cm (10 1/4")
EI-921-03
27 cm (10 3/4")

Verbrugge Bone Holding Forcep



EI-923-01
Verbrugge Bone Holding Forcep
Overall Length 17.5 cm (7")



EI-925-00
Percy Amputation Shield
Detachable

Bone Rongeurs
Hohlmeißelzangen
Pinzas gubias
Pinces-gouges
Pinze-sgorbie



EI-931-01
17.5 cm (7")

EI-931-02
16.5 cm (6 1/2")

Stellbrink Bone Rongeur



EI-932-12
Friedman Bone Rongeur
Overall Length 12.5 cm (5")

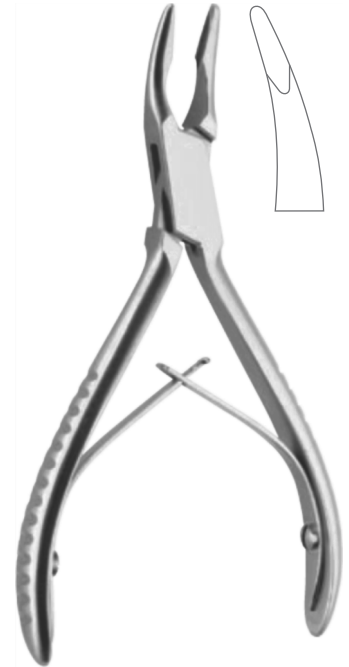

EI-933-01
Friedman Bone Rongeur
Overall Length 13.5 cm (5 1/4")

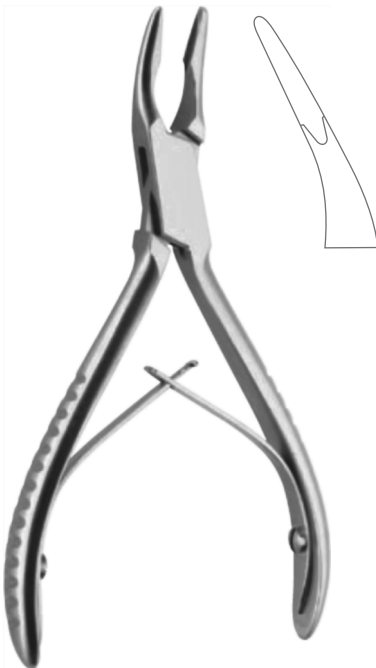

EI-934-02
Friedman Bone Rongeur
Overall Length 13.5 cm (5 1/4")



Cleveland Bone Rongeur



EI-935-01
13.5 cm (5 1/4")



EI-935-02
16.5 cm (6 1/2")

Bone Rongeurs
Hohlmeißelzangen
Pinzas gubias
Pinces-gouges
Pinze-sgorbie



EI-9EI-16
Mead Bone Rongeur
Overall Length 16.5 cm (6 1/2")



EI-9EI-18
Hartmann Bone Rongeur
Overall Length 17.5 cm (7")

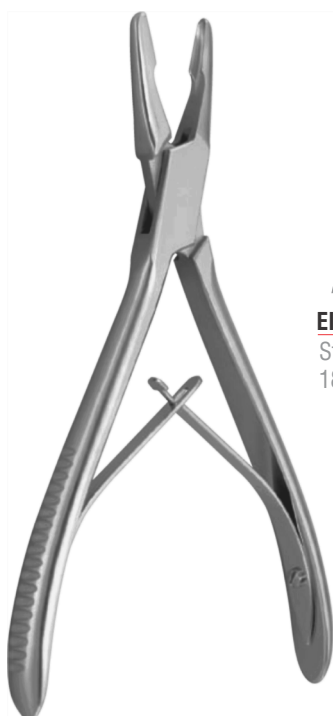

Jansen Bone Rongeur



EI-938-18
Straight
18 cm (7")



EI-939-18
Curved
18 cm (7")



EI-939-19
Angled
19 cm (7 1/2")

Bone Rongeurs
Hohlmeißelzangen
Pinzas gubias
Pinces-gouges
Pinze-sgorbie



EI-940-19
Lempert Bone Rongeur
Overall Length 19 cm (7 1/2")



Blumenthal Bone Rongeur

EI-941-01 15 cm (6")
EI-941-02 15 cm (6")
EI-941-03 14 cm (5 1/2")



Luer Bone Rongeur



EI-943-18
Curved
18 cm (7")



Luer Bone Rongeur
Overall Length 14.5 cm (5 3/4")

EI-945-01 **EI-945-02** **EI-945-03**

Bone Rongeurs
Hohlmeißelzangen
Pinzas gubias
Pinces-gouges
Pinze-sgorbie

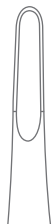
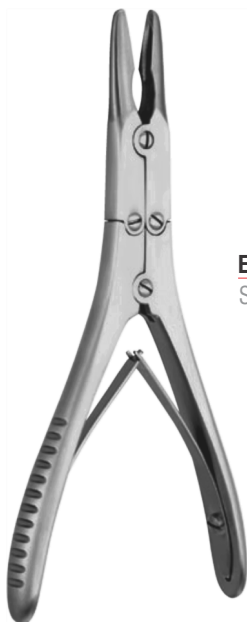

EI-946-15
Straight



EI-947-15
Curved

Bohler Bone Rongeur
Compound Action
Overall Length 15.5 cm (6")



EI-9EI-18
Beyer Bone Rongeur
Compound Action
Overall Length 18 cm (7")



EI-951-18
Zaufal-Jansen Bone Rongeur
Compound Action
Overall Length 18 cm (7")

Bone Rongeurs
Hohlmeißelzangen
Pinzas gubias
Pinces-gouges
Pinze-sgorbie



EI-953-17
Mayfield Bone Rongeur
Compound Action
Overall Length 18 cm (7")



EI-953-20
Marquard Bone Rongeur
Compound Action
Overall Length 20.5 cm (8")



EI-955-18
Ruskin Bone Rongeur
Compound Action
Overall Length 19 cm (7 1/2")



EI-955-24
Ruskin Bone Rongeur
Compound Action
Overall Length 24 cm (9 1/2")

Bone Rongeurs
Hohlmeißelzangen
Pinzas gubias
Pincès-gouges
Pinze-sgorbie

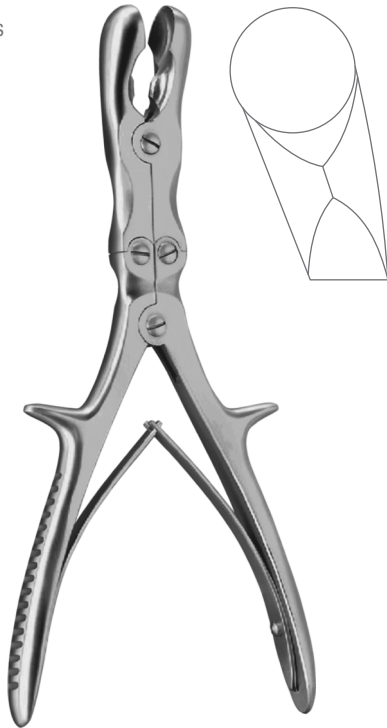

EI-957-22
Semb Bone Rongeur
Compound Action
Overall Length 23.5 cm (9 1/4")



EI-959-23
Stille-Ruskin Bone Rongeur
Compound Action
Overall Length 23.5 cm (9 1/4")



EI-959-24
Roettgen-Ruskin Bone Rongeur
Compound Action
Overall Length 24.5 cm (9 3/4")



EI-961-01



EI-961-02

EI-963-24
Frykholm Bone Rongeur
Compound Action
Overall Length 24.5 cm (9 3/4")



EI-964-22
Straight

EI-965-22
Curved

Leksell-Stille Bone Rongeur
Compound Action
Overall Length 24.5 cm (9 3/4")

Stille-Luer Bone Rongeur
Compound Action
Overall Length 22.5 cm (8 3/4")

Bone Rongeurs
Hohlmeißelzangen
Pinzas gubias
Pinces-gouges
Pinze-sgorbie

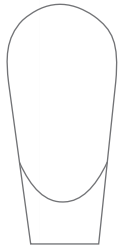

EI-966-23
Straight
23 cm (9")

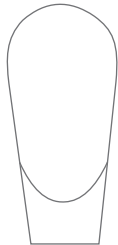

EI-966-27
Straight
26.5 cm (10 1/2")



EI-9EI-23
Curved
23 cm (9")



EI-9EI-27
Curved
26.5 cm (10 1/2")

Stille-Luer Bone Rongeur
Compound Action

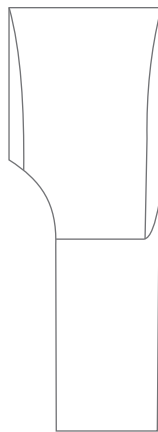

EI-968-01

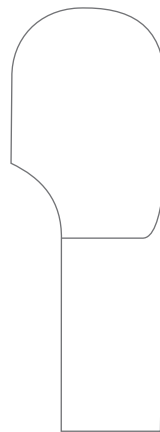

EI-968-02

Sauerbruch Bone Rongeur
Compound Action
Overall Length 31 cm (12 1/4")



Bone Cutting Forceps
Knochensplitterzangen
Pinzas cortantes para hueso
Pinces coupantes à os
Cesoie per ossa



EI-970-19
Cottle-Kazanjian Bone Cutting Forcep
Overall Length 18.5 cm (7 1/4")



Liston Bone Cutting Forcep



EI-972-14
Straight
14 cm (5 1/2")



EI-972-17
Straight
17 cm (6 3/4")



EI-972-19
Straight
20 cm (8")



EI-972-22
Straight
22 cm (8 3/4")



EI-973-14
Straight
14 cm (5 1/2")



EI-973-17
Straight
17 cm (6 3/4")

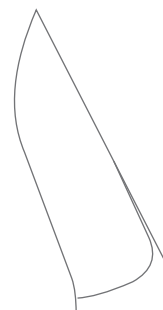

EI-973-19
Straight
20 cm (8")

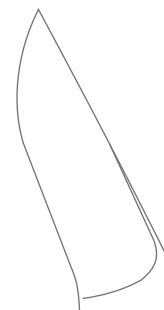

EI-973-22
Straight
22 cm (8 3/4")

Bone Cutting Forceps
Knochensplitterzangen
Pinzas cortantes para hueso
Pinces coupantes à os
Cesoie per ossa



Cleveland Bone Cutting Forcep



EI-975-15
14.5 cm (5 3/4")



EI-975-17
17 cm (6 3/4")



EI-976-15
Bohler Bone Cutting Forcep
Compound Action, Light
Overall Length 14.5 cm (5 3/4")



EI-977-15
Bohler Bone Cutting Forcep
Compound Action, Heavy
Overall Length 14.5 cm (5 3/4")



Bone Cutting Forceps
Knochensplitterzangen
Pinzas cortantes para hueso
Pinces coupantes à os
Cesoie per ossa



EI-979-15
Cleveland Bone Cutting Forcep
Overall Length 16 cm (6 1/4")



EI-980-18
Straight



EI-981-18
Curved

Ruskin-Liston Bone Cutting Forcep
Compound Action
Overall Length 18 cm (7")

Bone Cutting Forceps
Knochensplitterzangen
Pinzas cortantes para hueso
Pinces coupantes à os
Cesoie per ossa



Stille-Liston Bone Cutting Forcep
Compound Action



EI-982-01
Straight
27.5 cm (10 3/4")

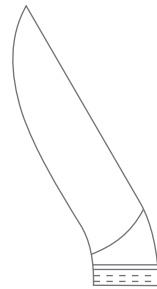

EI-982-02
Curved
23.5 cm (9 1/4")



EI-982-03
Curved
27.5 cm (10 3/4")

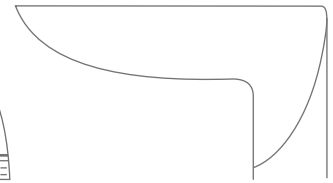

EI-982-04
26.5 cm (10 1/4")

Bone Cutting Forceps
Knochensplitterzangen
Pinzas cortantes para hueso
Pinces coupantes à os
Cesoie per ossa



EI-985-27
Liston-Key Bone Cutting Forcep
Compound Action
Overall Length 25.5 cm (10")



EI-9EI-25
Semb Bone Cutting Forcep
Compound Action
Overall Length 24.5 cm (9 3/4")

Hand Restrainer, Tourniquet
Handhalter, Kompressorium
Sujetador de mano, Compresor
Reteneur pour main, Compresseur
Fissatore per mano, compressorio



Hand Immobilizer
Aluminium

EI-988-01
For Children

EI-988-02
For Adults

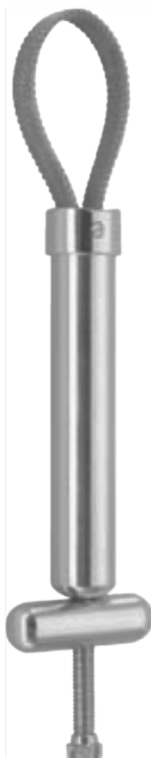

EI-990-10
Feldheim Tourniquet
Overall Length 10 cm (4")



EI-992-00
Ideal Finger Nail Drill Complete
With Drill Ref: EI-992-01 to EI-992-03



Spare Drill

EI-992-01
Small

EI-992-02
Medium

EI-992-03
Large



Finger Ring Saws, Finger Nail Drill
Fingerringsägen, Fingernagelbohrer
Sierras para abrir anillos, Dedo clavo perforación
Scies pour couper les bagues, Foret d'angle de doigt
Seghe per anelli, Dito trivello del chiodo



EI-994-17
Martin Finger Ring Saw
Overall Length 18.5 cm (7 1/4")

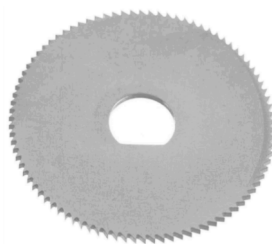

EI-994-00
Spare Saw Blade



EI-995-16
Martin Finger Ring Saw
Overall Length 18.5 cm (7 1/4")

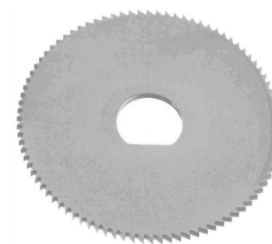

EI-995-01
Spare Saw Blade

Nail Extracting Forceps
Nageextraktionszangen
Pinzas para arrancar uñas
Pinces pour extraire les ongles
Pinze per la lacerazione delle unghie



EI-996-17
Finger Ring Saw
Overall Length 17 cm (6 3/4")

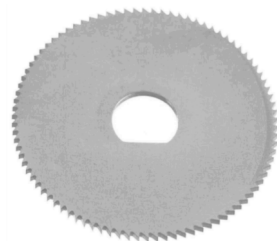

EI-996-10
Spare Saw Blade



EI-998-12
Anvil Nail Extracting Forcep
Overall Length 12.5 cm (5")



EI-999-13
Radolf Nail Extracting Forcep
Overall Length 14 cm (5 1/2")



Milium Knife, Lupus Instruments
 Milienmesser, Lupusinstrumente
 Chuchillo para milium, Instrumentos para lupus
 Couteau pour milium, Instruments pour les lupus
 Bisturi per milie, Strumenti per lupus



EI-100-14
Monocorps Milium Knife
 Overall Length 14 cm (5 ½")



EI-111-14
Vidal Lupus Scraper
 Overall Length 13 cm (5")



- EI-200-01**
Fig. 1
- EI-200-02**
Fig. 2
- EI-200-03**
Fig. 3
- EI-200-04**
Fig. 4

Fox Lupus Curette
 Overall Length 14 cm (5 ½")

Lupus Instruments
Lupusinstrumente
Instrumentos para lupus
Instruments pour les lupus
Strumenti per lupus



EI-220-01
Fig. 1



EI-220-02
Fig. 2



EI-220-03
Fig. 3



EI-220-04
Fig. 4



EI-220-05
Fig. 5



EI-220-06
Fig. 6

Wolf Lupus Curette
Overall Length 14 cm (5 1/2")



EI-225-04
4 Prongs

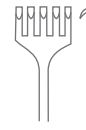

EI-225-05
5 Prongs

Kaye Face-Lift Hook
Overall Length 13 cm (5")

Dermal Punches
Hauttrephine
Trépanos para piel
Trépanos cutanés
Trefine cutanee



EI-300-00
Handle Only
8 cm (3 1/4")

EI-300-02
Ø 2.0 mm

EI-300-04
Ø 4.0 mm

EI-300-06
Ø 6.0 mm

EI-300-08
Ø 8.0 mm

EI-300-10
Ø 10.0 mm

EI-300-12
Ø 12.0 mm

Dermal Punch
Sharp
Overall Length 5.5 cm (2 1/4")



EI-320-02
Ø 12.0 mm

EI-320-03
Ø 12.0 mm

EI-320-04
Ø 12.0 mm

EI-320-05
Ø 12.0 mm

EI-320-06
Ø 12.0 mm

EI-320-07
Ø 12.0 mm

EI-320-08
Ø 12.0 mm

Keys Dermal Punch
Sharp
Overall Length 11 cm (4 1/2")

Comedone Extractors
Komedoneninstrumente
Extractores para comedones
Tire-comédons
Tiracomedoni



EI-351-14
Unna Comedone Extractor
Overall Length 14.5 cm (5 3/4")



EI-353-14
Unna Comedone Extractor
Overall Length 14.5 cm (5 3/4")



EI-361-10
Saalfeld Comedone Extractor
Overall Length 11 cm (4 1/2")

Comedone Extractors
Komedoneninstrumente
Extractores para comedones
Tire-comédons
Tiracomedoni



EI-365-14
Saalfeld Comedone Extractor
Overall Length 14.5 cm (5 ¾")

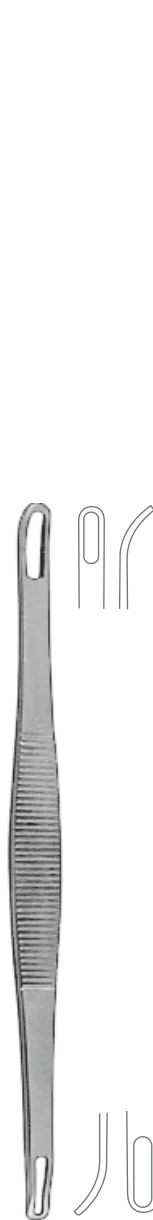

EI-371-10
Schamberg Comedone Extractor
Overall Length 9.5 cm (3 ¾")

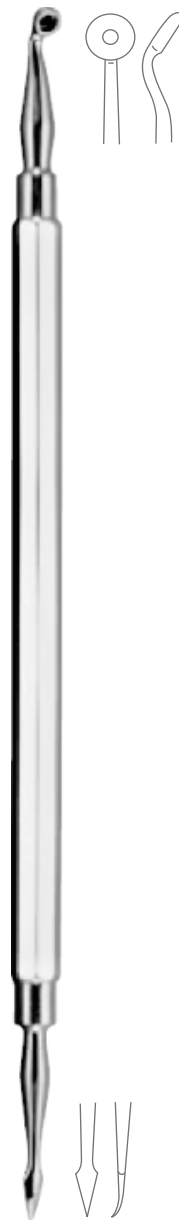

EI-381-14
Katsch Comedone Extractor
Overall Length 16 cm (6 ¼")

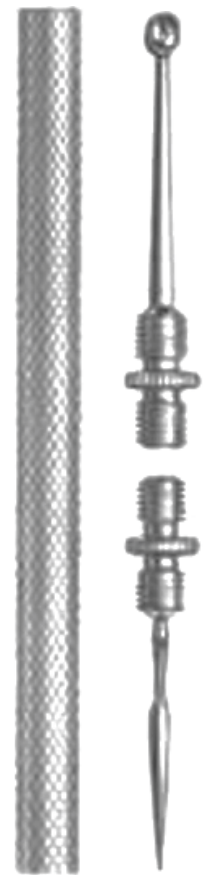

EI-390-11
Unna-Vidal Comedone Extractor
Overall Length 11.5 cm (4 ½")

Intestinal and Tissue Grasping Forceps
 Darm- und Gewebefasszangen
 Pinzas para intestinos y tejidos
 Pinces pour saisir intestins et tissus
 Pinze per afferrare intestino e tessuti



EI-010-12
Allis-Baby Tissue Grasping Forcep
 4 x 5 Teeth
 Overall Length 13 cm (5")



4:5



EI-012-15
Allis Tissue Grasping Forcep
 4 x 5 Teeth
 Overall Length 15.5 cm (6")



4:5

Intestinal and Tissue Grasping Forceps
 Darm- und Gewebefasszangen
 Pinzas para intestinos y tejidos
 Pincés pour saisir intestins et tissus
 Pinze per afferrare intestino e tessuti

EVA



EI-015-15
15.5 cm (6")



EI-015-19
19 cm (7 1/2")



EI-015-25
25.5 cm (10")



5:6

Allis Tissue Grasping Forcep
5 x 6 Teeth

STOMACH, INTESTINES, RECTUM



EI-020-16
15.5 cm (6")



EI-020-20
20 cm (8")



EI-020-25
24.5 cm (9 3/4")

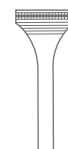

EI-020-30
30 cm (11 3/4")

Allis Atrauma Tissue Grasping Forcep

Intestinal and Tissue Grasping Forceps
 Darm- und Gewebefasszangen
 Pinzas para intestinos y tejidos
 Pinces pour saisir intestins et tissus
 Pinze per afferrare intestino e tessuti



EI-024-15
Allis-Adair Tissue Grasping Forcep
 10 x 11 Teeth
 Overall Length 16 cm (6 1/4")



10:11



EI-0EI-15
Boys-Allis Tissue Grasping Forcep
 5 x 6 Teeth
 Overall Length 15.5 cm (6")



5:6

Intestinal and Tissue Grasping Forceps
 Darm- und Gewebefasszangen
 Pinzas para intestinos y tejidos
 Pincers pour saisir intestins et tissus
 Pinze per afferrare intestino e tessuti

EVA

STOMACH, INTESTINES, RECTUM



EI-028-15
15.5 cm (6")

EI-028-19
19 cm (7 1/2")



EI-030-20
Thomas-Allis Tissue Grasping Forcep
 6 x 7 Teeth
 Overall Length 20.5 cm (8")



Intestinal and Tissue Grasping Forceps
 Darm- und Gewebefasszangen
 Pinzas para intestinos y tejidos
 Pincas pour saisir intestins et tissus
 Pinze per afferrare intestino e tessuti



EI-032-20
Allis Tissue Grasping Forcep
 5 x 6 Teeth
 Overall Length 20 cm (8")



5:6

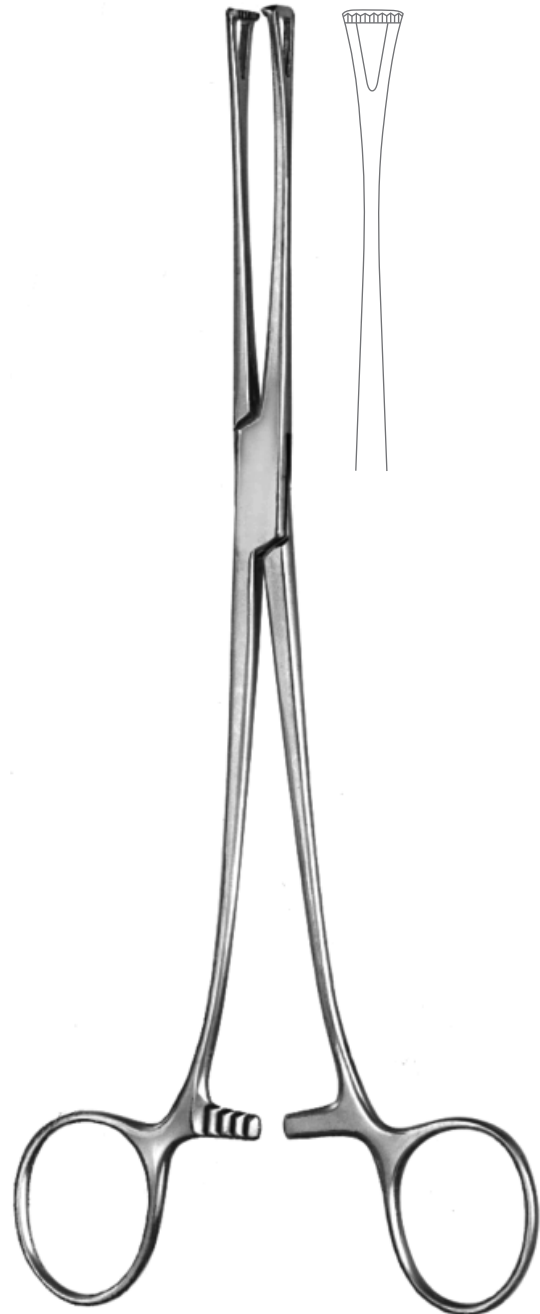

EI-040-20
Lockwood Tissue Grasping Forcep
 Overall Length 20 cm (8")

Intestinal and Tissue Grasping Forceps
Darm- und Gewebefasszangen
Pinzas para intestinos y tejidos
Pinces pour saisir intestins et tissus
Pinze per afferrare intestino e tessuti

EVA

STOMACH, INTESTINES, RECTUM



EI-042-18
Littlewood Tissue Grasping Forcep
Overall Length 18.5 cm (7 ¼")



EI-050-16
Williams Tissue Grasping Forcep
Overall Length 16.5 cm (6 ½")

Intestinal and Tissue Grasping Forceps
Darm- und Gewebefasszangen
Pinzas para intestinos y tejidos
Pinces pour saisir intestins et tissus
Pinze per afferrare intestino e tessuti

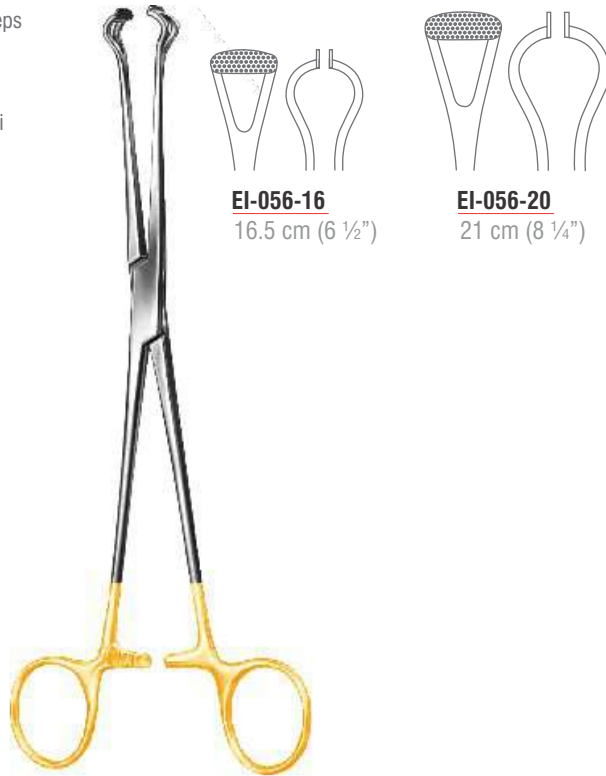

EI-056-16
16.5 cm (6 1/2")

EI-056-20
21 cm (8 1/4")

UltraGrip™ TC Babcock Tissue Grasping Forcep

ULTRA GRIP X



EI-060-16
15.5 cm (6")

EI-060-18
17.5 cm (7")

EI-060-20
21 cm (8 1/4")

EI-060-24
24 cm (9 1/2")

Babcock Tissue Grasping Forcep



Intestinal and Tissue Grasping Forceps
 Darm- und Gewebefasszangen
 Pinzas para intestinos y tejidos
 Pincés pour saisir intestins et tissus
 Pinze per afferrare intestino e tessuti

EVA

STOMACH, INTESTINES, RECTUM

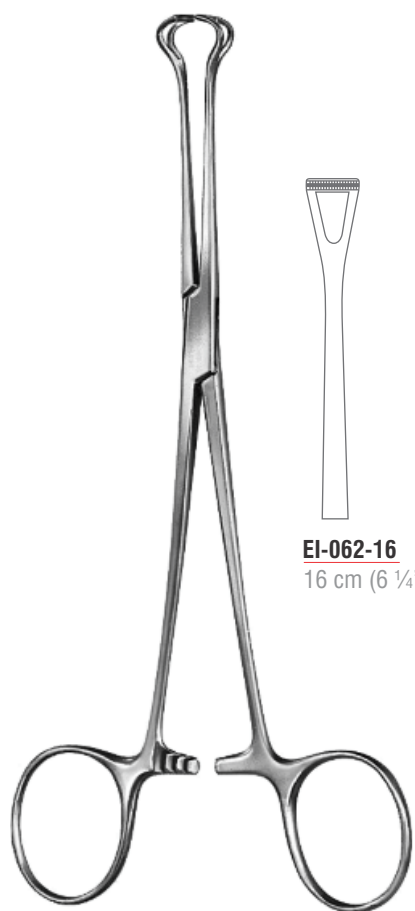

EI-062-16
16 cm (6 1/4")

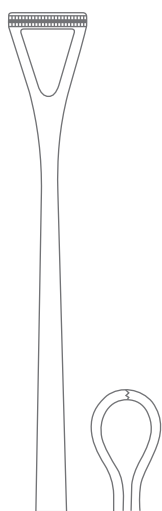

EI-062-20
20.5 cm (8")



EI-070-20
UltraGrip™ TC Duval Tissue Grasping Forcep
Overall Length 20.5 cm (8")

ULTRA GRIP

Atrauma™

Intestinal and Tissue Grasping Forceps
 Darm- und Gewebefasszangen
 Pinzas para intestinos y tejidos
 Pinces pour saisir intestins et tissus
 Pinze per afferrare intestino e tessuti



Duval Tissue Grasping Forcep

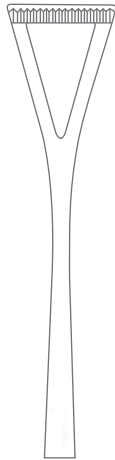

EI-072-18
Narrow Jaw
18 cm (7")

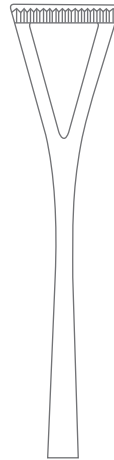

EI-072-20
Narrow Jaw
20.5 cm (8")

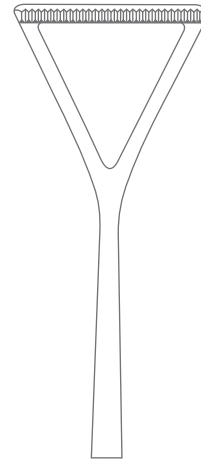

EI-0EI-20
Wide Jaw
20.5 cm (8")

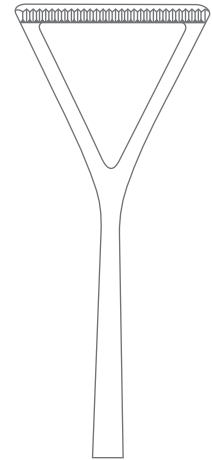

EI-0EI-23
Wide Jaw
23 cm (9")

Intestinal Clamps
Darmklemmen
Pinzas intestinales
Pincas intestinales
Pinze intestinali

EVA

STOMACH, INTESTINES, RECTUM



EI-080-22
Gregoire Rhomboid Grasping Forcep
Overall Length 22 cm (8 ½")



EI-100-18
Straight
18 cm (7")

EI-101-18
Curved
17.5 cm (7")

Doyen-Baby Intestinal Clamp

Intestinal Clamps
Darmklemmen
Pinzas intestinales
Pinces intestinales
Pinze intestinali



Doyen Intestinal Clamp

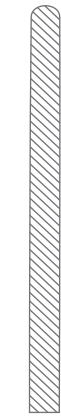

EI-102-23
Straight

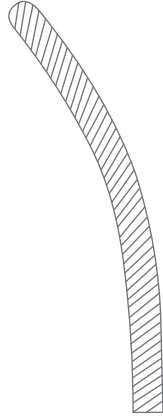

EI-103-23
Curved



Mayo-Robson Intestinal Clamp



EI-110-21
Straight
21.5 cm (8 1/2")

EI-110-23
Straight
23.5 cm (9 1/4")

EI-110-25
Straight
25.5 cm (10")



EI-111-21
Curved
21.5 cm (8 1/2")

EI-111-23
Curved
23 cm (9")

EI-111-25
Curved
24.5 cm (9 3/4")

Intestinal Clamps
Darmklemmen
Pinzas intestinales
Pinces intestinales
Pinze intestinali

EVA

STOMACH, INTESTINES, RECTUM

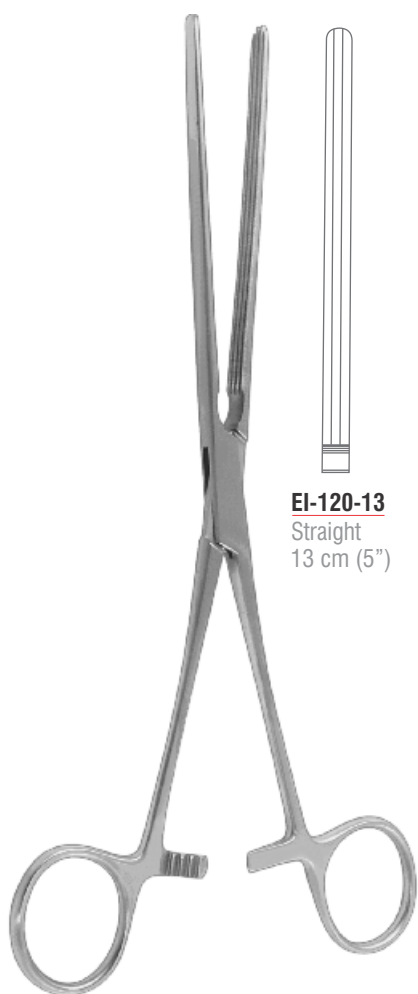

EI-120-13
Straight
13 cm (5")



EI-121-13
Curved
13 cm (5")



EI-122-13
Straight
22.5 cm (8 3/4")

EI-122-13
Straight
25 cm (9 3/4")

EI-122-13
Straight
28.5 cm (11 1/4")



EI-123-13
Curved
22.5 cm (8 3/4")

EI-123-13
Curved
24.5 cm (9 3/4")

EI-123-13
Curved
27.5 cm (10 3/4")

Kocher-Baby Intestinal Clamp

Kocher Intestinal Clamp

Intestinal Clamps
Darmklemmen
Pinzas intestinales
Pinces intestinales
Pinze intestinali



EI-128-16
Allen Intestinal Clamp
Overall Length 16 cm (6 1/4")

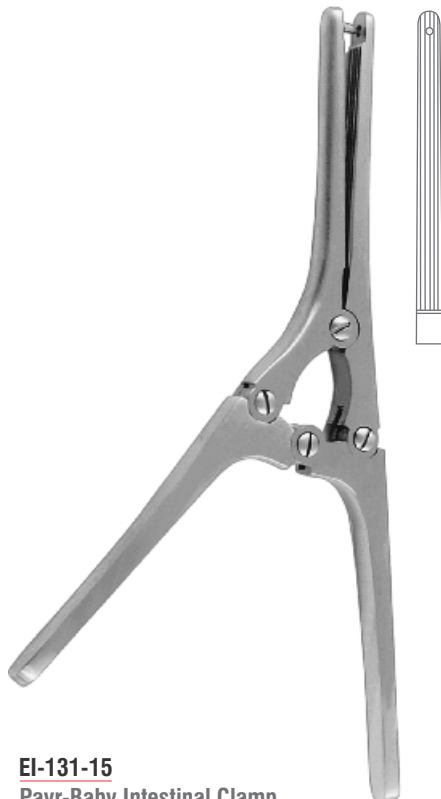

EI-131-15
Payr-Baby Intestinal Clamp
Overall Length 15 cm (6")



EI-133-21
20.5 cm (8")

EI-133-29
29 cm (11 1/2")

EI-133-35
34.5 cm (13 1/2")



Intestinal Clamps
Darmklemmen
Pinzas intestinales
Pinces intestinales
Pinze intestinali

EVA

STOMACH, INTESTINES, RECTUM



Nussbaum Intestinal Clamp
Overall Length 25 cm (9 3/4")

EI-138-25
Straight

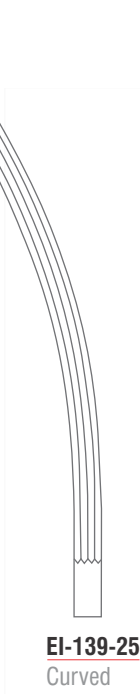

EI-139-25
Curved

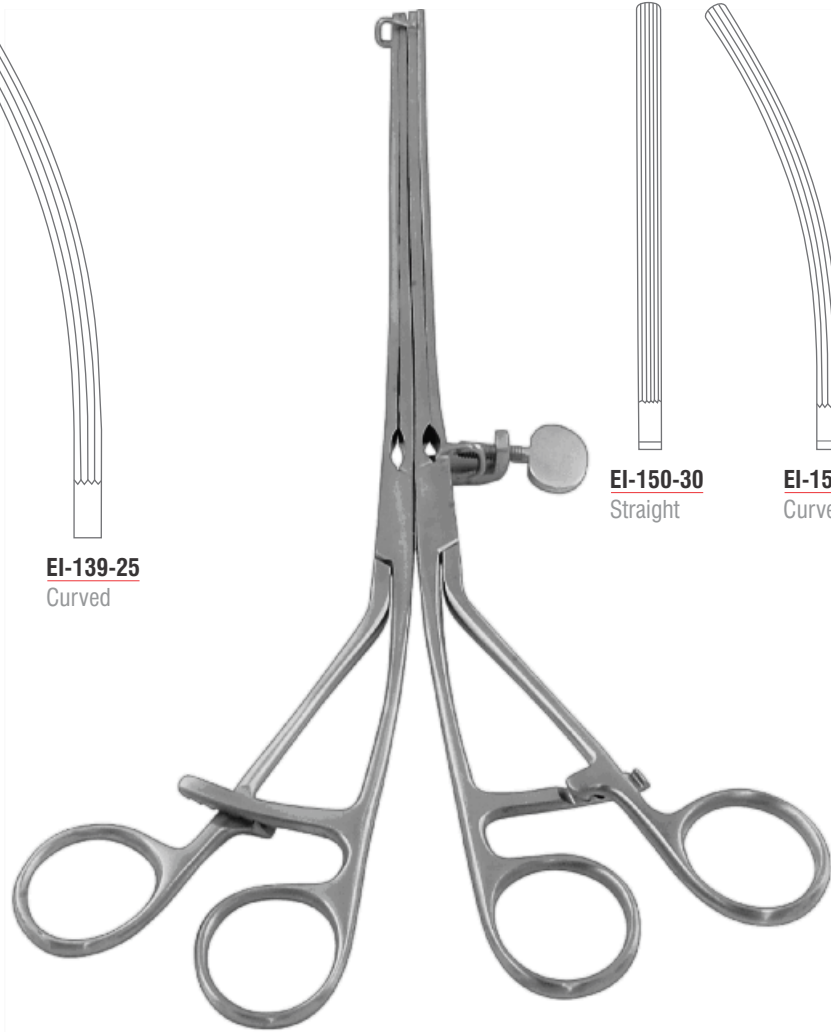

Lane Intestinal Clamp
Overall Length 30 cm (11 3/4")

EI-150-30
Straight



EI-151-30
Curved



Intestinal Clamps
Darmklemmen
Pinzas intestinales
Pinces intestinales
Pinze intestinali

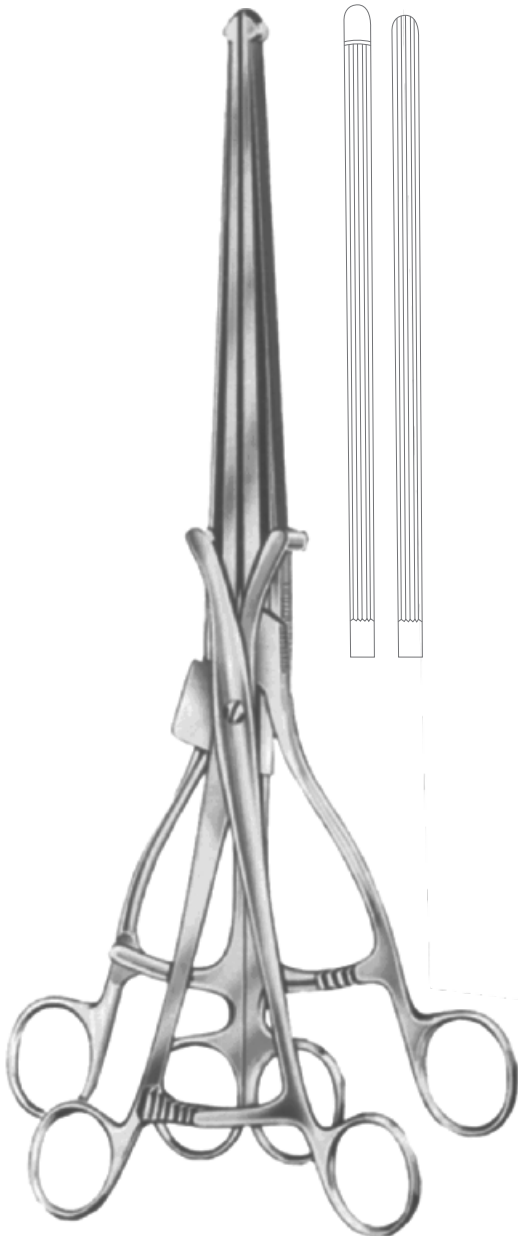

EI-156-36
Haberer Intestinal Clamp
Overall Length 36 cm (14 1/4")

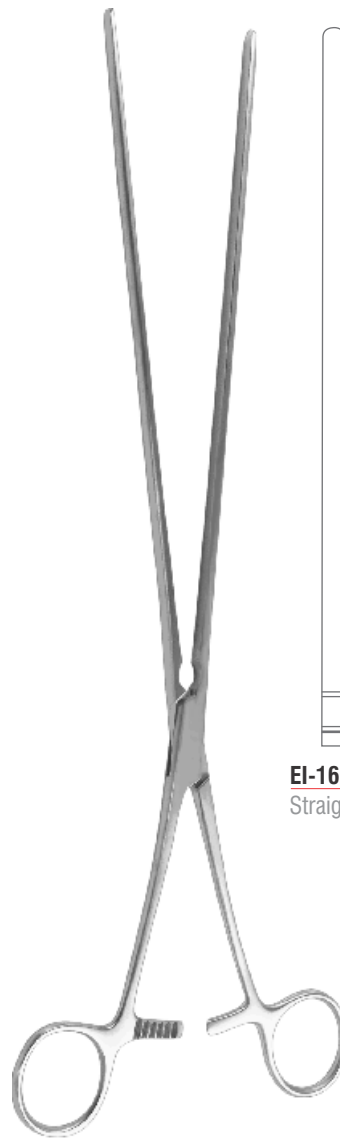

Scudder Intestinal Clamp

EI-160-33
Straight

EI-161-33
Curved

Intestinal Clamps
Darmklemmen
Pinzas intestinales
Pinces intestinales
Pinze intestinali

EVA

STOMACH, INTESTINES, RECTUM

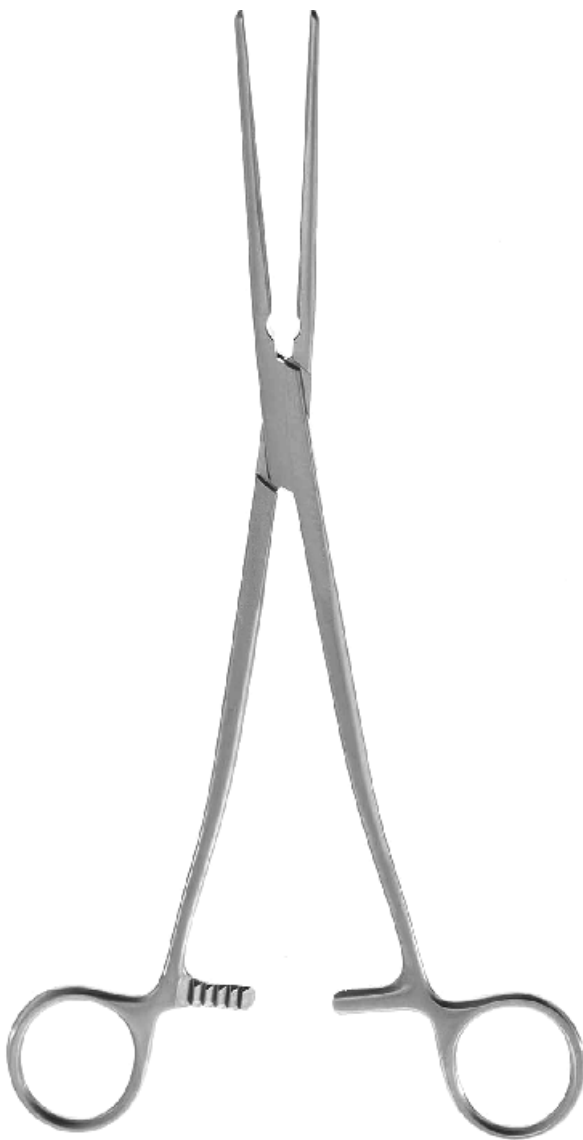

EI-162-23
Dennis Anastomosis Clamp
Straight, Longitudinal Serrations
Overall Length 23 cm (9")

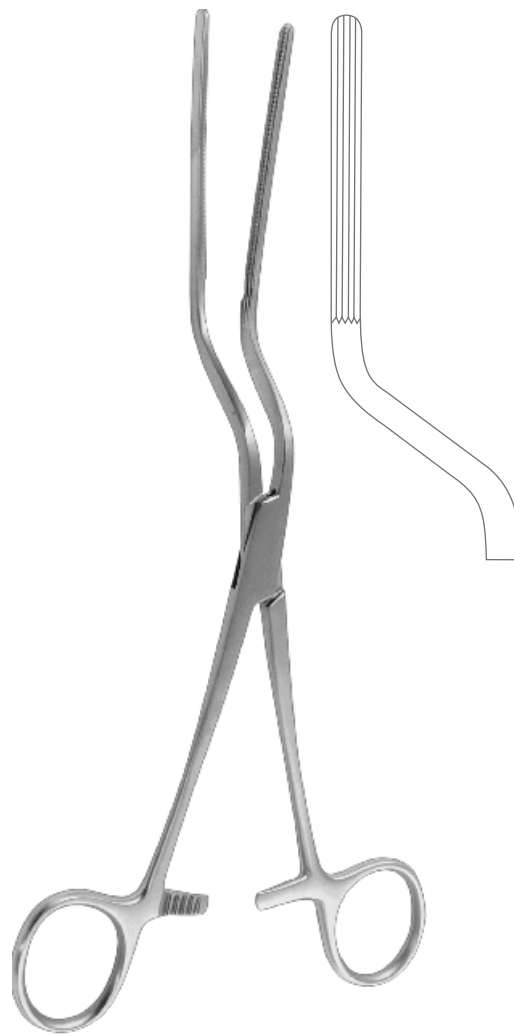

EI-165-24
Brunner Sigmoid Anastomosis Clamp
Overall Length 24 cm (9 1/2")

Intestinal Clamps
Darmklemmen
Pinzas intestinales
Pinces intestinales
Pinze intestinali



EI-1EI-31
Lloyd-Davis Rectal Occlusion Forcep
Overall Length 31.5 cm (12 1/2")

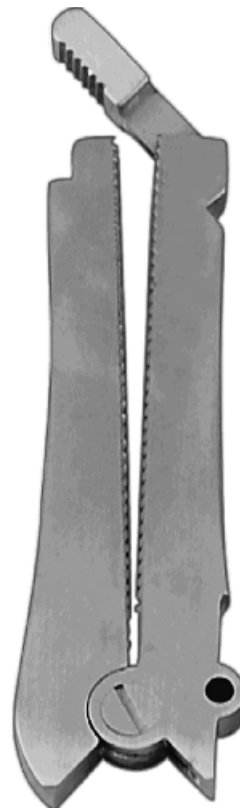

EI-170-00
De Martel-Wolfson Intestinal Anastomosis Clamp
Set of 3 Ref: EI-172-01 to EI-172-03



EI-172-01
65 mm

EI-172-02
80 mm

EI-172-03
110 mm

Intestinal Clamps
Darmklemmen
Pinzas intestinales
Pinces intestinales
Pinze intestinali



EI-179-25
De Martel-Wolfson Closing Forcep
Overall Length 25 cm (9 3/4")



EI-180-09
9.5 cm (3 3/4")
EI-180-23
23 cm (9")

De Martel-Wolfson Closing Forcep



EI-186-15
Benson Pylorus Spreader
Overall Length 15.5 cm (6")

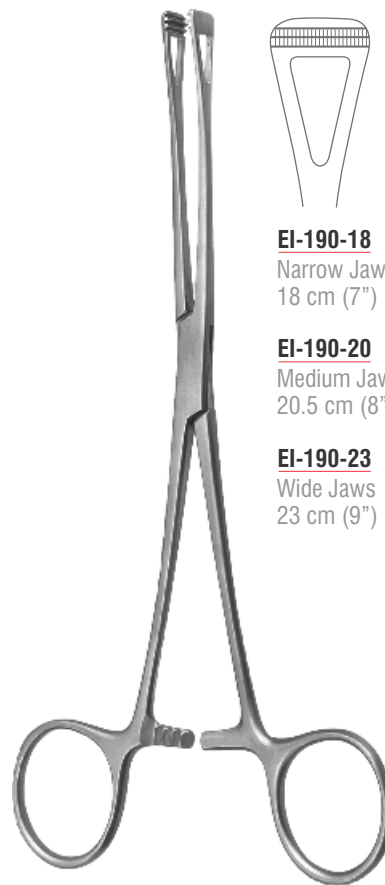

EI-190-18
Narrow Jaws
18 cm (7")

EI-190-20
Medium Jaws
20.5 cm (8")

EI-190-23
Wide Jaws
23 cm (9")

Scheibe (Collin) Atrauma Organ Grasping



EVA

STOMACH, INTESTINES, RECTUM

Intestinal Clamps
Darmklemmen
Pinzas intestinales
Pincas intestinales
Pinze intestinali

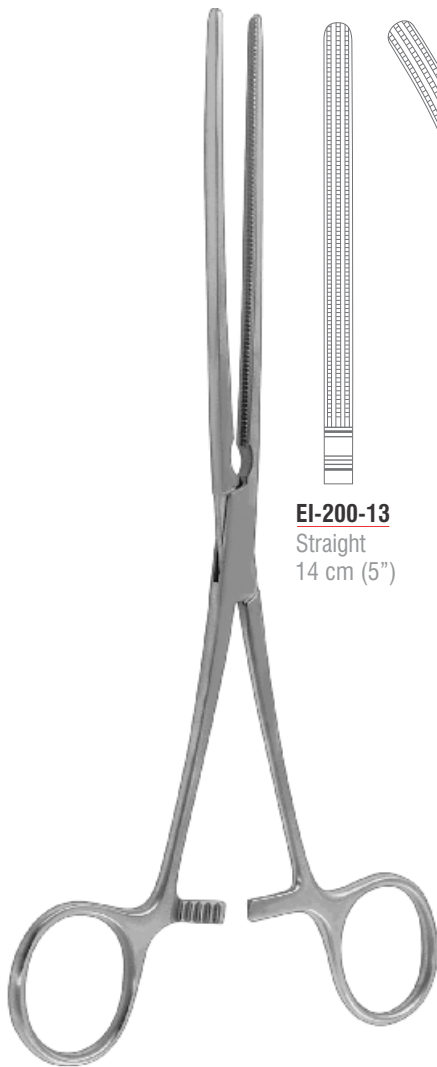

Doyen-Baby Atrauma Intestinal Clamp



EI-200-13
Straight
14 cm (5")



EI-201-13
Curved
13.5 cm (4 3/4")

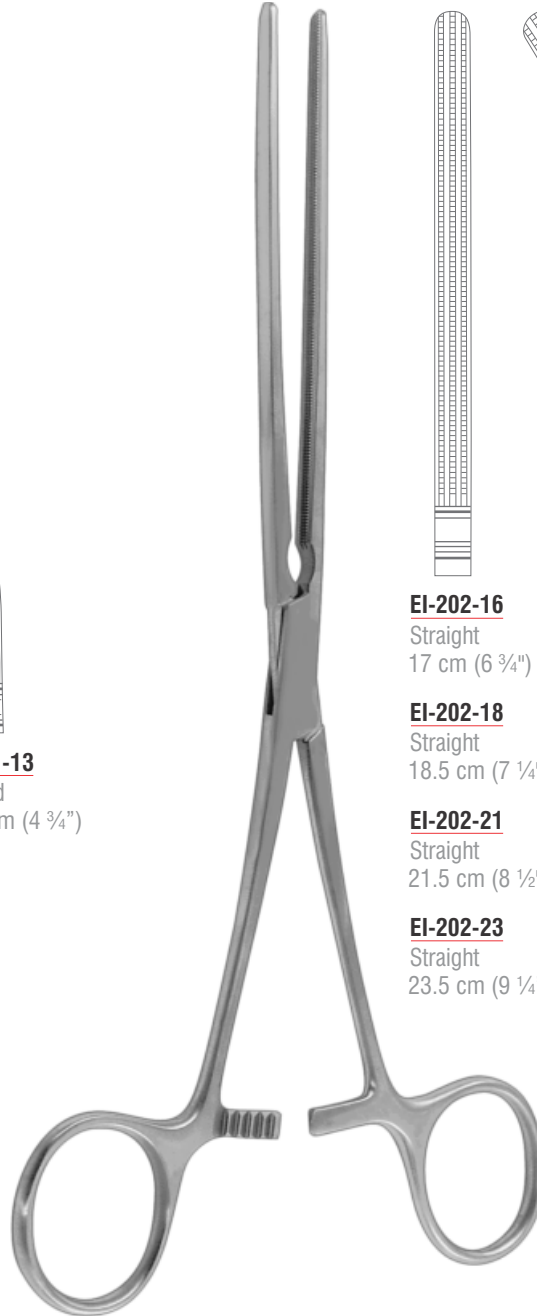
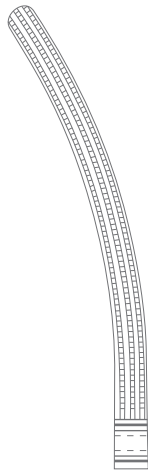

Doyen Atrauma Intestinal Clamp



EI-202-16
Straight
17 cm (6 3/4")



EI-202-18
Straight
18.5 cm (7 1/4")

EI-202-21
Straight
21.5 cm (8 1/2")

EI-202-23
Straight
23.5 cm (9 1/4")

EI-203-16
Curved
17 cm (6 3/4")

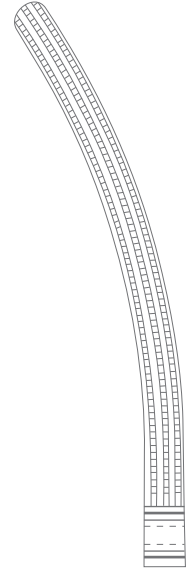

EI-203-18
Curved
18 cm (7")

EI-203-21
Curved
21 cm (8 1/4")

EI-203-23
Curved
23 cm (9")

Intestinal Clamps
Darmklemmen
Pinzas intestinales
Pinces intestinales
Pinze intestinali

EVA

STOMACH, INTESTINES, RECTUM

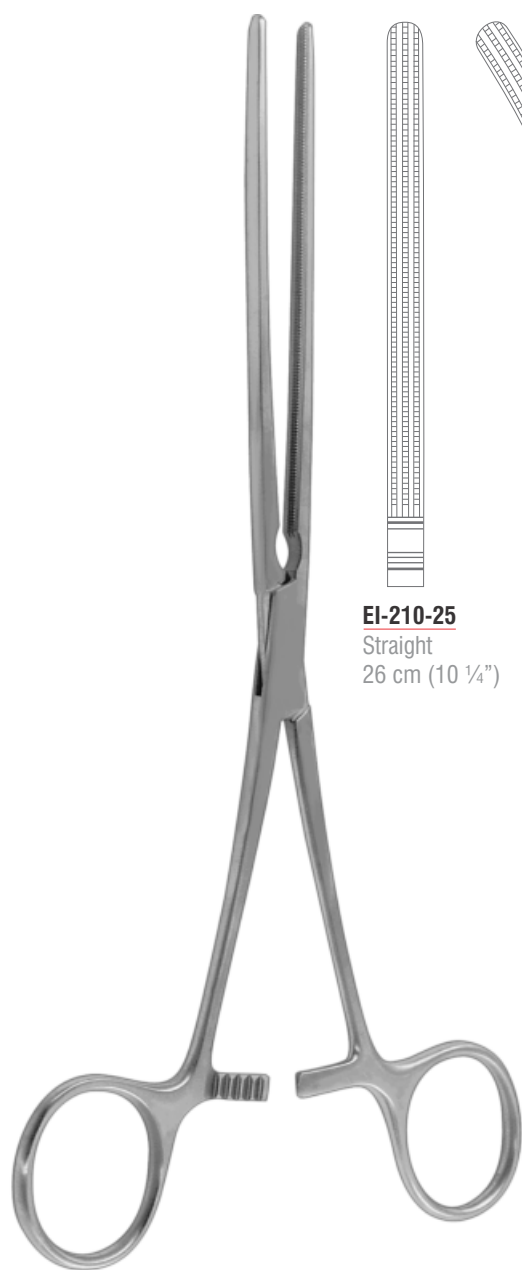

EI-210-25
Straight
26 cm (10 1/4")

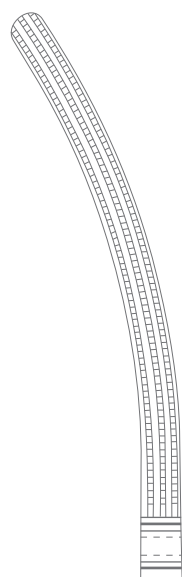

EI-211-25
Curved
25 cm (9 3/4")

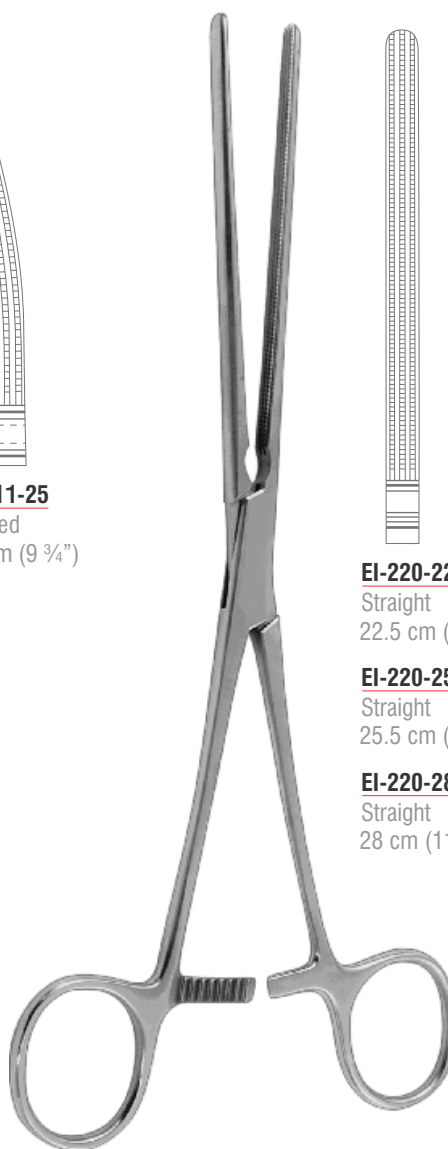

EI-220-22
Straight
22.5 cm (8 3/4")

EI-220-25
Straight
25.5 cm (10")

EI-220-28
Straight
28 cm (11")

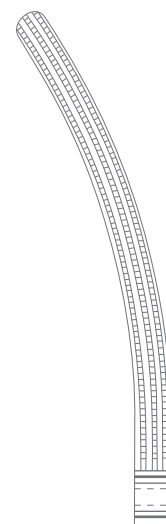

EI-221-22
Curved
22 cm (8 3/4")

EI-221-25
Curved
25 cm (9 3/4")

EI-221-28
Curved
27.5 cm (10 3/4")

Mayo-Robson Atrauma Intestinal Clamp

Mayo-Robson Atrauma Intestinal Clamp

Atrauma™

Atrauma™

Intestinal Clamps
Darmklemmen
Pinzas intestinales
Pinces intestinales
Pinze intestinali

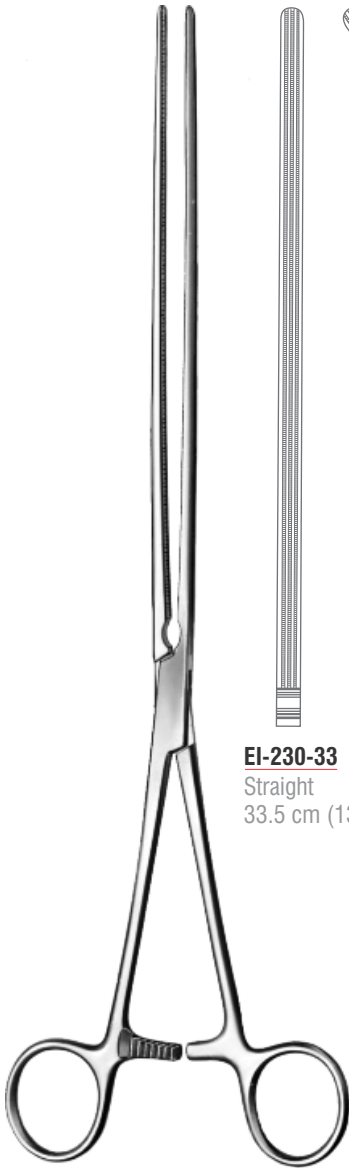

EI-230-33
Straight
33.5 cm (13 1/4")

Scudder Atrauma Intestinal Clamp

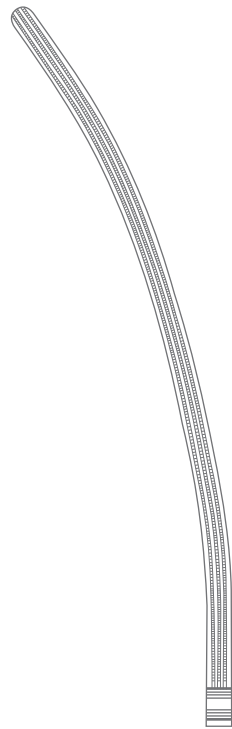

EI-231-33
Curved
32.5 cm (12 3/4")

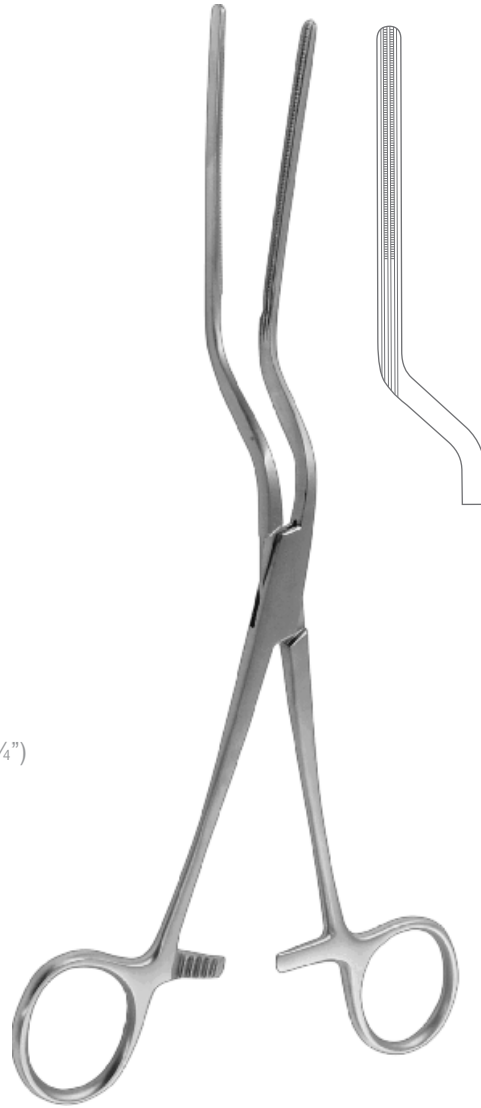

EI-241-27
Brunner Atrauma Sigmoid Anastomosis Clamp
Overall Length 27 cm (10 3/4")



Intestinal Clamps
Darmklemmen
Pinzas intestinales
Pincas intestinales
Pinze intestinali

EVA

STOMACH, INTESTINES, RECTUM



EI-251-26
27 cm (10 3/4")

EI-251-28
28 cm (11")

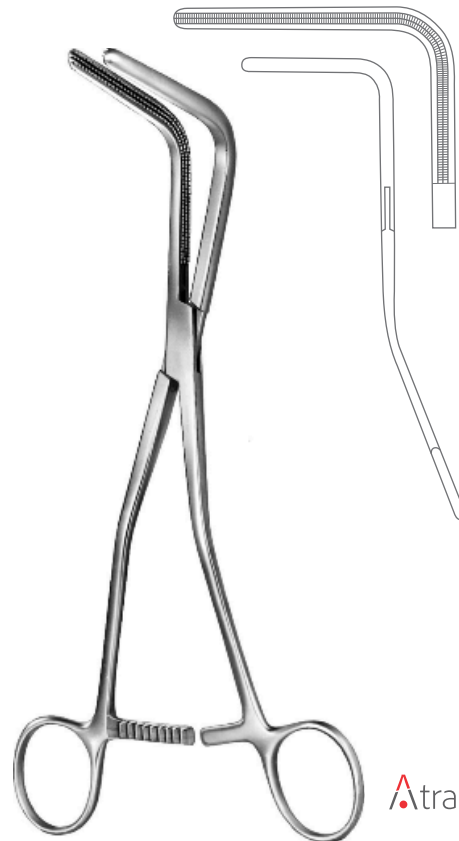

Atrauma™

EI-255-23
Veidenheimer Atrauma Sigmoid Anastomosis Clamp
Overall Length 25 cm (9 3/4")

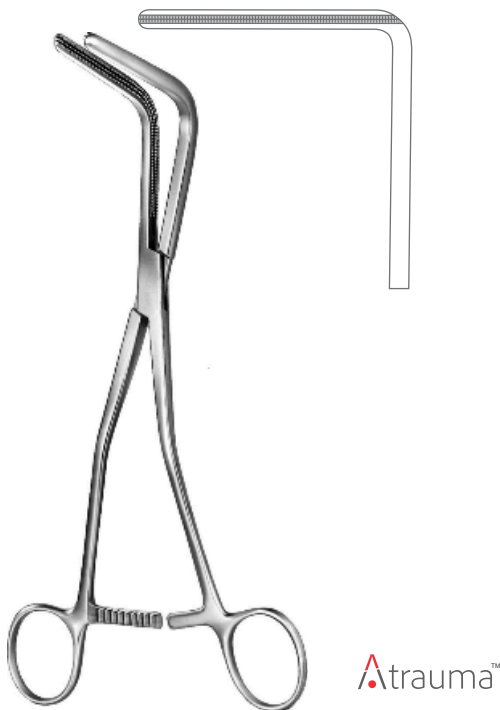

Atrauma™

EI-259-24
Fehland Atrauma Sigmoid Anastomosis Clamp
Overall Length 24 cm (9 1/2")

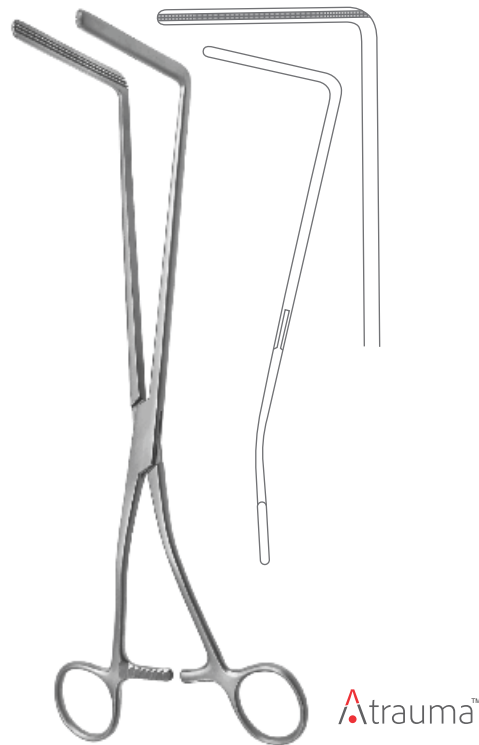

Atrauma™

EI-261-30
Resano Atrauma Sigmoid Anastomosis Clamp
Overall Length 28 cm (11")



Rectal Specula
Mastdarmspekula
Espéculos rectales
Spéculums rectaux
Specoli rettali



EI-290-30
28 cm (11")
EI-290-48
48 cm (19")

Savage Intestinal Decompressor
Ø 8.0 mm

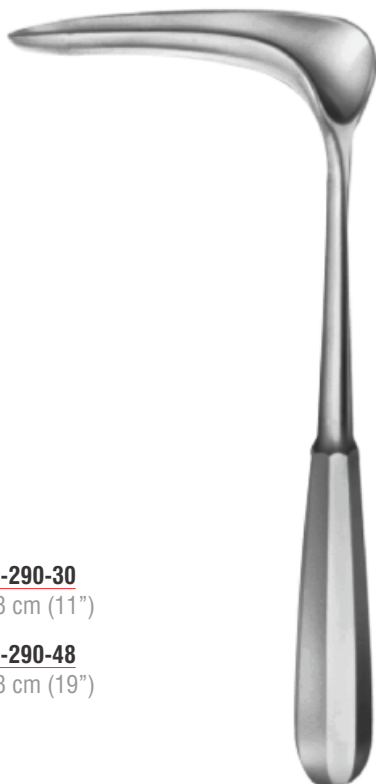

EI-301-22
Czerny Rectal Speculum
Overall Length 22 cm (8 3/4")



Hill-Ferguson Rectal Speculum
Overall Length 21 cm (8 1/4")

EI-303-22
22 x 64 mm

EI-303-30
30 x 76 mm

EI-303-36
36 x 76 mm



EI-311-20
Pratt Rectal Speculum
80 x 25 mm
Overall Length 20.5 cm (8")



Sims Rectal Speculum
Overall Length 15.5 cm (6")

EI-321-15
70 x 15 mm

EI-323-15
70 x 15 mm
With Fiber Optic
Illumination



EI-327-15
Sims Rectal Speculum
70 x 15 mm
Overall Length 15.5 cm (6")

Rectal Specula
Mastdarmspekula
Espéculos rectales
Spéculums rectaux
Specoli rettali

EVA

STOMACH, INTESTINES, RECTUM

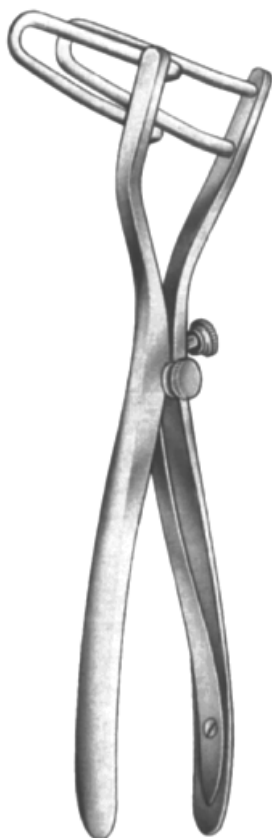

EI-331-01
60 mm

EI-331-02
80 mm

EI-331-03
125 mm

EI-331-04
150 mm

EI-335-22
With Fiber Optic
Illumination



EI-341-19
Mathieu Rectal Speculum
90.0 mm
Overall Length 19.5 cm (7 3/4")



EI-343-17
Barr Rectal Speculum
70 x 22 mm
Overall Length 17 cm (6 3/4")

Sims (Schulze-Bergmann) Rectal Speculum
Overall Length 22 cm (8 3/4")



EI-351-00
Parks Rectal Speculum

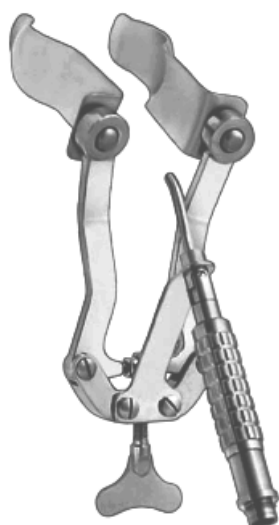

EI-355-00
Parks Rectal Speculum
With Fiber Optic Illumination

Rectal Specula, Anuscope
Mastdarmspekula, Anoskop
Espéculos rectales, Anoscopio
Spéculum rectaux, Anuscope
Specoli rettali, Anuscopio



EI-361-00
AIEI-Parks Rectal Speculum



EI-365-00
AIEI-Parks Rectal Speculum
With Fiber Optic Illumination



Hirschmann Anoscope

- EI-381-01**
Fig. 1
Ø 16 mm, 60 mm
- EI-381-02**
Fig. 2
Ø 19 mm, 70 mm
- EI-381-03**
Fig. 3
Ø 24 mm, 90 mm
- EI-381-04**
Fig. 4
Ø 24 mm, 130 mm



Hirschman Anoscope
With Fiber Optic Illumination

- EI-385-01**
Fig. 1
Ø 16 mm, 60 mm
- EI-385-02**
Fig. 2
Ø 19 mm, 70 mm
- EI-385-03**
Fig. 3
Ø 24 mm, 90 mm
- EI-385-04**
Fig. 4
Ø 24 mm, 130 mm

Anuscope
Anuskop
Anoscopio
Anuscope
Anoscopio

EVA

STOMACH, INTESTINES, RECTUM



EI-391-00
Ives-Fansler Anoscope
Ø 22 mm, 95 mm

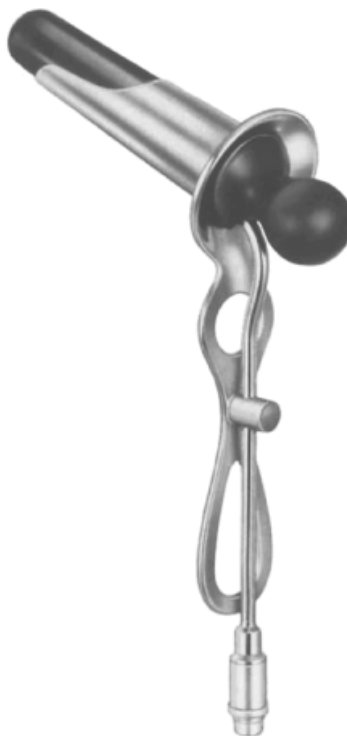

EI-395-00
Ives-Fansler Anoscope
With Fiber Optic Illumination
Ø 22 mm, 95 mm



EI-401-00
Anoscope
With Obturator
Ø 21 mm, 80 mm



EI-403-01
Ø 26 mm, 60 mm

EI-403-02
Ø 24 mm, 80 mm

Anoscope
With Obturator



EI-411-01
Fig. 1
Ø 22 mm, 50 mm

EI-411-02
Fig. 2
Ø 22 mm, 100 mm

EI-411-03
Fig. 3
Ø 22 mm, 140 mm

EI-411-04
Fig. 4
Ø 22 mm, 200 mm

Kelly Proctoscope



Anuscope
Anuskop
Anoscopio
Anuscope
Anuscopio



EI-415-00
Proctoscope
With Obturator
Ø 22 mm, 120 mm



Morgan Proctoscope
With Fiber Optic Illumination

EI-451-01
Ø 17 mm, 65 mm

EI-451-02
Ø 17 mm, 80 mm

EI-451-03
Ø 20 mm, 65 mm

EI-451-04
Ø 20 mm, 80 mm

EI-451-05
Ø 24 mm, 65 mm

EI-451-06
Ø 24 mm, 80 mm



Kelly Sphincteroscope

EI-471-01
Fig. 1
Ø 21 mm, 50 mm

EI-471-02
Fig. 2
Ø 27 mm, 50 mm

Rectoscopes
Rektoskope
Rectoscopios
Rectoscopes
Rectotoscopi

STOMACH, INTESTINES, RECTUM

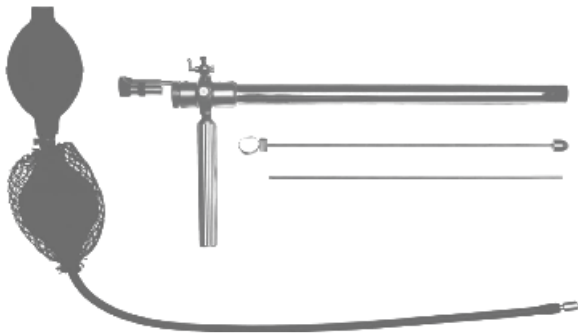

EI-500-00
Rectoscope Complete

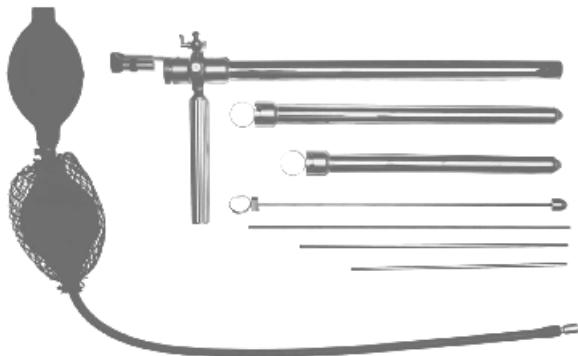

EI-510-00
Strauss Rectoscope Complete

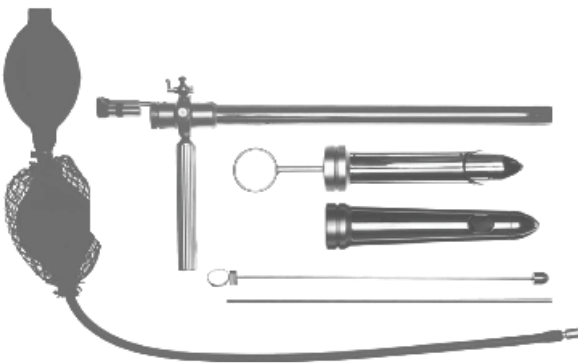

EI-520-00
Recto-Proctoscope Complete

Hemorrhoidal Ligator
Hämorrhoidal-Faßzange
Ligador para hemorroides
Ligateur pour hémorroïdes
Legatore emorroidale



EI-601-30
Norwood Rectal Snare
Overall Length 30 cm (11 3/4")



EI-607-40
Blue Rectal Aspiration Cannula
10 Charr. Ø 3.3 mm
Overall Length 40 cm (15 3/4")



EI-651-00
McGiveny Suction Hemorrhoidal Ligator Complete
With 10 mm Suction Head and Charging Cone



EI-655-00
Angled 30° Up

EI-657-00
Angled 30° Down

Suction Hemorrhoidal Ligature Complete
With 10 mm Suction Head and Charging Cone

Hemorrhoidal Ligator
Hämorrhoidal-Faßzange
Ligador para hemorroides
Ligateur pour hémorroïdes
Legatore emorroidale

EVA

STOMACH, INTESTINES, RECTUM



EI-670-00
Rudd Hemorrhoidal Ligator Complete
With 12 mm Charging Cone
Overall Length 31.5 cm (12 1/2")



EI-675-00
McGivney Hemorrhoidal Ligator Complete
With 12 mm Charging Cone



EI-677-00
Ford Dixon Hemorrhoidal Ligator Complete
With 12 mm Charging Cone
Overall Length 31.5 cm (12 1/2")



EI-680-00
Rubber Ligator Rings
Pack of 100

Hemorrhoidal Ligator, Rectal Biopsy Forceps
 Hämorrhoidal-Faßzange, Rektum-Biopsiefasszangen
 Ligador para hemorroides, Pinzas para biopsia rectal
 Ligateur pour hémorroides, Pincés pour biopsie rectale
 Legatore emorroidale, Pinze per biopsia rettale

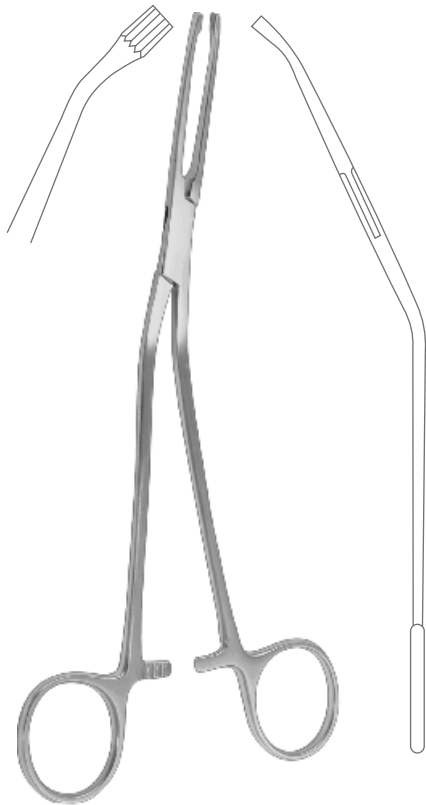

EI-691-19
McGiveny Hemorrhoidal Grasping Forcep
 Overall Length 19 cm (7 1/2")



Yeoman (Turrell) Rectal Biopsy Forcep Complete
 Overall Length 42 cm (16 1/2")



EI-735-01
 Straight



EI-735-02
 Down



EI-735-03
 Straight



EI-735-04
 Down



EI-735-05
 Straight

Kidney Stone Forceps
Nierensteinzangen
Pinzas para cálculos renales
Pincers pour les calculs du bassinet
Pinze per calcoli renali



EI-011-01
Vasectomy Dissecting Forcep
Overall Length 14.5 cm (5 3/4")



EI-014-02
Vasectomy Fixation Forcep
Overall Length 14.5 cm (5 3/4")



EI-031-01
Angled Right

EI-031-02
Angled Left

McDougal Prostatectomy Clamp
Overall Length 25.5 cm (10")

Kidney Stone Forceps
Nierensteinzangen
Pinzas para cálculos renales
Pinces pour les calculs du bassin
Pinze per calcoli renali



EI-051-23
Fig. 1
23 cm (9")

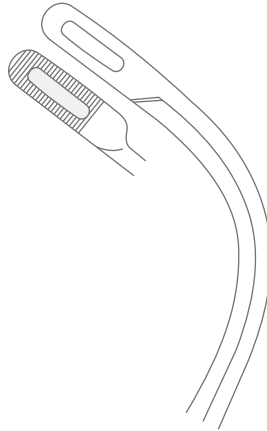

EI-053-21
Fig. 2
21 cm (8 1/4")

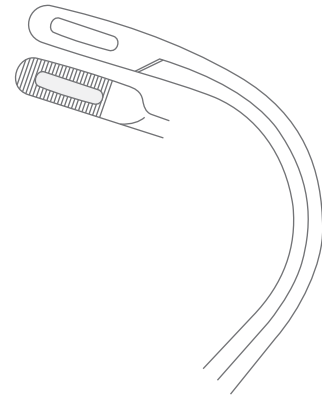

EI-055-19
Fig. 3
19 cm (7 1/2")

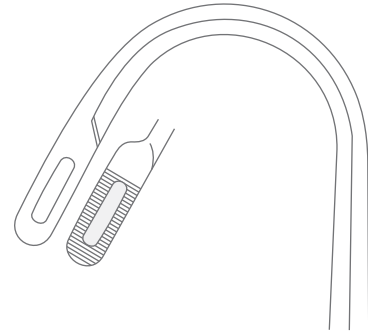

EI-057-18
Fig. 4
18.5 cm (7 1/2")

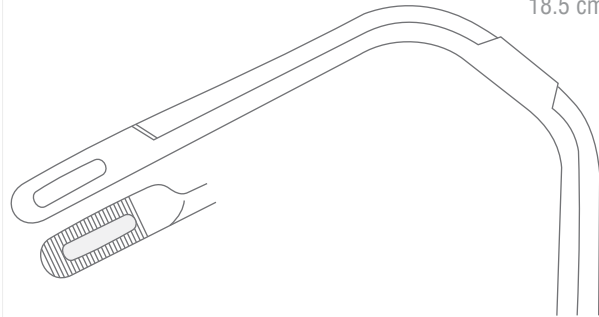

EI-059-19
Fig. 5
19 cm (7 1/2")

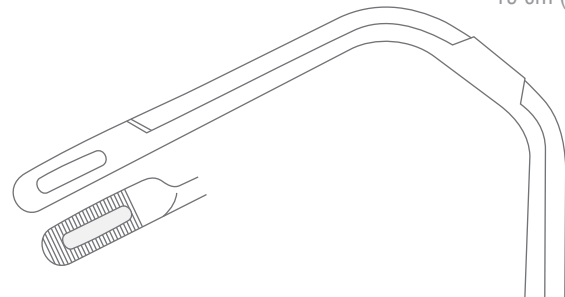

EI-061-19
Fig. 6
19 cm (7 1/2")



Randall Kidney Stone Forcep



Kidney Stone Forceps
Nierensteinzangen
Pinzas para cálculos renales
Pincers pour les calculs du bassinet
Pinze per calcoli renali



Randall Kidney Stone Forcep
Slender Pattern

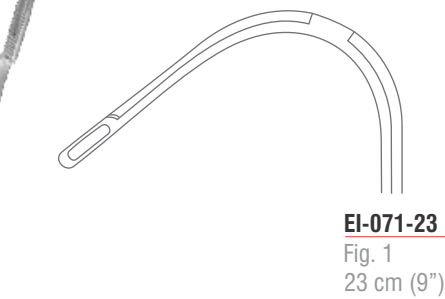

EI-071-23
Fig. 1
23 cm (9")

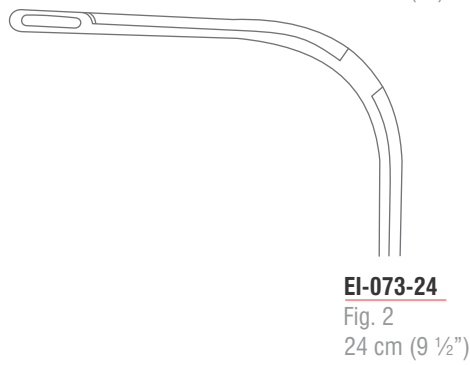

EI-073-24
Fig. 2
24 cm (9 1/2")



Heiming Kidney Stone Forcep

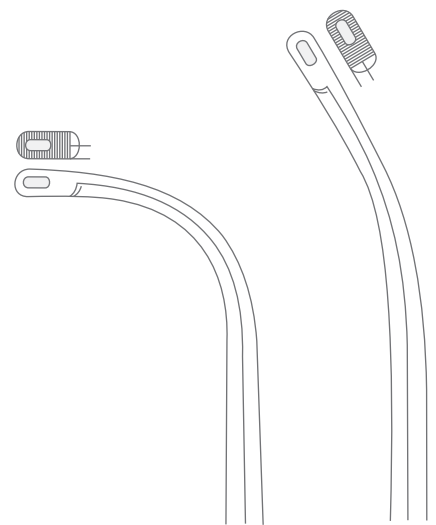

EI-081-16
Fig. 1
16 cm (6 1/4")

EI-083-17
Fig. 1
17 cm (6 3/4")

Kidney Stone Forceps
Nierensteinzangen
Pinzas para cálculos renales
Pinces pour les calculs du bassin
Pinze per calcoli renali



Elsaesser Nephrectomy Forcep
Overall Length 21 cm (8 1/4")

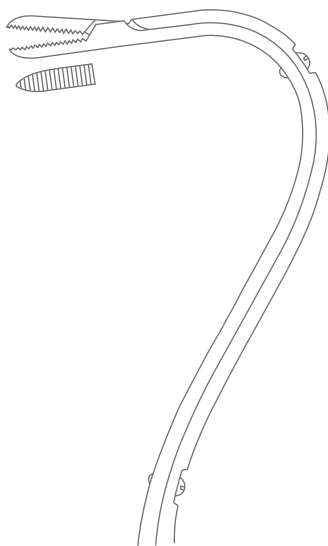

EI-091-01
Fig. 1

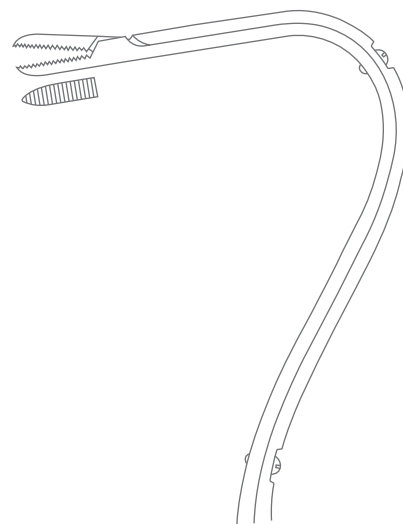

EI-091-02
Fig. 2

Gall Duct Dilators
 Gallenkanaldilatatore
 Dilatadores para conducto biliar
 Dilatateurs pour les voies biliaires
 Dilatatori per condotti biliari



EI-150-00
Bakes Gall Duct Dilators
 Set of 13 Ref: EI-150-01 to EI-150-13



Bakes Gall Duct Dilators
 Overall Length 32 cm (12 1/2")

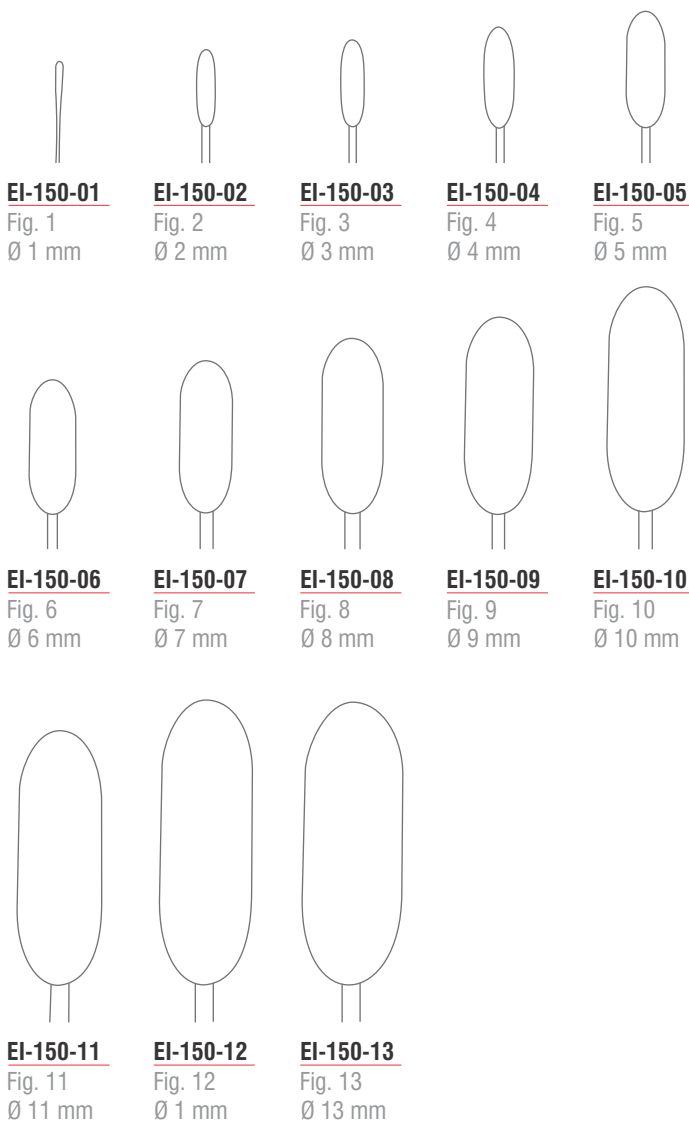

Gall Stone Forceps
Gallensteinzangen
Pinzas para cálculos biliares
Pincès pour calculs biliaires
Pinze per calcoli biliari



Bakes Gall Stone Forcep
Overall Length 21 cm (8 1/4")

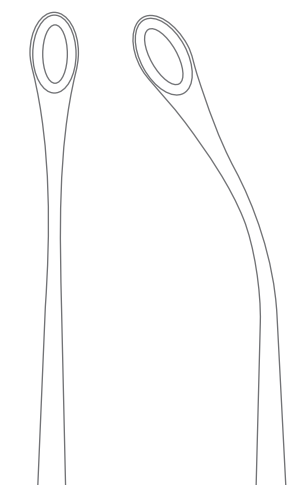

EI-180-20
Straight

EI-181-20
Curved



Mayo-Bakes Gall Stone Forcep
Overall Length 21 cm (8 1/4")

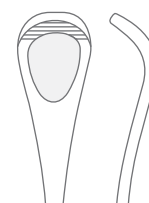

EI-184-20
Straight

EI-185-20
Curved

Gall Stone Forceps
Gallensteinzangen
Pinzas para cálculos biliares
Pinces pour calculs biliaires
Pinze per calcoli biliari



EI-189-22
Mixer Gall Stone Forcep
Overall Length 22 cm (8 3/4")



EI-191-23
Fig. 1

EI-193-23
Fig. 2

Desjardins Gall Stone Forcep
Overall Length 23 cm (9")

Prostatic Retractors
 Prostatahaken
 Separadores para próstata
 Ecarteurs prostatiques
 Divaricatori prostatici



Luer-Koerte Gall Stone Scoop
 Overall Length 32 cm (12 1/2")



EI-250-01
 Fig. 000
 Ø 2.7 mm



EI-250-02
 Fig. 00
 Ø 3.4 mm



EI-250-03
 Fig. 0
 Ø 4.3 mm



EI-250-04
 Fig. 1
 Ø 5.5 mm



EI-250-05
 Fig. 2
 Ø 6.6 mm



EI-250-06
 Fig. 3
 Ø 8.0 mm



EI-250-07
 Fig. 4
 Ø 11.0 mm



EI-250-08
 Fig. 5
 Ø 15.0 mm



Desjardins Gall Duct Probe and Gall Stone Scoop
 Overall Length 30 cm (12")



EI-252-06
 Ø 6.0 mm

EI-252-07
 Ø 7.0 mm

EI-252-08
 Ø 8.0 mm

EI-252-09
 Ø 9.0 mm

Prostatic Retractors
Prostatahaken
Separadores para próstata
Ecarteurs prostatiques
Divaricatori prostatici



EI-260-35
Moynihan Gall Stone Probe and Scoop
Malleable Tip Ø 5.0 mm
Overall Length 36.5 cm (14 ½")



EI-262-27
Moyo Gall Stone Scoop
Overall Length 27.5 cm (10 ¾")



EI-264-28
Moore Gall Stone Scoop
Overall Length 28 cm (11")



EI-290-15
15 Fr.
EI-290-18
18 Fr.
EI-290-20
20 Fr.
Desjardins Gall Stone Probe
Overall Length 28 cm (11")

Prostatic Retractors
 Prostatahaken
 Separadores para próstata
 Ecarteurs prostatiques
 Divaricatori prostatici



Young Prostatic Retractor

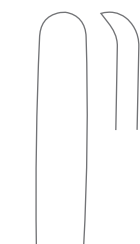

EI-301-22
22 cm (8 3/4")



EI-305-21
21.5 cm (8 1/2")

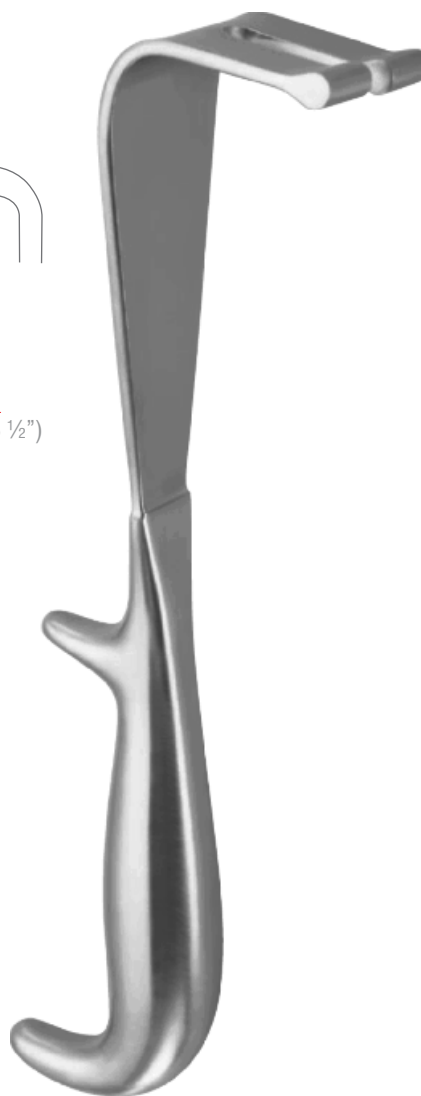

EI-309-23
Young Prostatic Retractor
 Overall Length 23 cm (9")

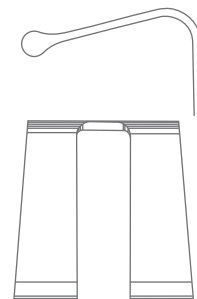

Capsule Forceps
Kapselasszangen
Pinzas capsulares
Pincers pour saisir les capsules
Pinze per afferrare capsule



Atrauma™

EI-451-24
Martin Atrauma Capsule Forcep
Overall Length 24.5 cm (9 1/2")

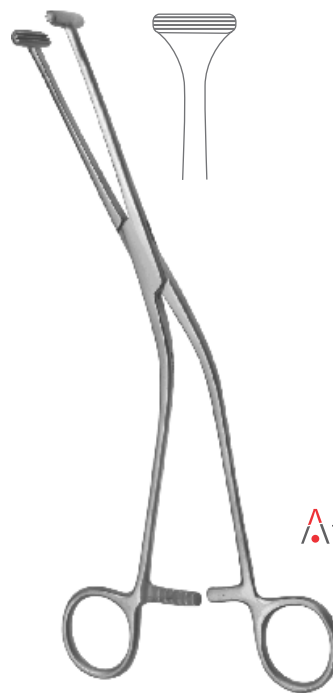

Atrauma™

EI-453-22
Millin Atrauma Capsule Forcep
Overall Length 22.5 cm (8 3/4")

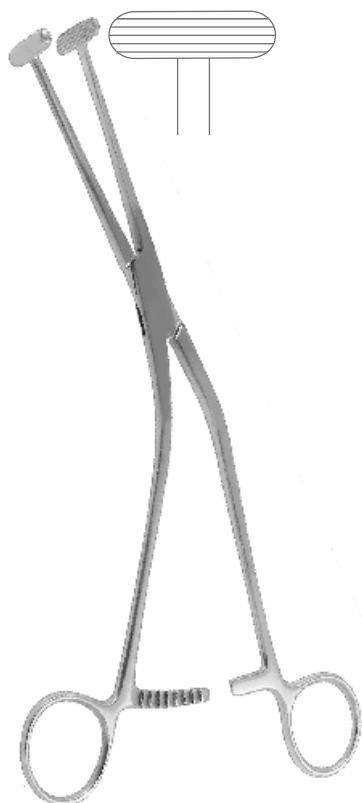

EI-457-24
Millin Capsule Forcep
Overall Length 24.5 cm (9 1/2")

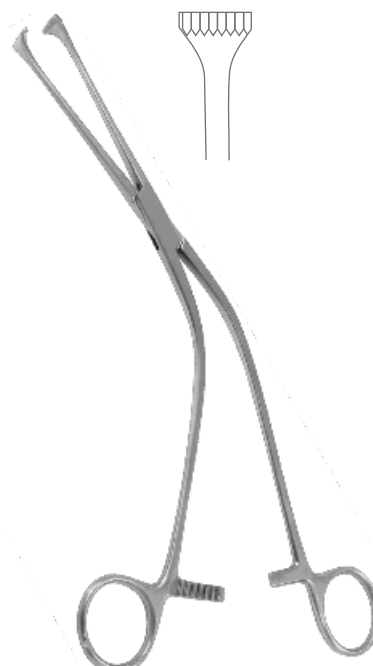

EI-461-22
Millin Capsule Forcep
Overall Length 22 cm (8 3/4")

Urethral Sounds
 Harnröhrenbougies
 Bujías uretrales
 Bougies urétrales
 Candelette dilatatrici



EI-501-00
Van Buren Urethral Sound / Dilating Bougie
 Set of 15 Ref: EI-501-08 to EI-501-36



Van Buren Urethral Sound / Dilating Bougie
 Overall Length 27 cm (10 3/4")

- | | |
|--------------------------------------|--------------------------------------|
| <u>EI-501-08</u>
8 Charr. | <u>EI-501-24</u>
24 Charr. |
| <u>EI-501-10</u>
10 Charr. | <u>EI-501-26</u>
26 Charr. |
| <u>EI-501-12</u>
12 Charr. | <u>EI-501-28</u>
28 Charr. |
| <u>EI-501-14</u>
14 Charr. | <u>EI-501-30</u>
30 Charr. |
| <u>EI-501-16</u>
16 Charr. | <u>EI-501-32</u>
32 Charr. |
| <u>EI-501-18</u>
18 Charr. | <u>EI-501-34</u>
34 Charr. |
| <u>EI-501-20</u>
20 Charr. | <u>EI-501-36</u>
36 Charr. |
| <u>EI-501-22</u>
22 Charr. | |

Urethral Sounds
Harnröhrenbougies
Bujías uretrales
Bougies urétrales
Candelette dilatatrici

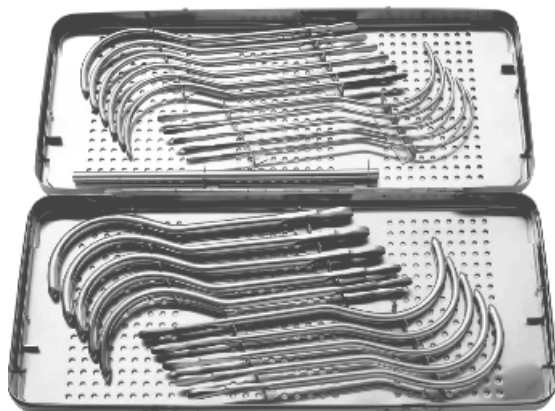

EI-511-00

Guyon Urethral Sound/Dilating Bougie

Set of 24 Ref: EI-511-10 to EI-511-30 and EI-580-03 to EI-580-06 in Metal Case



EI-511-10

10 Charr.

EI-511-20

20 Charr.

EI-511-11

11 Charr.

EI-511-21

21 Charr.

EI-511-12

12 Charr.

EI-511-22

22 Charr.

EI-511-13

13 Charr.

EI-511-23

23 Charr.

EI-511-14

14 Charr.

EI-511-24

24 Charr.

EI-511-15

15 Charr.

EI-511-25

25 Charr.

EI-511-16

16 Charr.

EI-511-26

26 Charr.

EI-511-17

17 Charr.

EI-511-27

27 Charr.

EI-511-18

18 Charr.

EI-511-28

28 Charr.

EI-511-19

19 Charr.

EI-511-30

30 Charr.



EI-515-10

10 Charr.

EI-515-12

12 Charr.

EI-515-14

14 Charr.

EI-515-16

16 Charr.

EI-515-18

18 Charr.

EI-515-20

20 Charr.

Guyon Urethral Sound / Dilating Bougie

Overall Length 26.5 cm (10 1/2")

Female Catheter

Overall Length 15 cm (6")

Urethrotome
Urethrotom
Uretrótomo
Urétrotome
Uretrotomi,



EI-519-00
Catheter Introducer
Overall Length 46 cm (18")



EI-550-00
Otis Urethrotome
With 2 Knives and 3 Tips



EI-550-01
Otis Spare Blade



EI-700-00
Knutson Urethrography Instrument

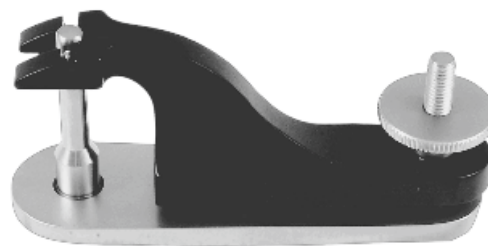

Gomco Circumcision Clamp

EI-720-08

Ø 8 mm

EI-720-11

Ø 11 mm

EI-720-13

Ø 13 mm

EI-720-16

Ø 16 mm

EI-720-21

Ø 21 mm

EI-720-26

Ø 26 mm

EI-720-32

Ø 32 mm

Circumcision Instruments
Circumcisions-Instrumente
uretrografía y circuncisión
urétrographie et circoncision
uretrografia e circoncisione



EI-740-00
Mogen Circumcision Clamp
Overall Length 7.5 cm (3")

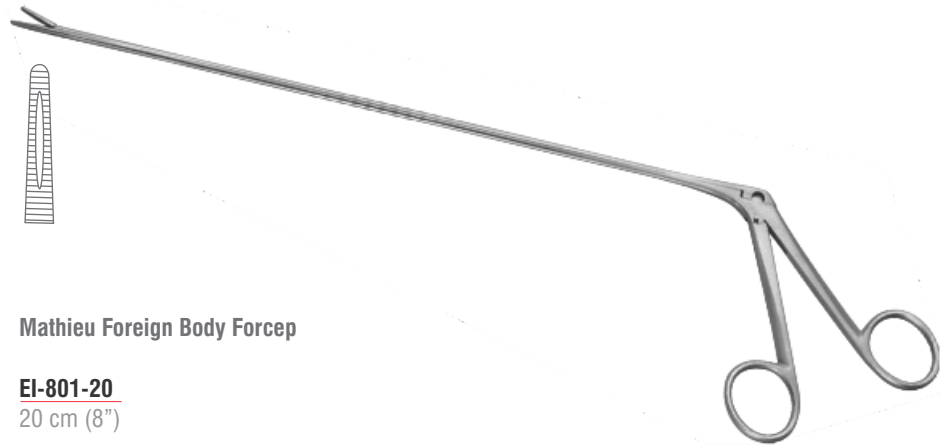

Mathieu Foreign Body Forcep

EI-801-20
20 cm (8")

EI-801-28
28 cm (11")

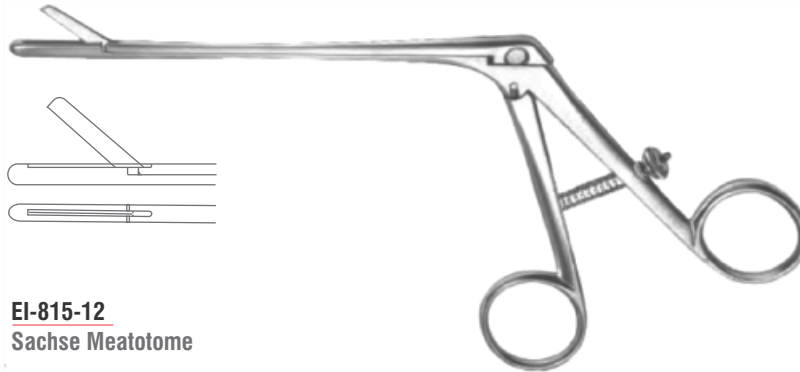

EI-815-12
Sachse Meatotome

Circumcision Instruments
 Circumcisions-Instrumente
 uretrografia y circuncisión
 urétrographie et circoncision
 uretrografia e circoncisione



EI-851-08
Stockman Penis Clamp
 Overall Length 8 cm (3 1/4")



EI-861-11
Strauss Penis Clamp
 Overall Length 11 cm (4 1/2")



EI-870-13
Collingwood-Stewart Hernia Ring Forcep
 Overall Length 13 cm (5")



Round Bowls
Runde Schüsseln
Cubetas redondas
Cuvettes rondes
Scodelle rotonde



Round Bowl

EI-010-16

Ø 150 x 74 mm, 750 ccm

EI-010-17

Ø 160 x 65 mm, 1000 ccm

EI-010-22

Ø 220 x 70 mm, 2000 ccm

EI-010-24

Ø 240 x 95 mm, 3000 ccm

EI-010-27

Ø 260 x 130 mm, 4500 ccm

EI-010-31

Ø 300 x 105 mm, 6000 ccm

EI-010-34

Ø 320 x 140 mm, 8500 ccm

EI-010-38

Ø 380 x 125 mm, 11000 ccm

EI-010-41

Ø 400 x 150 mm, 14000 ccm



Round Bowl

EI-020-33

Ø 330 x 90 mm, 6000 ccm

EI-022-33

Ø 330 x 115 mm, 8000 ccm



Round Bowl

EI-0EI-11

Ø 110 x 25 mm, 150 ccm

EI-028-11

Ø 110 x 40 mm, 250 ccm

Round Bowls, Flat Dishes
 Runde Schüsseln, Flachschaalen
 Cubetas redondas, Cubetas planas
 Cuvettes rondes, Cuvettes plates
 Scodelle rotonde, Scodelle piatte



EI-030-11
 Lid Only



Mixing Bowl/ Solution Bowl



Round Dish

EI-050-04

Ø 40 x 19 mm, 20 ccm

EI-050-12

Ø 128 x 55 mm, 350 ccm

EI-050-06

Ø 61 x 30 mm, 70 ccm

EI-050-14

Ø 147 x 65 mm, 500 ccm

EI-050-08

Ø 80 x 40 mm, 140 ccm

EI-050-16

Ø 167 x 75 mm, 900 ccm

EI-050-11

Ø 116 x 50 mm, 250 ccm

EI-050-18

Ø 187 x 85 mm, 1300 ccm

EI-060-11

Ø 116 x 35 mm, 200 ccm

EI-060-16

Ø 167 x 45 mm, 500 ccm

EI-060-12

Ø 128 x 38 mm, 300 ccm

EI-060-18

Ø 187 x 45 mm, 800 ccm

EI-060-14

Ø 147 x 40 mm, 400 ccm



Measurers, Universal Trays
Messbecher, Mehrzweckschalen
Vaso-medidas, Bandejas universales
Mesures graduées, Plateaux universaux
Bicchieri graduati, Bacinelle universali



EI-064-11
Round Dish
Ø 110 x 28 mm, 150 ccm



EI-070-01
Graduated Measure
100 ccm



Graduated Measure

EI-072-01
250 ccm

EI-072-02
500 ccm

EI-072-03
1000 ccm

EI-072-04
2000 ccm



Petri Dish

EI-090-00
Ø 100 x 20 mm, With Lid

EI-090-01
Ø 96 x 20 mm, Without Lid

EI-090-02
Lid Only



Universal Tray

EI-100-23
230 x 155 x 30 mm

EI-100-35
350 x 240 x 36 mm

EI-100-30
300 x 175 x 30 mm

EI-100-40
470 x 320 x 50 mm

EI-100-31
300 x 175 x 40 mm



Instrument Tray

EI-110-21
210 x 160 x 10 mm

EI-110-35
350 x 240 x 10 mm

EI-110-24
240 x 180 x 10 mm

EI-110-40
400 x 270 x 20 mm

EI-110-30
310 x 150 x 10 mm

EI-110-42
420 x 280 x 10 mm

EI-110-31
310 x 210 x 10 mm

Universal Trays, Instrument Trays, Metal Jars
 Mehrzweckschalen, Instrumententablets, Standgefäße
 Bandejas universales, Bandejas para instrumentos, Tarros metálicos
 Plateaux universaux, Plateaux pour instruments, Récipients en métal
 Bacinelle universali, Bacinelle per strumenti, Recipienti metallici



EI-120-23
Universal Tray
 235 x 190 x 40 mm



Instrument Tray
 Without Cover



Instrument Tray
 With Cover

EI-122-01
 150 x 100 x 25 mm

EI-122-05
 350 x 250 x 50 mm

EI-122-02
 200 x 150 x 40 mm

EI-122-06
 350 x 300 x 50 mm

EI-122-03
 250 x 200 x 40 mm

EI-122-07
 400 x 300 x 50 mm

EI-122-04
 250 x 200 x 40 mm

EI-122-08
 450 x 350 x 50 mm

EI-124-01
 150 x 100 x 25 mm

EI-124-05
 350 x 250 x 50 mm

EI-124-02
 200 x 150 x 40 mm

EI-124-06
 350 x 300 x 50 mm

EI-124-03
 250 x 200 x 40 mm

EI-124-07
 400 x 300 x 50 mm

EI-124-04
 250 x 200 x 40 mm

EI-124-08
 450 x 350 x 50 mm



Round Bowls, Metal Jars
Runde Schüsseln, Standgefäße
Cubetas redondas, Tarros metálicos
Cuvettes rondes, Récipients en métal
Scodelle rotonde, Recipienti metallici



EI-130-22
Round Bowl
Ø 220 x 70 mm



Metal Jar

EI-150-30
Ø 30 x 90 mm

EI-150-75
Ø 75 x 100 mm

EI-150-50
Ø 50 x 100 mm

EI-150-76
Ø 75 x 130 mm

EI-150-51
Ø 50 x 130 mm

EI-150-77
Ø 75 x 175 mm

EI-150-52
Ø 50 x 175 mm

EI-150-98
Ø 100 x 175 mm

EI-150-99
Ø 100 x 200 mm



Lid Only

EI-153-50
Ø 50 mm, Closed

EI-150-99
Ø 50 mm, With Triangular Opening

EI-153-75
Ø 75 mm, Closed

EI-150-99
Ø 75 mm, With Triangular Opening

EI-153-99
Ø 100 mm, Closed

EI-150-99
Ø 100 mm, With Triangular Opening

Instrument Trays
Instrumententabletts
Bandejas para instrumentos
Plateaux pour instruments
Bacinelle per strumenti



Instrument Box

EI-200-16

165 x 85 x 35 mm

EI-200-26

260 x 150 x 50 mm

EI-200-20

200 x 100 x 35 mm

EI-200-27

270 x 235 x 50 mm

EI-200-21

200 x 100 x 50 mm

EI-200-30

300 x 200 x 50 mm

EI-200-23

230 x 130 x 50 mm

EI-200-33

325 x 275 x 50 mm

Lid With knob

EI-220-16

165 x 85 x 35 mm

EI-220-30

300 x 200 x 50 mm

EI-220-20

200 x 100 x 35 mm

EI-220-32

324 x 275 x 50 mm

EI-220-21

200 x 100 x 50 mm

EI-220-33

325 x 275 x 50 mm

EI-220-23

230 x 130 x 50 mm

EI-220-42

420 x 80 x 40 mm

EI-220-26

260 x 150 x 50 mm

EI-220-43

420 x 175 x 50 mm

EI-220-27

270 x 235 x 50 mm

Lid Without knob



EI-230-20

Instruments Box
205 x 105 x 35 mm



Dressing Jar

EI-250-06

Ø 75 x 60 mm

EI-254-08

Ø 125 x 80 mm

EI-250-07

Ø 75 x 75 mm

EI-254-12

Ø 125 x 125 mm

EI-252-06

Ø 100 x 60 mm

EI-256-15

Ø 150 x 150 mm

EI-252-10

Ø 100 x 100 mm

Cups
Becher
Tarrós
Réceptifs
Recipienti



Medicine Cup

EI-300-25

25 cc

EI-300-50

50 cc



EI-310-20
Medicine Spoon
20 cc



EI-320-75
Tablet Tray
Ø 75 x 12 mm



EI-350-00
Metal Cup
With Lid
Ø 90 x 90 mm



EI-360-75
Denture Cup
With Lid
Ø 75 x 50 mm



EI-370-75
Sputum Cup
Ø 75 x 80 mm



Kidney Dish

EI-400-17
170 x 100 x 35 mm

EI-400-20
200 x 140 x 38 mm

EI-400-25
250 x 140 x 40 mm

EI-400-27
275 x 150 x 45 mm



EI-402-25
Lid For Kidney Dish
252 mm

Bed Pans, Triangular Basins, Placenta Pan
 Stechbecken, Dreieckschale, Plazentabecken
 Siletas, Cubetas triangulares, Cubeta para placenta
 Bassins réniformes, Bassins triangulaires, Bassin pour placenta
 Bacinelle reniformi, Padelle, Bacinelle triangolari, Bacinella per placenta



EI-500-23
Ø 235 mm

EI-500-31
Ø 310 mm

Bed Pan



EI-510-00
Bed Pan



EI-512-00
Male Urinal



EI-514-00
Female Urinal



EI-520-30
Graduated Triangular Basin
With Handle
600 ml



EI-522-30
Graduated Triangular Basin
Without Handle
600 ml



EI-530-36
Placenta Pan

Our Range of Best Selling Instruments

GENERAL INSTRUMENTS CATALOGUE



+92 (300) 244 1344
www.eva-impex.com
info@eva-impex.com
Alam Chowk, Sialkot 51310 Pakistan.

